

**NO  
TIME  
TO  
DIE** *007™*

**DB5**



# Pack 07

## BUILD INSTRUCTIONS

**STAGE 048: PREPARING THE PASSENGER SEAT BASE**

**STAGE 049: ASSEMBLING THE PASSENGER SEAT**

**STAGE 050: INSTALLING THE EJECTOR MECHANISM**

**STAGE 051: PREPARING THE REAR SEAT BASE**

**STAGE 052: ASSEMBLING THE REAR SEAT**

**STAGE 053: PREPARING THE DASHBOARD**

**STAGE 054: FITTING THE GLOVEBOX, CLOCK AND TEMPERATURE CONTROL**

**STAGE 055: FITTING THE GPS SYSTEM AND RADIO**

**STAGE 056: FITTING THE DASHBOARD DIALS AND SWITCHES**

**STAGE 057: FITTING THE STEERING WHEEL AND DASHBOARD LEDS**

NO TIME TO DIE © Danjaq, LLC and Metro-Goldwyn-Mayer Studios Inc. NO TIME TO DIE, *007™* and related James Bond Indicia © 1962-2024 Danjaq, LLC and Metro-Goldwyn-Mayer Studios Inc. NO TIME TO DIE, *007™* and related James Bond Trademarks are trademarks of Danjaq, LLC. All Rights Reserved.



Aston Martin, the Aston Martin Wings logo and the model name "DB5" are trademarks owned, licensed or used by Aston Martin Lagonda Limited. All Rights Reserved.

AGORAMODELS  
**JAMES BOND**  
—COLLECTION—

## Advice from the experts

---

Spare screws are included with each part. Occasionally, you may be instructed to keep spare or unused screws for a later stage. Keep these spares in a safe place and label them correctly.

Please make sure you don't mix up the screws. They look quite similar, but the threads do vary slightly. Using the wrong screws may damage the parts.

When securing parts together using multiple screws, fit each screw loosely to ensure all the parts are correctly aligned before gently tightening them firmly, but not overtight, in the order in which you placed them.

The screwdriver can be magnetized by stroking it with a magnet (fridge magnet, etc.) enabling it to hold the screws and make assembly easier.

If a screw is tight going into a metal part, do not force it as you may shear the head off. Remove it and put a tiny smear of Vaseline, soap or light oil on the thread. That will lubricate it and make it easier to drive home.

During the course of this build, you will receive many pieces that you will assemble immediately – following the instructions in the corresponding stage – and other pieces that you should store safely to one side, for use in future assembly stages.

Left and Right! When building your *No Time To Die* Aston Martin DB5, the left- or right-hand side refers to that side as if you are sitting in the car.



**WARNING:** Some parts are assembled using magnets. These magnets can cause serious injury if they are swallowed. Keep away from children. If you suspect a magnet has been swallowed, seek medical help straight away.

## Stage 048: Preparing the Passenger Seat Base

In this stage you'll prepare the passenger seat base by fitting the cushion and cover.



### STAGE 048 PARTS LIST

Name
48-A Passenger seat cover
48-B Passenger seat base
48-C Passenger seat cushion



48-A



48-B



48-C

## Stage 048: Preparing the Passenger Seat Base

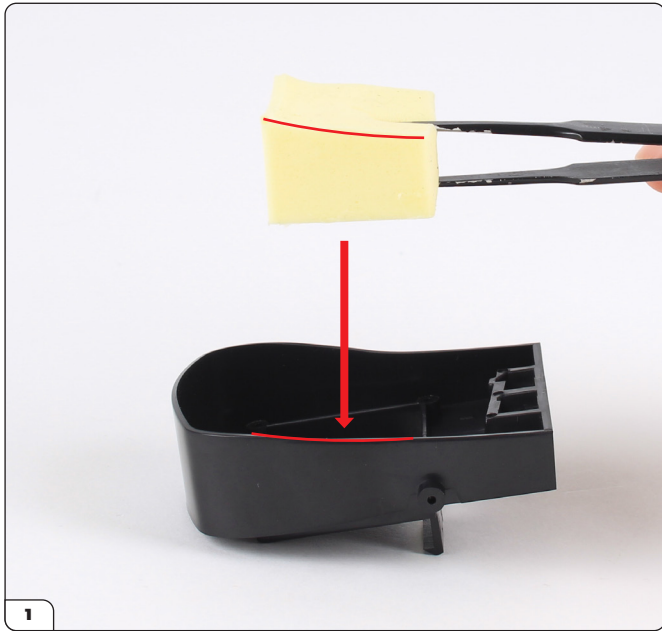

Align the passenger seat cushion (48-C) with the passenger seat base (48-B) as shown.



Fit the cushion in place.



Align the passenger seat cover (48-A) with the base.



Fit the cover onto the seat, lifting the holes on each side over the screw posts.

## Stage 048: Preparing the Passenger Seat Base

---



The cover should look like this once fitted.



## Stage 049: Assembling the Passenger Seat

Next you'll build the backrest by fitting the cover and cushion, then fix it to the base using the brackets.



### STAGE 049 PARTS LIST

Name
49-A Passenger backrest cover
49-B Passenger backrest
49-C Passenger backrest bracket (L1)
49-D Passenger backrest bracket (L2)
49-E Backrest adjuster
PS01 screw x3
PS21 screw x4
PS36 screw x2
PS37 screw x3

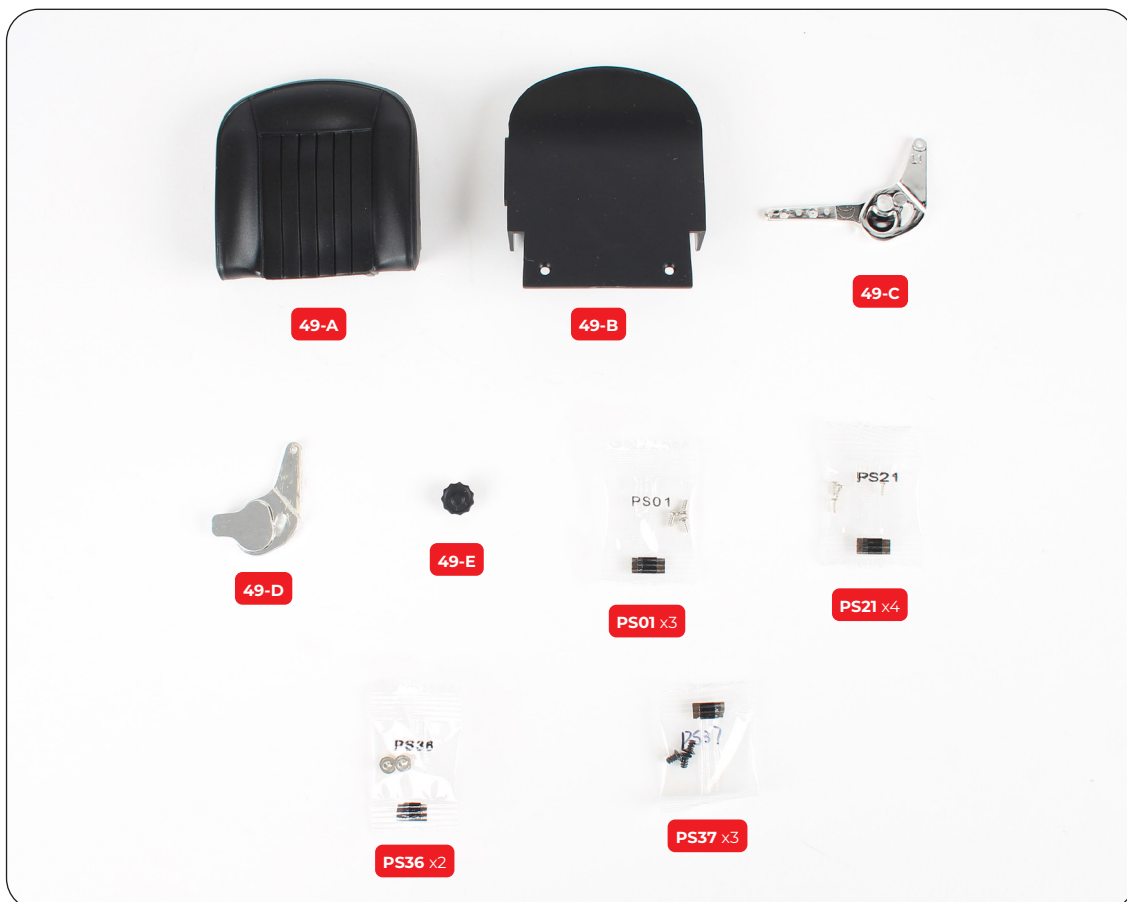

## Stage 049: Assembling the Passenger Seat

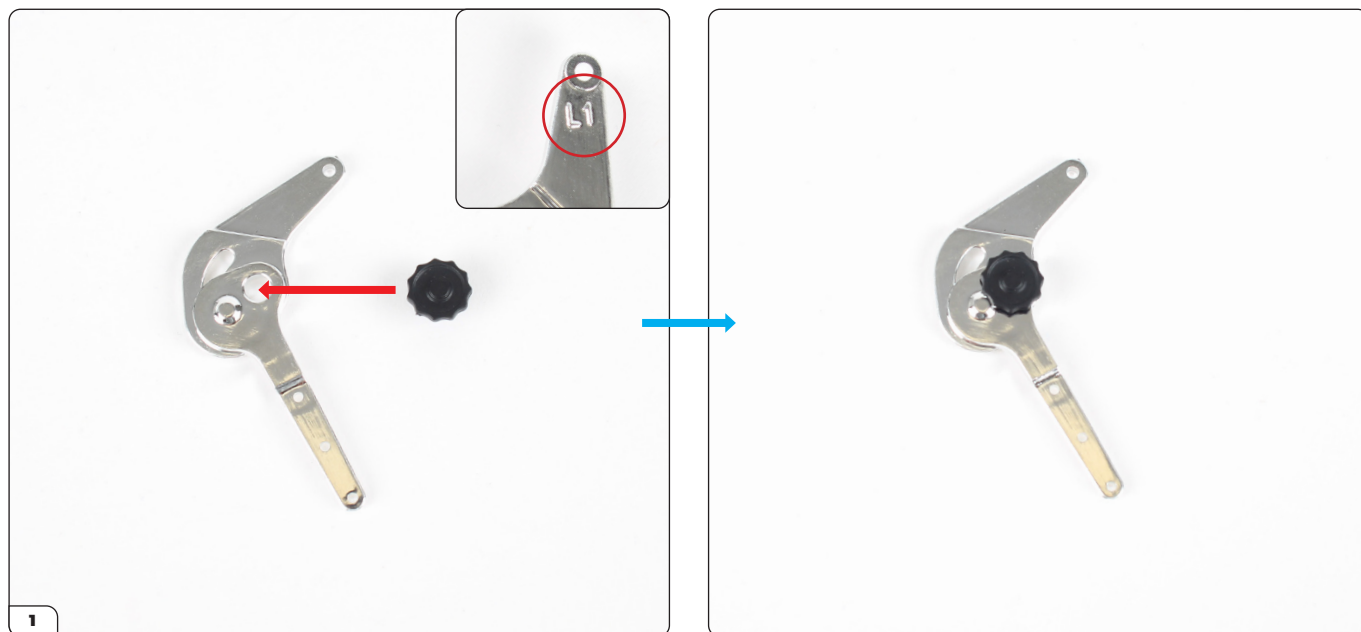

Take the backrest adjuster (49-E) and align it with the passenger backrest bracket (49-C), marked "L1" (inset). Press the adjuster into the hole.



Secure from the other side using a PS36 screw.



Take the passenger backrest cover (49-A) and align it with the passenger backrest (49-B).

## Stage 049: Assembling the Passenger Seat

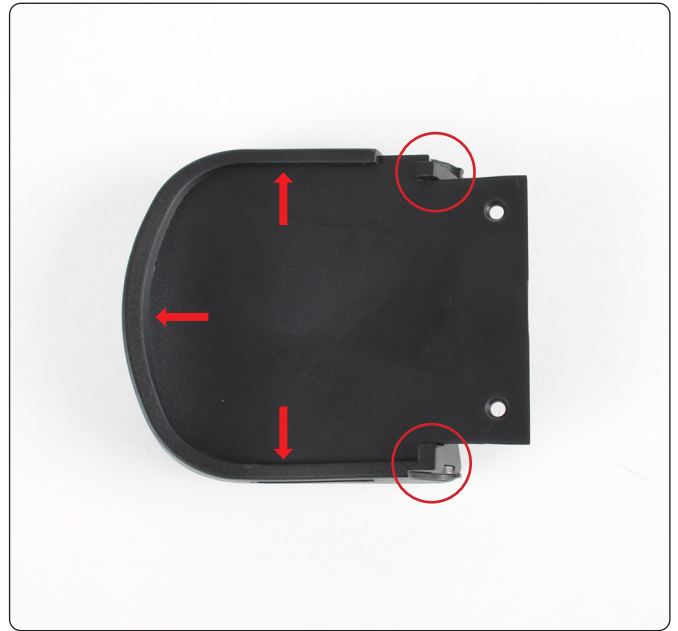

Fit the cover in place as shown. The hooks (circled) and lip (arrows) should wrap over the backrest.

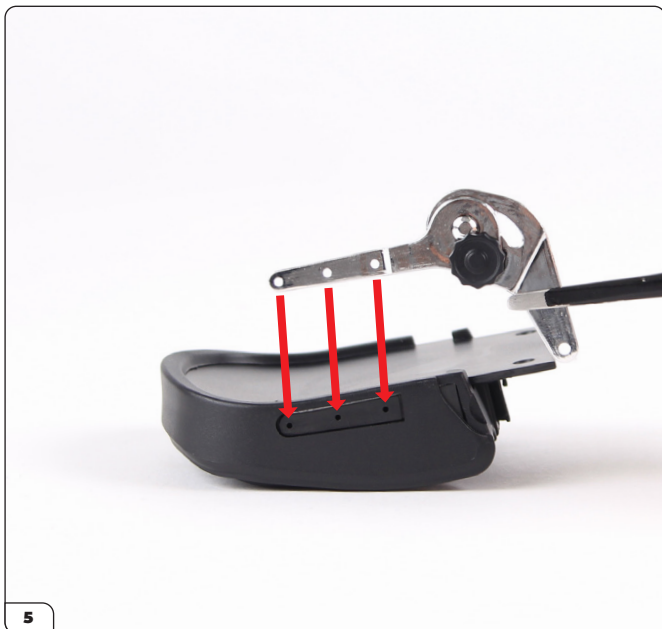

Align the passenger backrest adjuster ("L1") with the three holes on the side of the backrest.

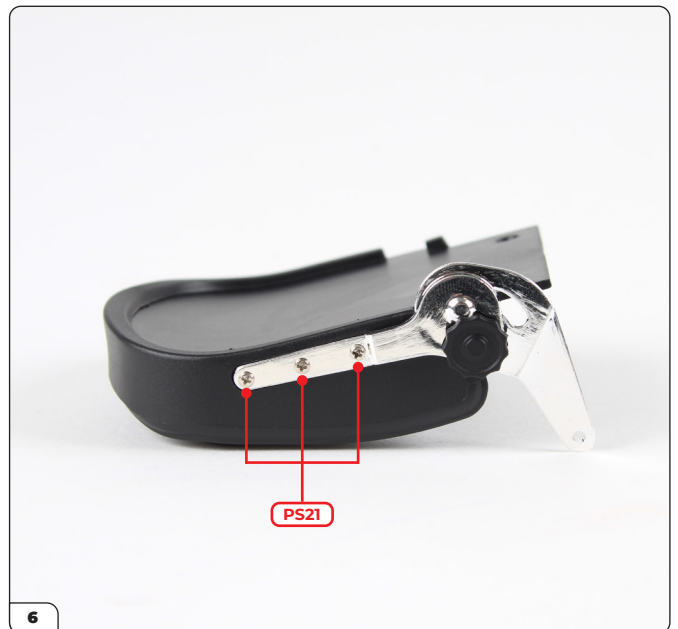

Secure with 3x PS21 screws.



## Stage 049: Assembling the Passenger Seat



Align the backrest with the passenger seat base (stage 048).



Fit the two parts together.



Secure the backrest using 2x PS37 screws.

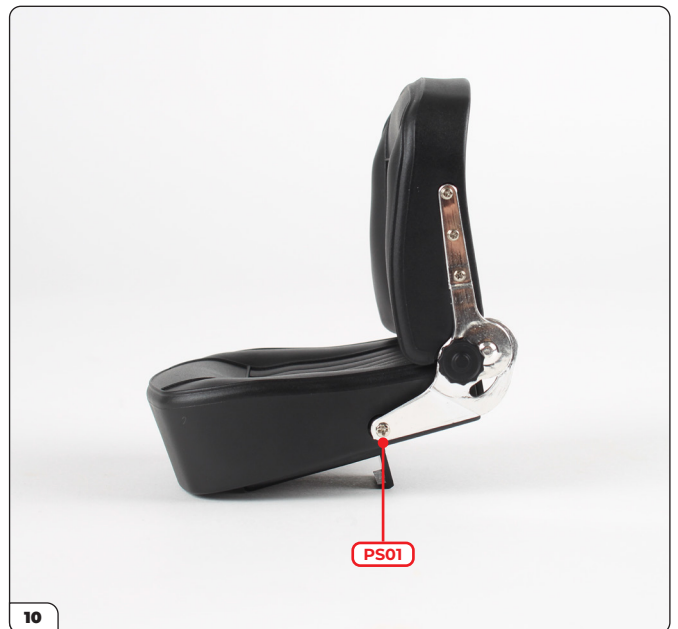

Secure the bracket using a PS01 screw.

## Stage 049: Assembling the Passenger Seat



Take the other passenger backrest bracket (49-D), marked "L2" (inset) and align it with the assembly as shown.



Fit the bracket in place and secure using a PS01 screw.



## Stage 050: Installing the Ejector Mechanism

In this stage you'll install the ejector seat mechanism then test its function with the passenger seat.



### STAGE 050 PARTS LIST

Name
50-A Ejector guide rails
50-B Ejector guide rails cover
50-C Lever
50-D Bracket
50-E Spring
50-F Return spring
PS05 screw x7
PS11 screw x3
DS20 screw x5

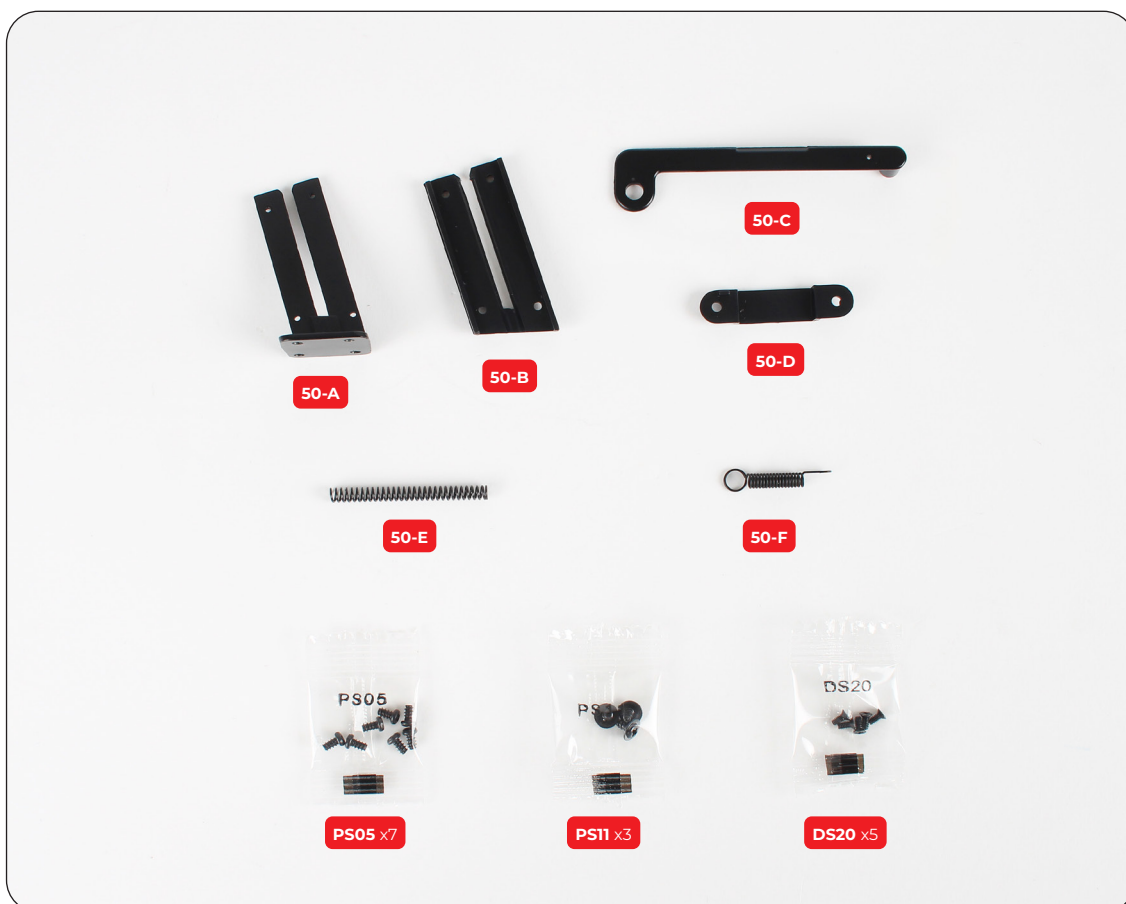

## Stage 050: Installing the Ejector Mechanism



Place the ejector guide rails (50-A) on your work surface as shown then fit the spring (50-E) into the channel.



Align the ejector guide rails cover (50-B) with the assembly. There are four screw holes on each part (circled).

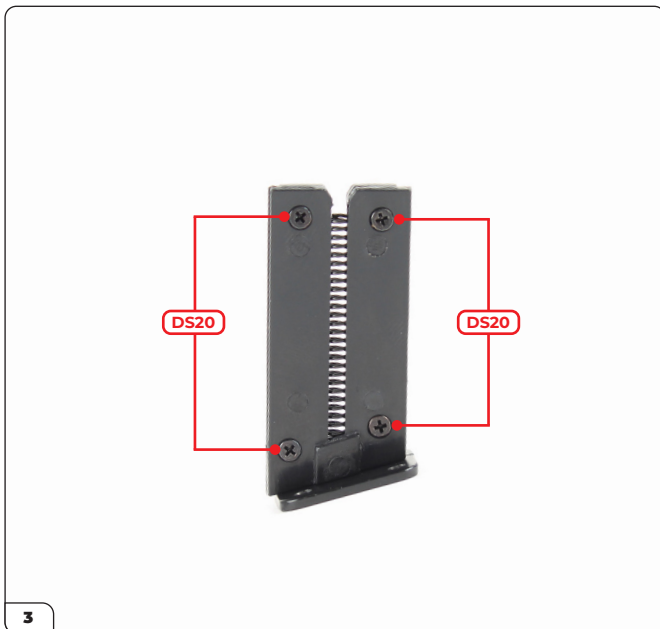

Fit the cover in place and secure using 4x DS20 screws.



Take the return spring (50-F) and fit the hooked end through the small hole on the lever (50-C).

## Stage 050: Installing the Ejector Mechanism

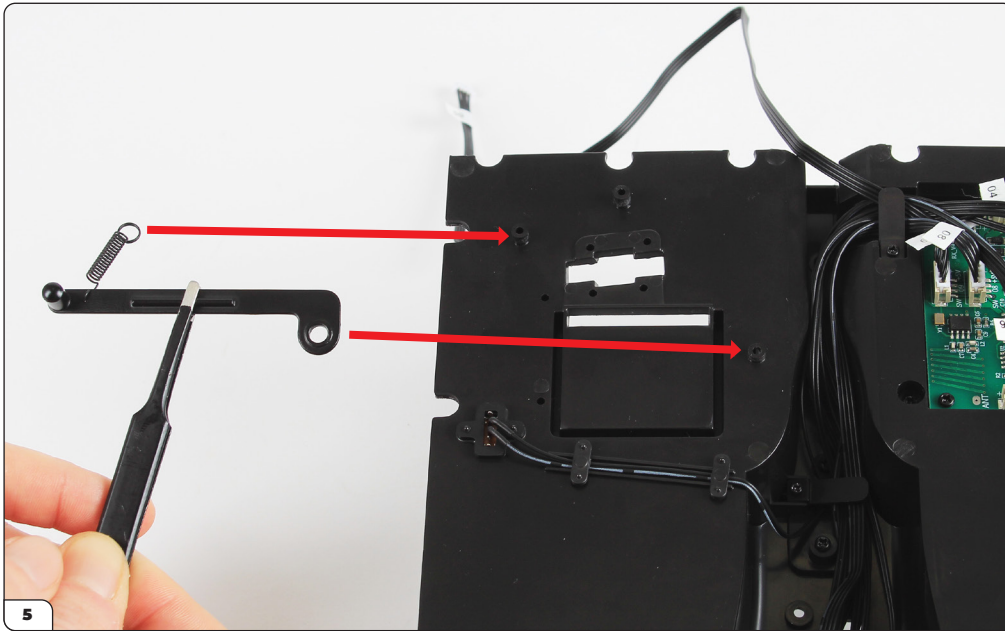

Align the lever and return spring with the cockpit assembly (stage 047).

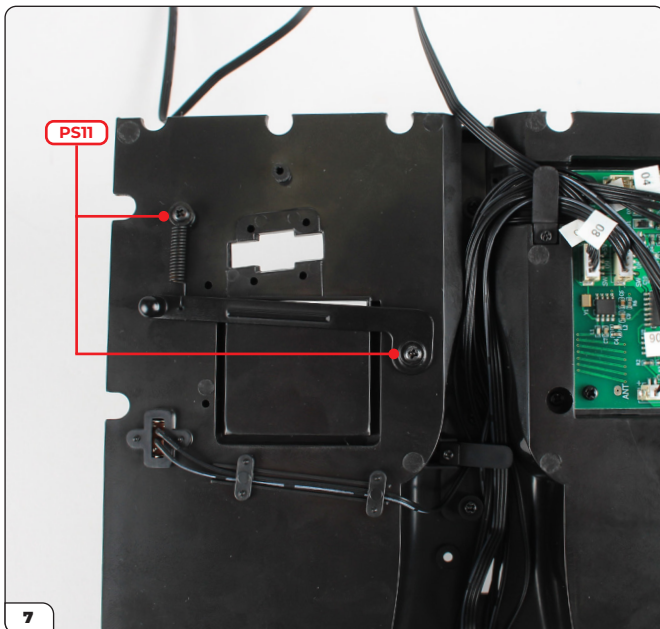

Fit in place then secure using 2x PS11 screws.

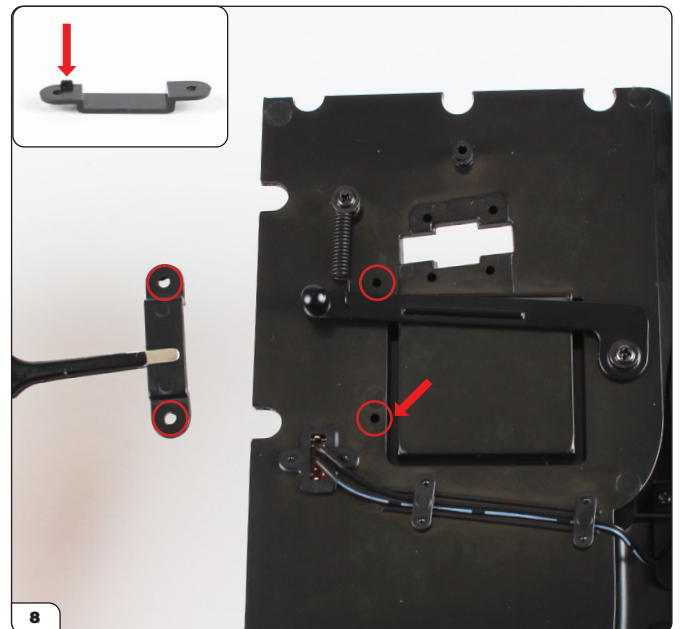

Fit the bracket over the lever. The bracket has a pin (inset) which fits into the recess as indicated by the arrows.

## Stage 050: Installing the Ejector Mechanism

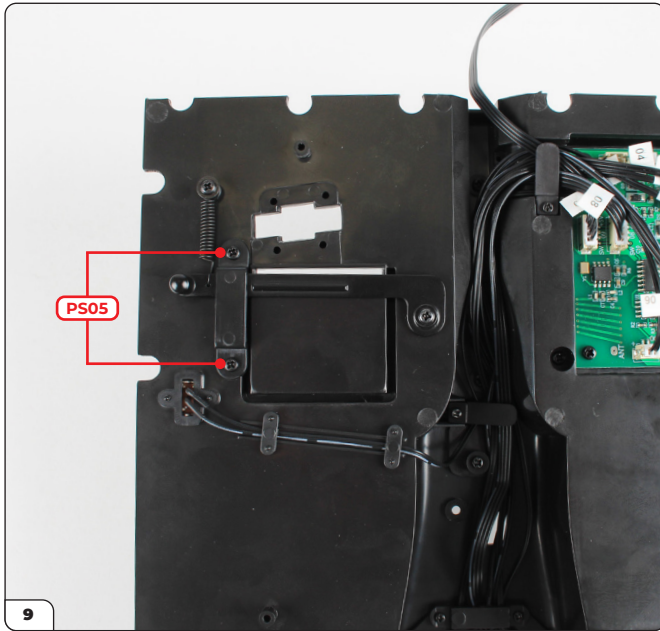

Secure the bracket with 2x PS05 screws.

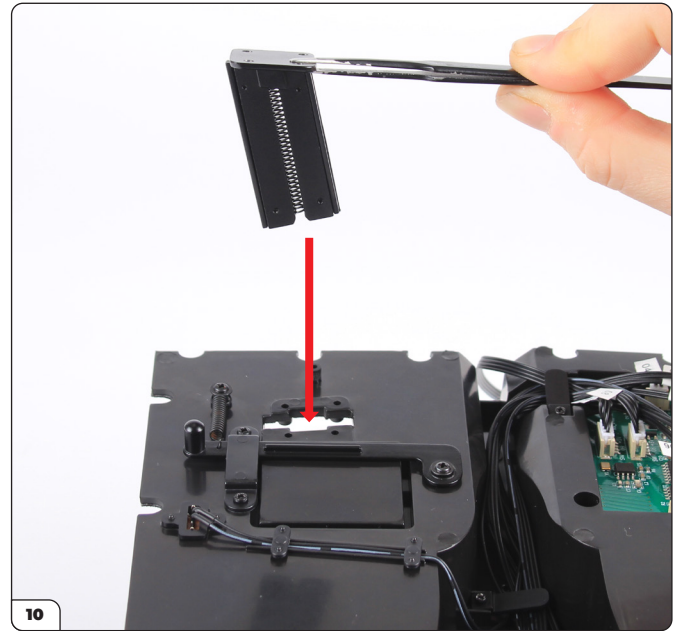

Align the ejector rail guide assembly with the opening next to the lever.

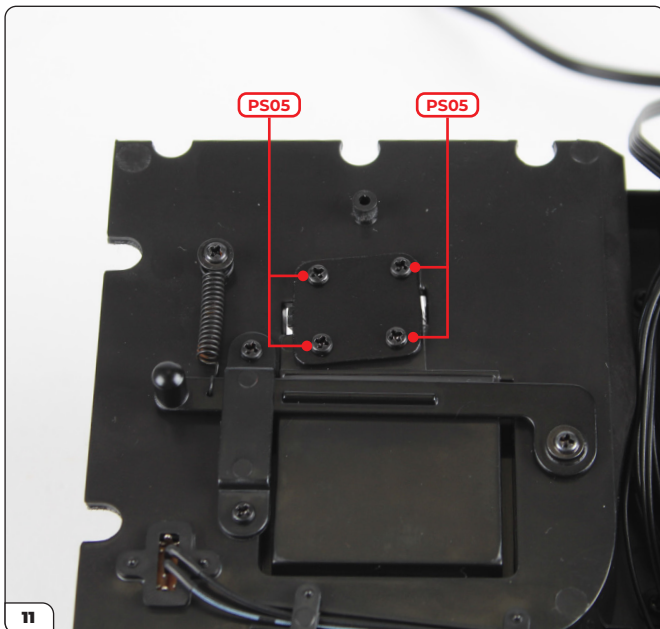

Fit the rail guide through then secure with 4x PS05 screws.



Turn the assembly upright and align the passenger seat (stage 049) with the rail guide.

## Stage 050: Installing the Ejector Mechanism

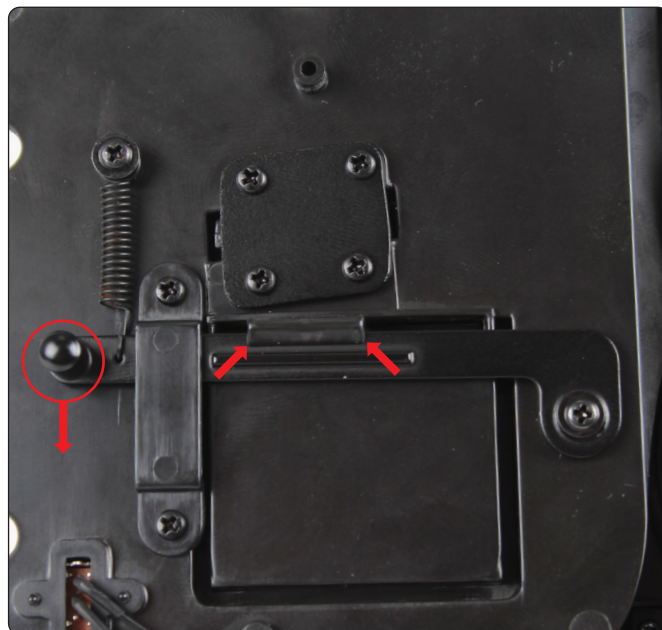

Fit the opening in the passenger seat onto the rail guide then firmly press down until the lever catches the seat (arrows). Pulling the lever handle releases the catch and ejects the seat (circled).



Place the assembly upright to test the ejector mechanism. Pull the lever to release the catch – the seat should shoot upwards at an angle.

## Stage 050: Installing the Ejector Mechanism

STAGE COMPLETE





## Stage 051: Preparing the Rear Seat Base

In this stage you'll prepare the rear seats by fitting the cushion and cover onto the base.



### STAGE 051 PARTS LIST

Name
51-A Rear seat base
51-B Rear seat cover
51-C Rear seat cushion x2



## Stage 051: Preparing the Rear Seat Base

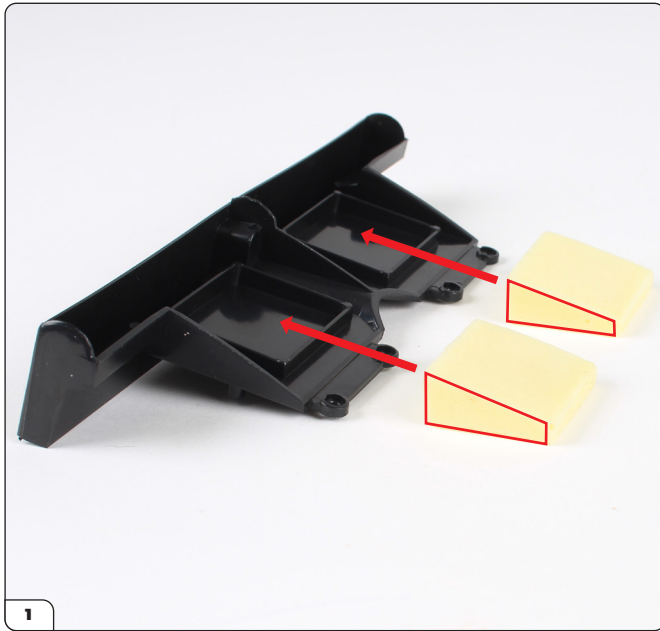

Align the two rear seat cushions (51-C) with the rear seat base (51-A) as shown.



Fit the cushions onto the base.



Align the rear seat cover (51-B) with the base.



Fit the cover in place.

## Stage 051: Preparing the Rear Seat Base



Check that the cover lip is wrapped around the base as shown.



## Stage 052: Assembling the Rear Seat

Next you'll assemble the rear seat by building the backrest and fixing it to the base.



### STAGE 052 PARTS LIST

Name
52-A Rear backrest cover
52-B Rear backrest base
52-C Rear backrest cushion
PS05 screw x5



## Stage 052: Assembling the Rear Seat

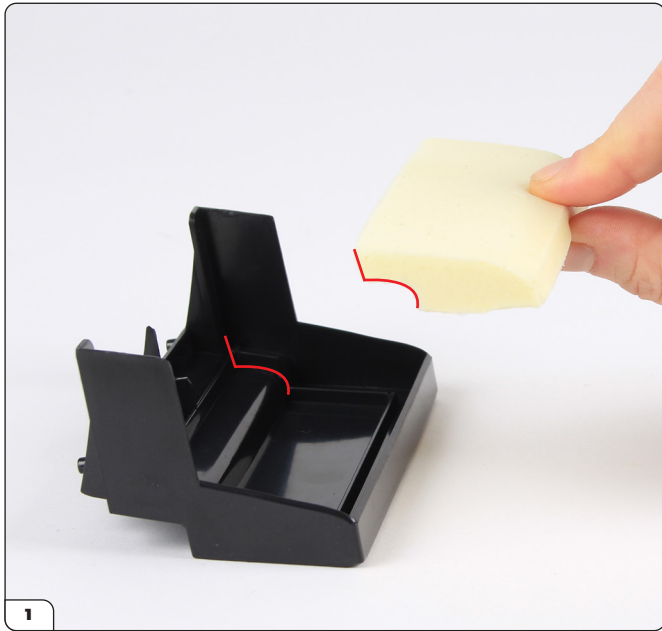

Align the rear backrest cushion (52-C) with the rear backrest base (52-B) as shown.



Fit the cushion in place.



Align the rear backrest cover (52-A) with the base.



Fit the cover in place.

## Stage 052: Assembling the Rear Seat



Check that the cover lip is wrapped around the base as shown (arrows). The four screw posts should fit through the holes (circled).



Align the rear seat base assembly (stage 051) with the four screw posts.



Press the parts together.



Secure with 4x PS05 screws.

## Stage 052: Assembling the Rear Seat

---

STAGE COMPLETE



## Stage 053: Preparing the Dashboard

In this stage you'll start to build the dashboard by fitting two details.



### STAGE 053 PARTS LIST

Name
53-A Dashboard
53-B Dashboard detail (L)
53-C Dashboard detail (R)
PS12 screw x3





## Stage 053: Preparing the Dashboard



Align the left (53-B) and right (53-C) dashboard details with the dashboard (53-A) as shown.

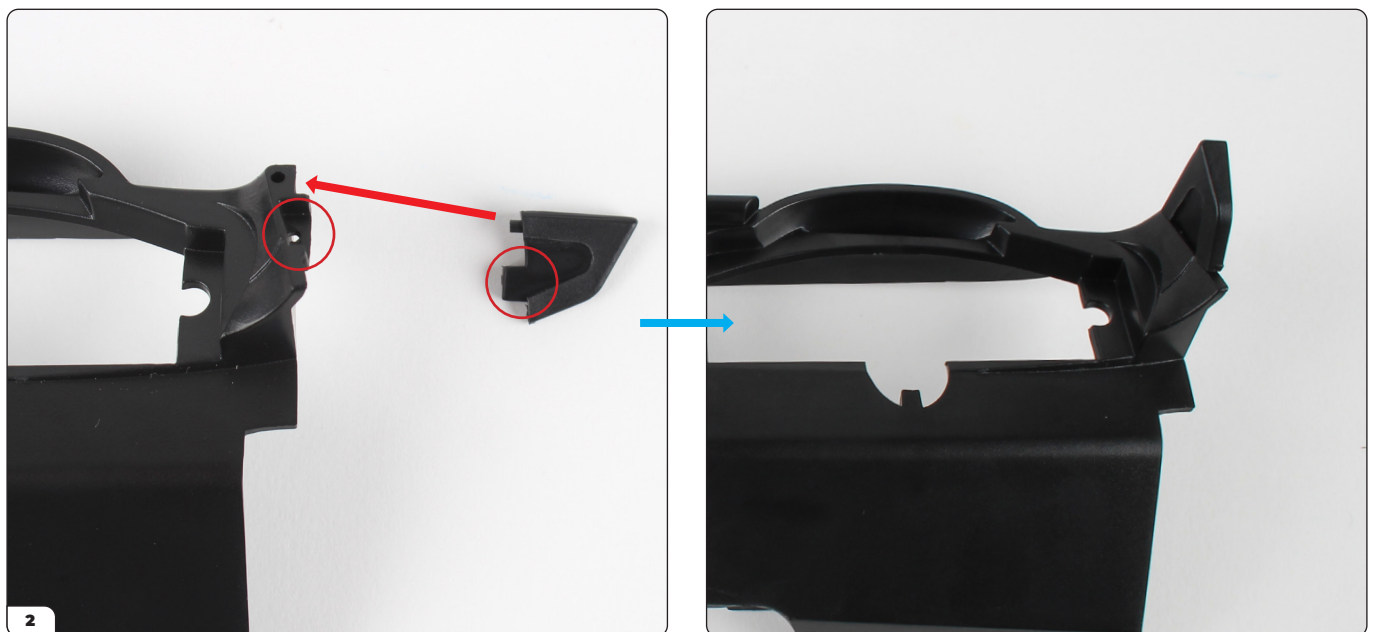

The details have pins that fit into the hole on the dashboard. The plug fits into the recess (circled). Fit the detail in place.

## Stage 053: Preparing the Dashboard



Fit the left detail in the same way.



Use 2x PS12 screws to secure in place.

## Stage 053: Preparing the Dashboard

---

STAGE COMPLETE



# Stage 054: Fitting the Glovebox, Clock and Temperature Control

Next you'll fit the glovebox, clock and temperature control onto the dashboard.



## STAGE 054 PARTS LIST

Name
54-A Glovebox and switches
54-B Glovebox lid
54-C Temperature control
54-D Clock
54-E Clock lens
54-F Switch
54-G Glovebox lid handle
PS05 screw x3
PS12 screw x3



## Stage 054: Fitting the Glovebox, Clock and Temperature Control



Take the glovebox lid handle (54-G) and fit it into the shaped hole of the glovebox lid (54-B).



Secure from the other side with a PS12 screw.

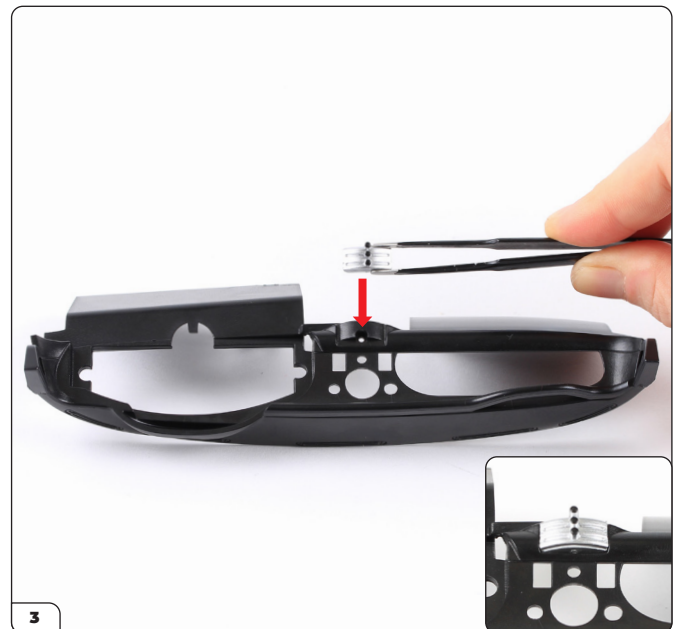

Take the dashboard (stage 053) and fit the temperature control (54-C) onto the shaped mount.

## Stage 054: Fitting the Glovebox, Clock and Temperature Control



Secure from the other side with a PS12 screw.



Align the glovebox lid with the glovebox and switches (54-A).



Fit the lid onto the glovebox.



The glovebox lid can be opened using the handle.

## Stage 054: Fitting the Glovebox, Clock and Temperature Control

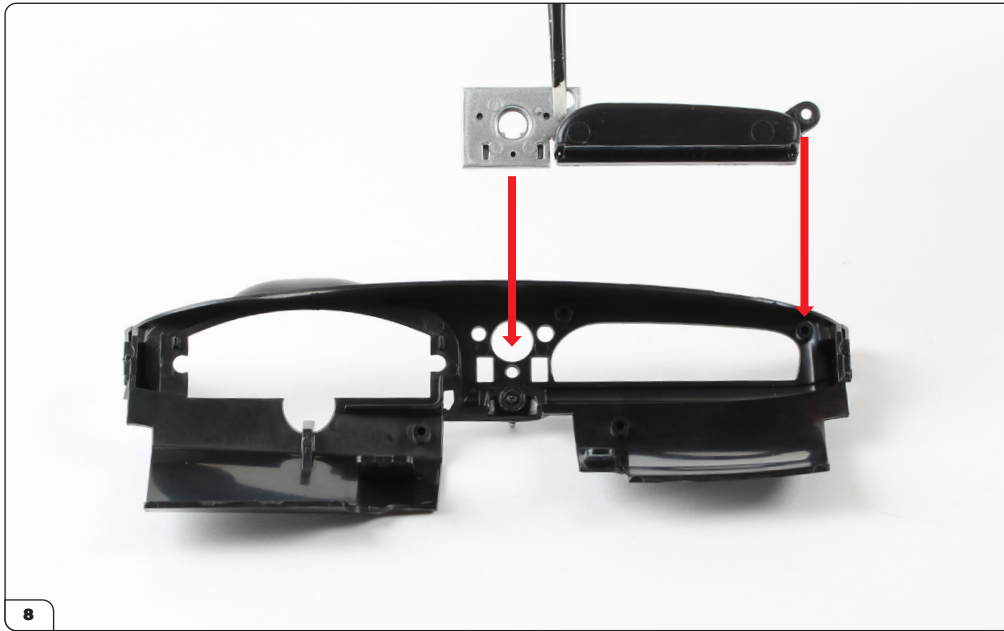

Align the glovebox and switches with the back of the dashboard.

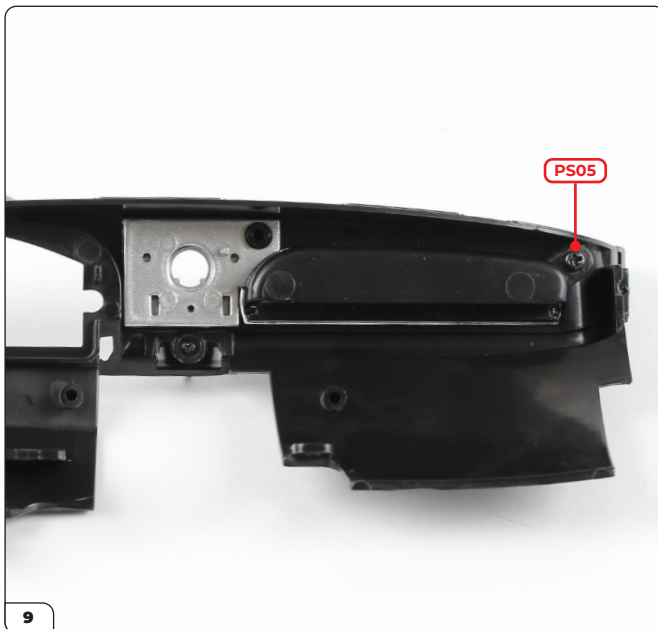

Fit the glovebox in place and secure with a PS05 screw.

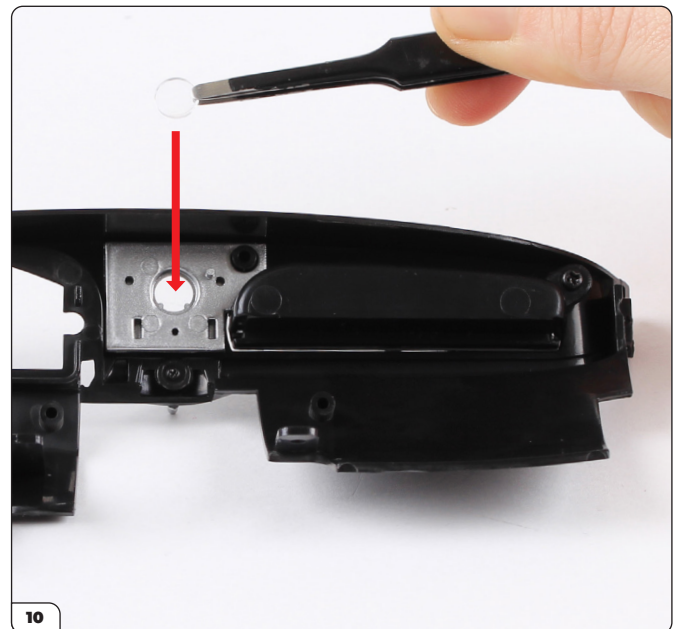

Place the clock lens (54-E) into the hole.

## Stage 054: Fitting the Glovebox, Clock and Temperature Control

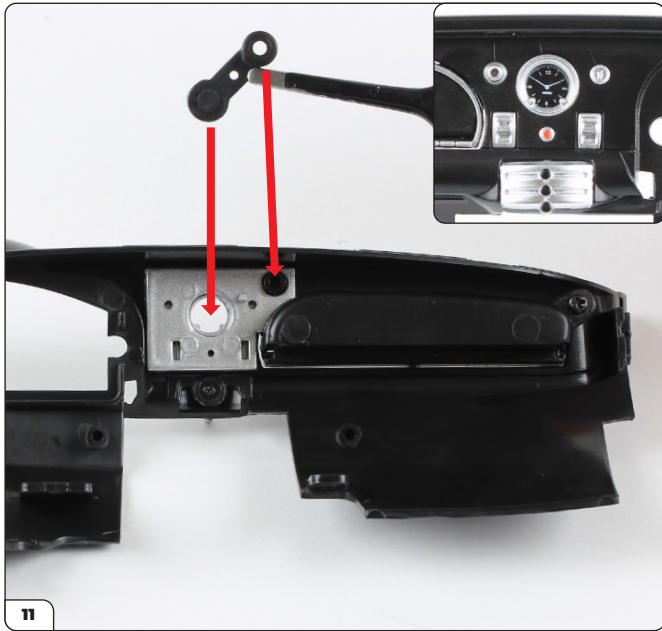

Fit the clock (54-D) in place so that the clock faces outwards (inset).

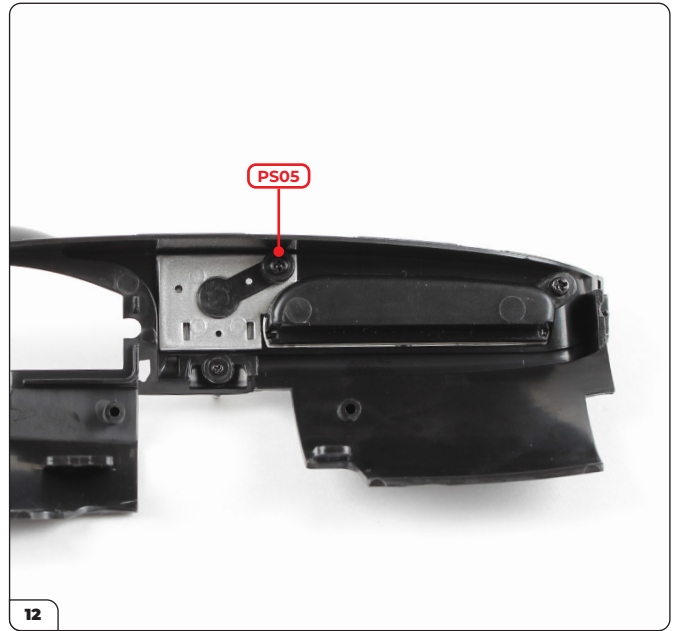

Secure using a PS05 screw.

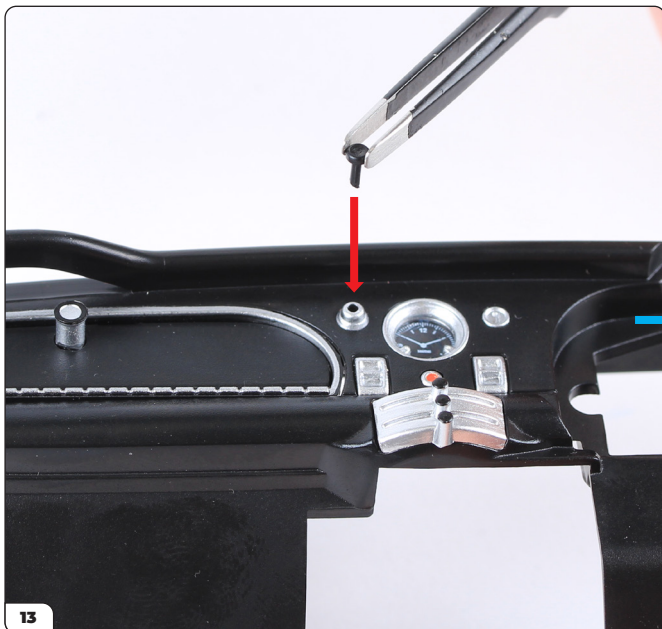

Push the switch (54-F) into the front of the dashboard as shown.





## Stage 054: Fitting the Glovebox, Clock and Temperature Control

---

STAGE COMPLETE



## Stage 055: Fitting the GPS System and Radio

In this stage you'll build the GPS system then fit it to the dashboard along with the radio.



### STAGE 055 PARTS LIST

Name
55-A GPS housing
55-B GPS cover
55-C GPS glass
55-D Radio
55-E GPS reflector
GPS sticker
Radio sticker
PS04 screw x2
PS05 screw x5



## Stage 055: Fitting the GPS System and Radio

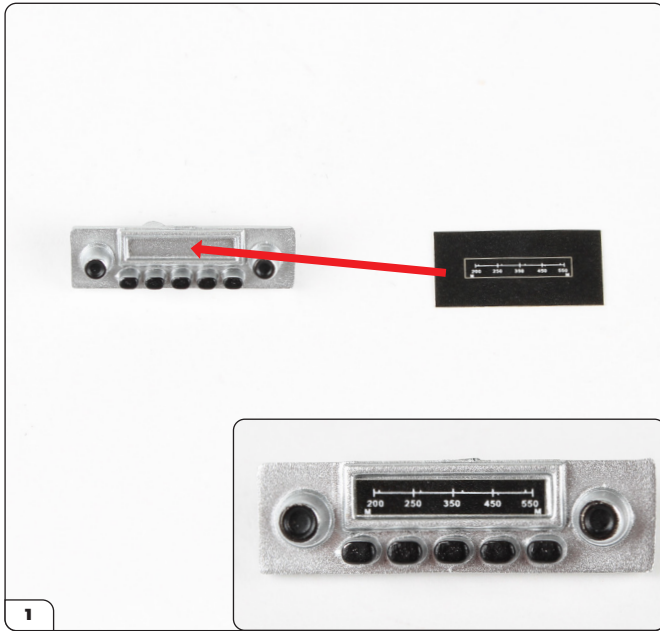

Take the radio (55-D) and radio sticker. Peel the sticker and fit it onto the radio in the orientation shown (inset).

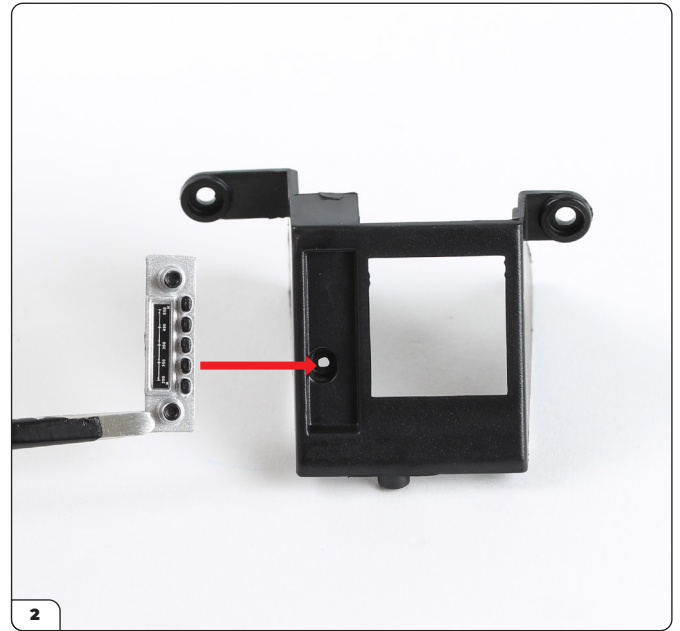

Fit the radio into the GPS housing (55-A).



Secure with a PS04 screw.

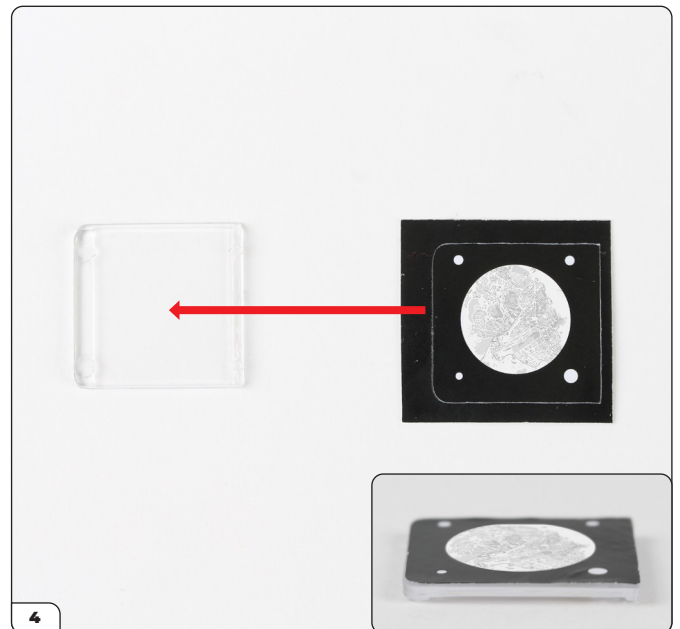

Place the GPS sticker onto the flat side of the GPS glass (55-C). Note that two of the corners are rounded to help align the sticker correctly.

## Stage 055: Fitting the GPS System and Radio

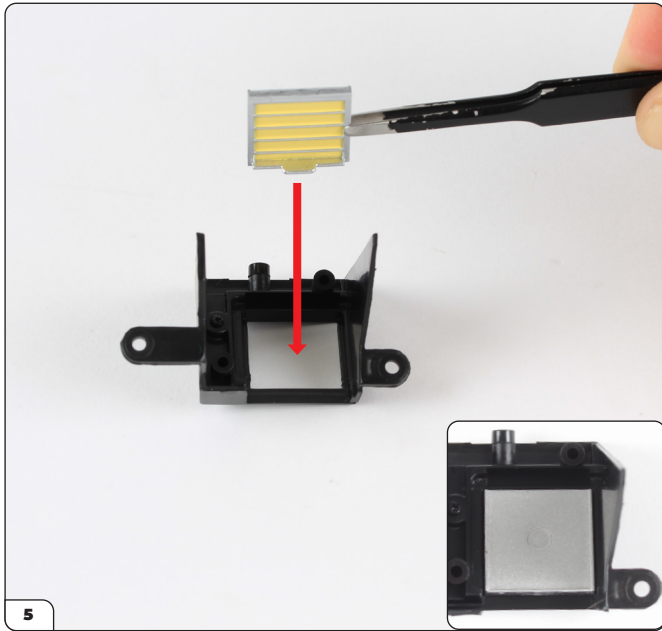

Align the GPS cover (55-B) with the housing as shown and place it into the square opening.

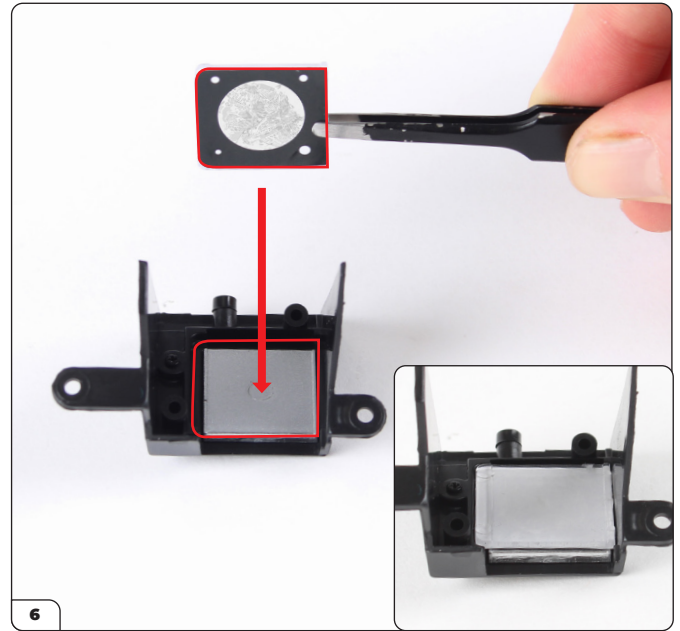

Place the GPS glass onto the cover. The recess is shaped the same way as the glass (red outline).

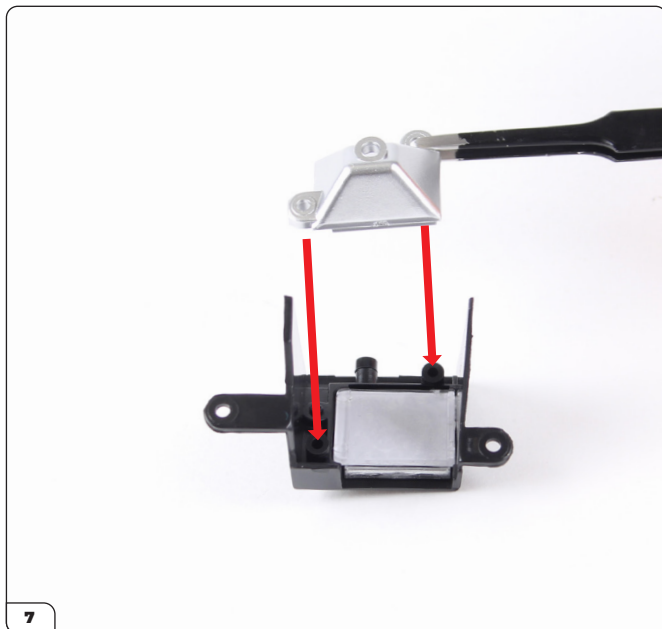

Align the GPS reflector (55-E) with the screw holes on the housing.

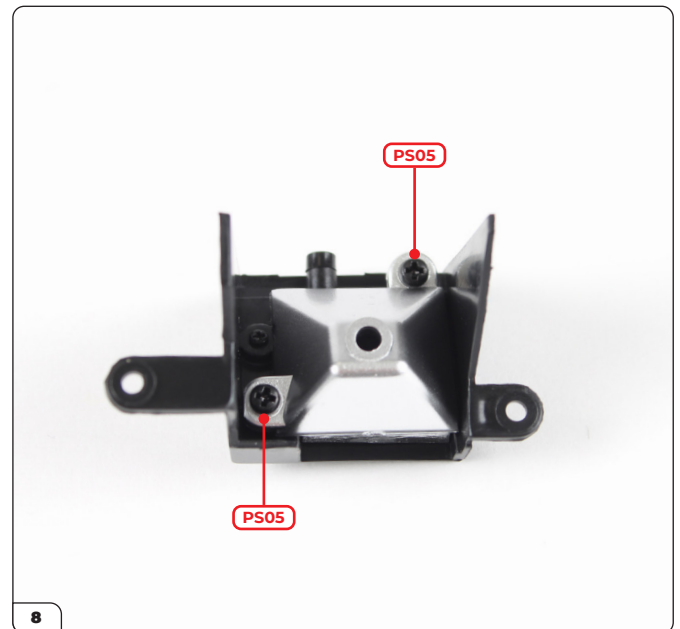

Fit in place and secure with 2x PS05 screws.

## Stage 055: Fitting the GPS System and Radio



Check the GPS cover slides open as shown to reveal the screen beneath.

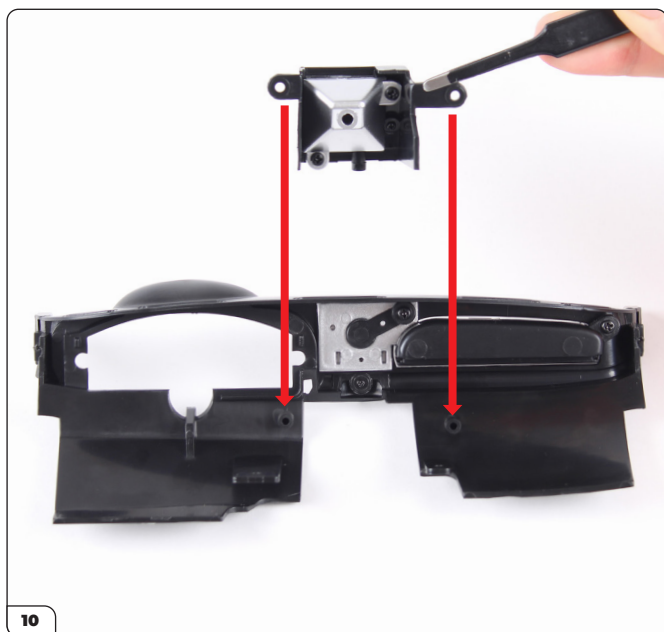

Align the housing with the dashboard and fit onto the screw posts.

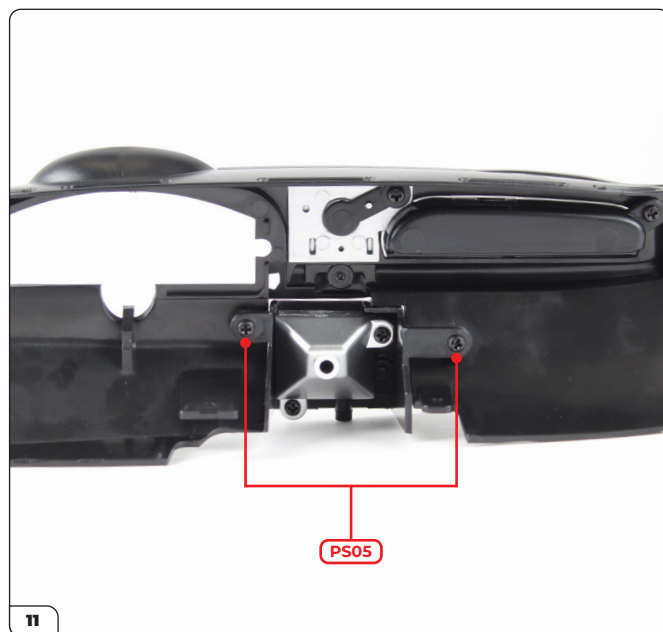

Secure with 2x PS05 screws.

## Stage 055: Fitting the GPS System and Radio

STAGE COMPLETE



# Stage 056: Fitting the Dashboard Dials and Switches

To complete the dashboard, you'll fit the dials and switches to the instrument panel.



## STAGE 056 PARTS LIST

Name
56-A Dial housing
56-B Dial lenses
56-C Dial reflector
56-D Dial mount
56-E Dial trim
56-F Air vent switch
56-G Switch x3
Dial stickers
PS02 screw x3
PS21 screw x4



## Stage 056: Fitting the Dashboard Dials and Switches



Take the dial mount (56-D) and the dial stickers. Note the shaped corner that matches the outline on the sticker sheet.



Peel the dial stickers and fit them onto the matching spots on the dial mount.



Align then fit the dial trim (56-E) onto the dial housing (56-A).





## Stage 056: Fitting the Dashboard Dials and Switches

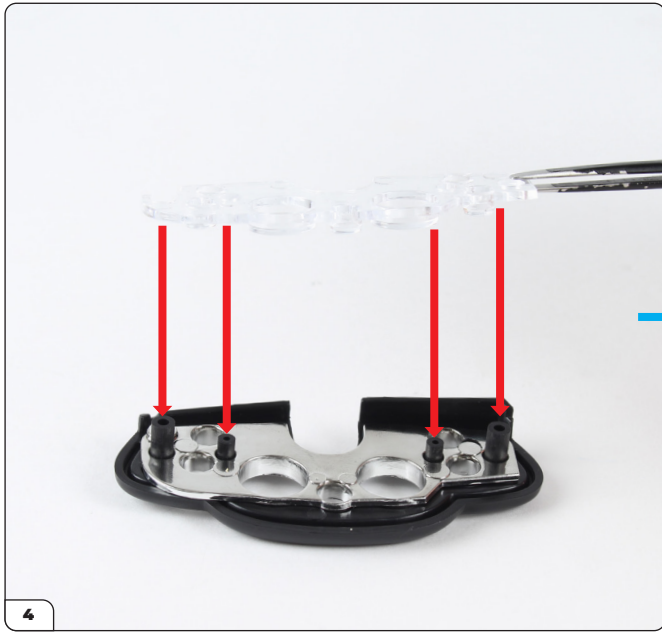

Align then fit the dial lenses (56-B) onto the housing.

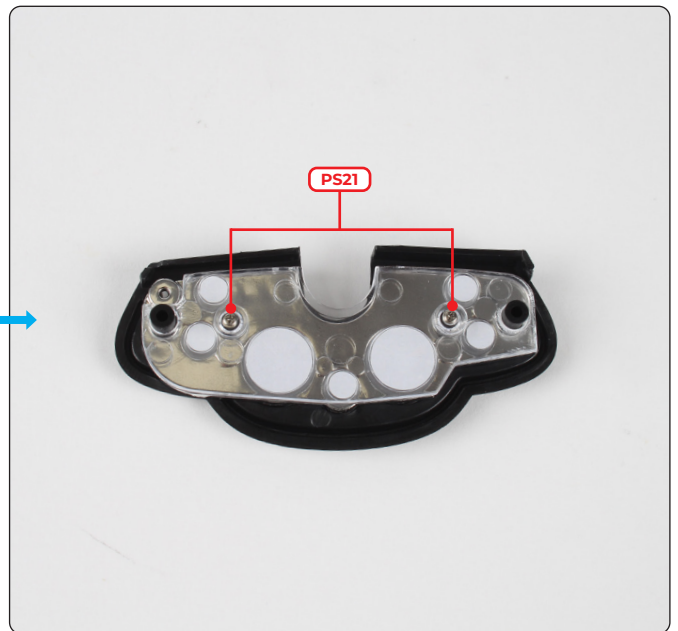

Fit the dial mount with the applied stickers onto the housing then secure with 2x PS21 screws.

## Stage 056: Fitting the Dashboard Dials and Switches



Fit the air vent switch (56-F) into the shaped hole in the housing.



Secure from the other side with a PS21 screw.



Align the housing with the dashboard (stage 055) as shown.

## Stage 056: Fitting the Dashboard Dials and Switches



Push the housing in place.

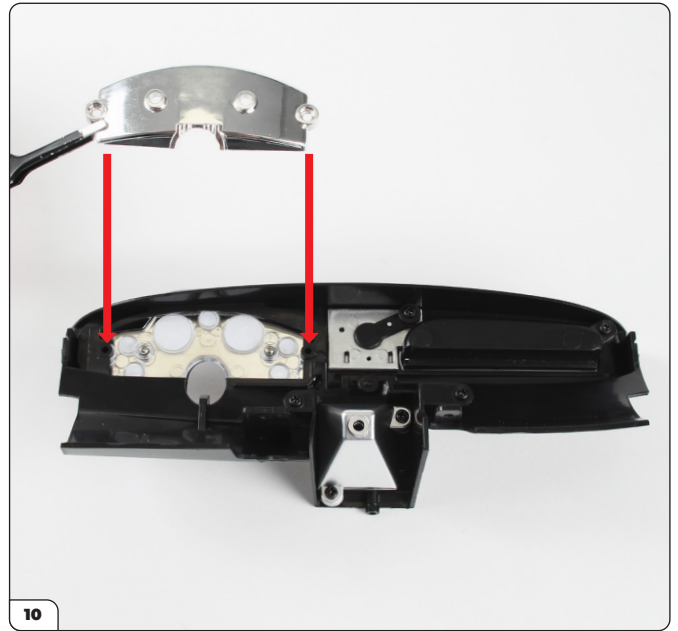

Align the dial reflector (56-C) with the dashboard as shown.

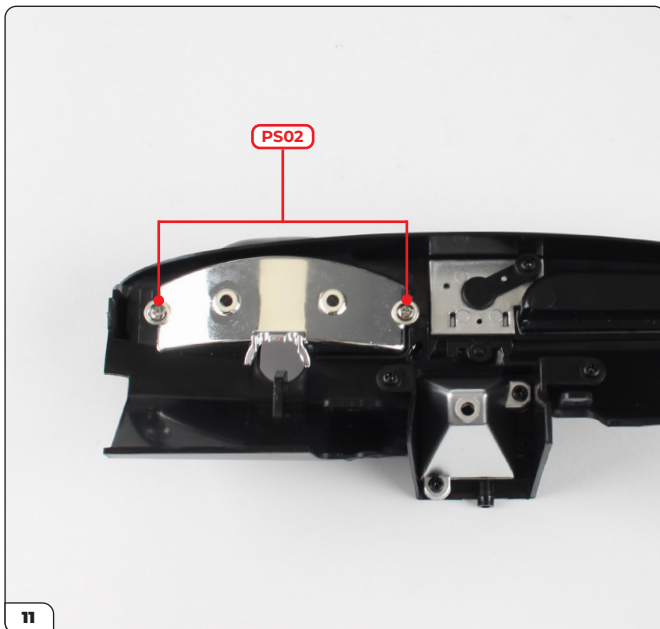

Fit the reflector onto the screw posts then fix in place with 2x PS02 screws.



The three switches (56-G, inset) fit into the holes in the housing (circled).

## Stage 056: Fitting the Dashboard Dials and Switches



Push the three switches into the holes.



# Stage 057: Fitting the Steering Wheel and Dashboard LEDs

In this stage you'll assemble the steering wheel and fit it onto the dashboard, then mount them onto the cockpit assembly. You'll also connect the remaining wires to the circuit board and fit the instrument panel LEDs.



## STAGE 057 PARTS LIST

Name	Name
57-A Steering wheel	57-H Power supply wire '12'
57-B Steering column	57-I Rear light wire '13'
57-C Steering column cover (left)	57-J Rear light wire '14'
57-D Steering column cover (right)	PS05 screw x4
57-E Steering wheel badge	PS09 screw x2
57-F Wire bracket	PS12 screw x5
57-G Dashboard LEDs wire '11'	

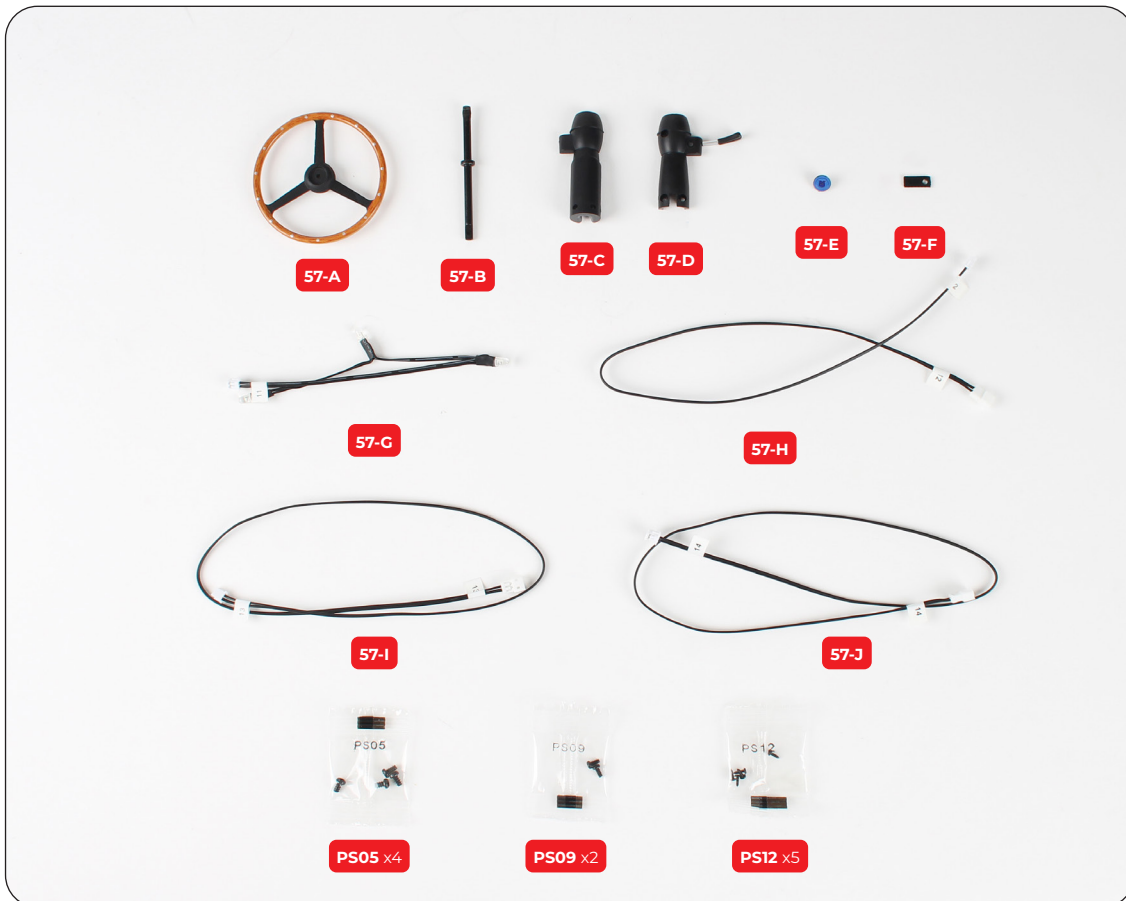

## Stage 057: Fitting the Steering Wheel and Dashboard LEDs

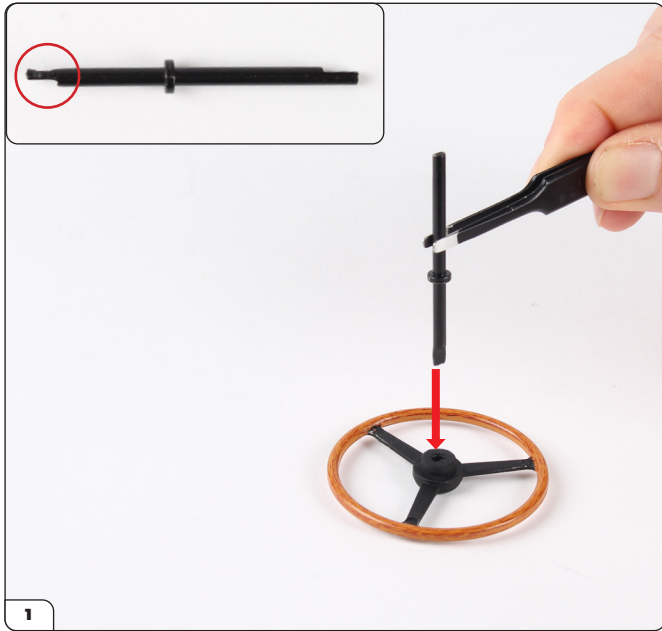

Take the steering column (57-B) and place the thin end without a hole (inset) into the shaped hole of the steering wheel (57-A).



Carefully hammer the steering column into the steering wheel.

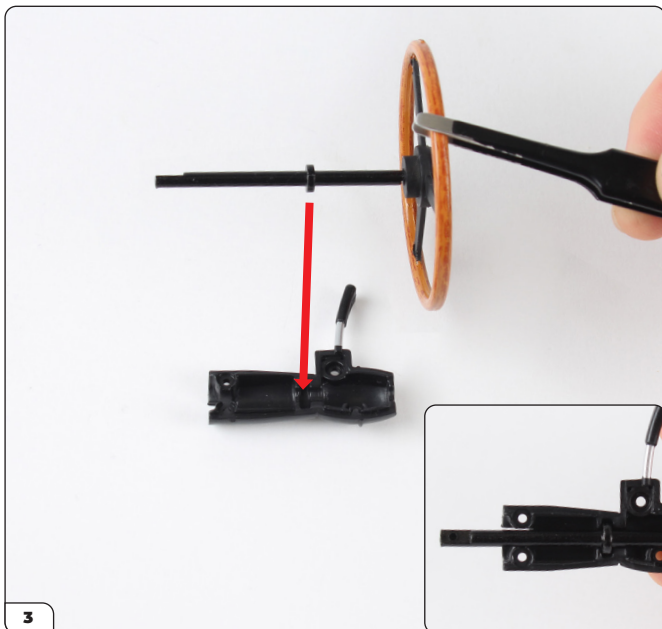

Align the steering wheel with the right steering column cover (57-D) then position the steering column into the shaped recess.

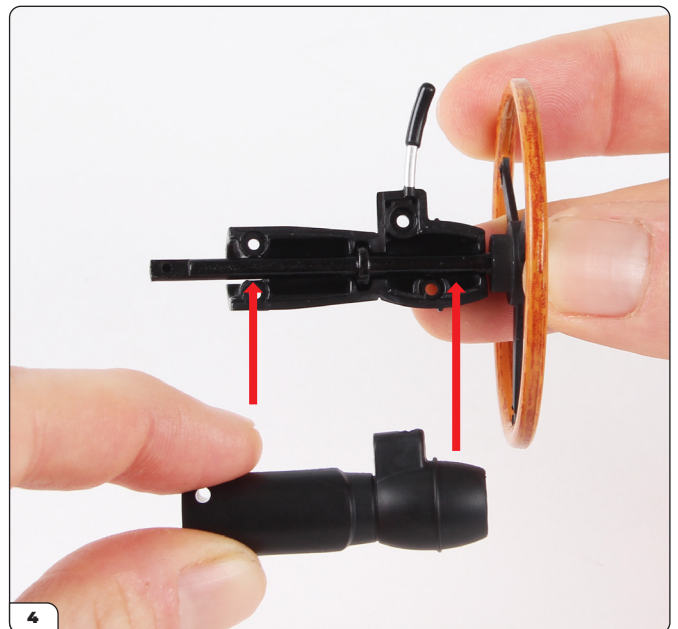

Fit the left steering column cover (57-C) onto the right part.

## Stage 057: Fitting the Steering Wheel and Dashboard LEDs

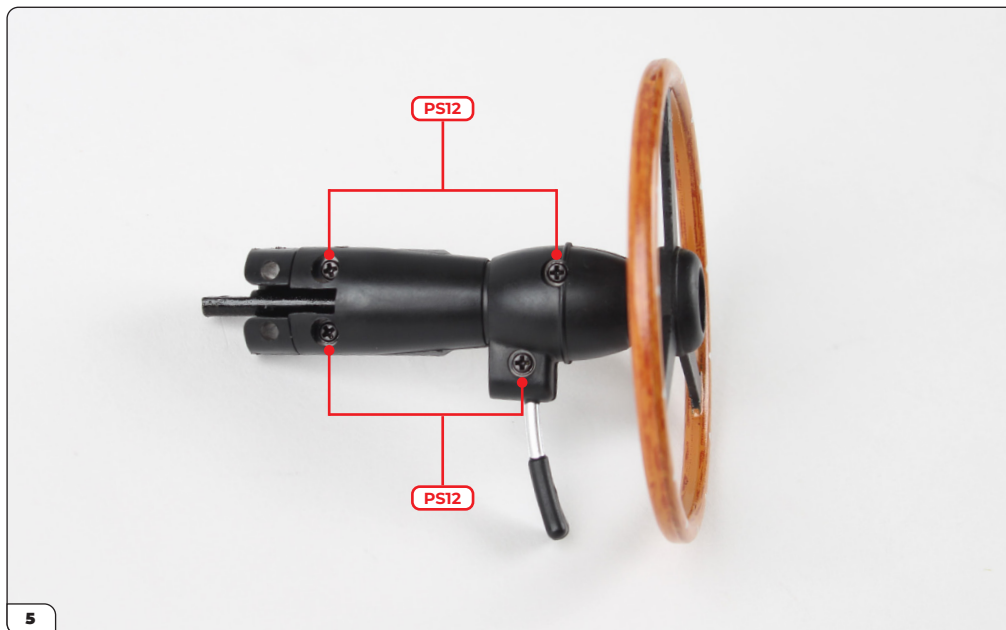

Fix the parts together with 4x PS12 screws.

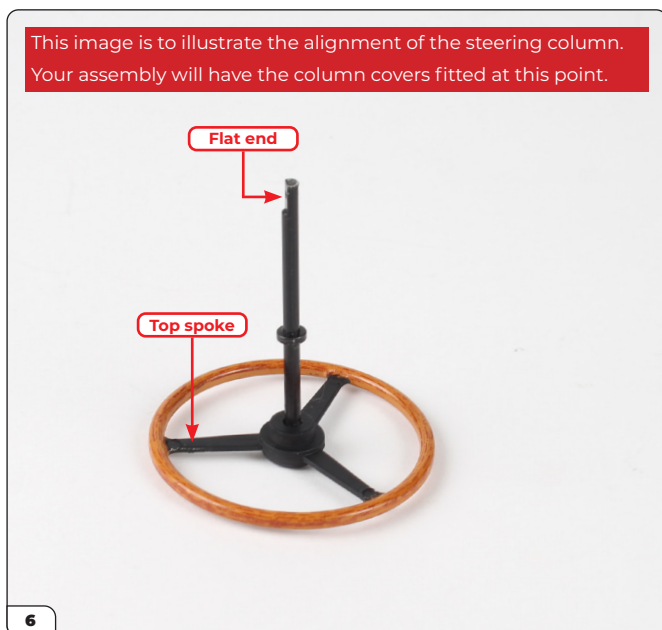

The flat end of the steering column align with the top spoke of the wheel (left image). Align the steering wheel badge (57-E) with the steering wheel then press into the recess. The badge should align with the top spoke (inset).

## Stage 057: Fitting the Steering Wheel and Dashboard LEDs



Fit the steering wheel cover into the dashboard (stage 056). The hole is shaped to ensure the correct orientation.

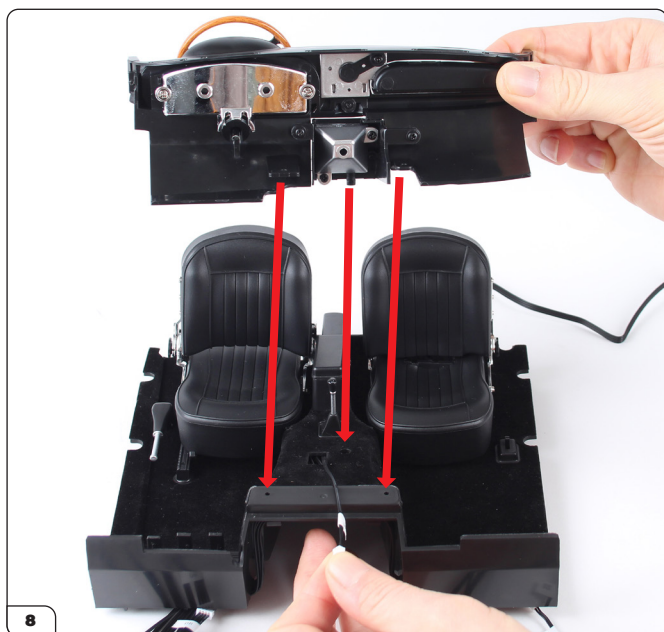

Take the cockpit floor assembly. Hold the instrument panel wire (marked '11') towards the front then align the dashboard assembly as shown.

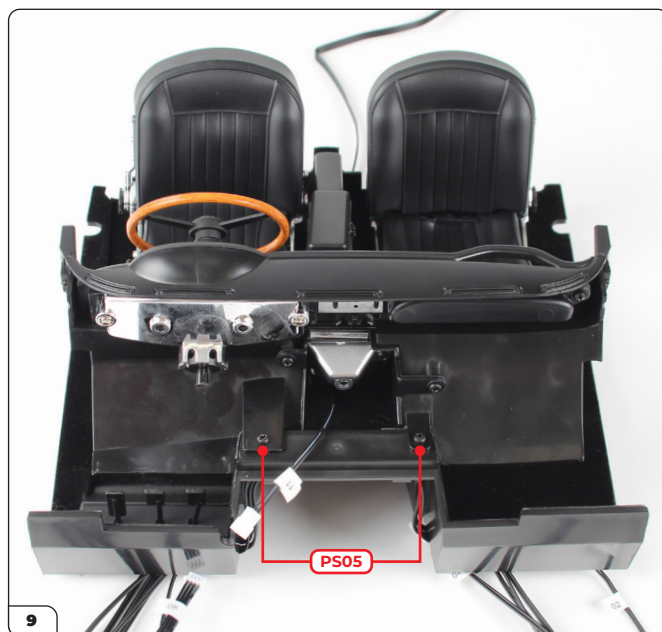

Fit the dashboard in place then secure the two tabs using 2x PS05 screws.



## Stage 057: Fitting the Steering Wheel and Dashboard LEDs

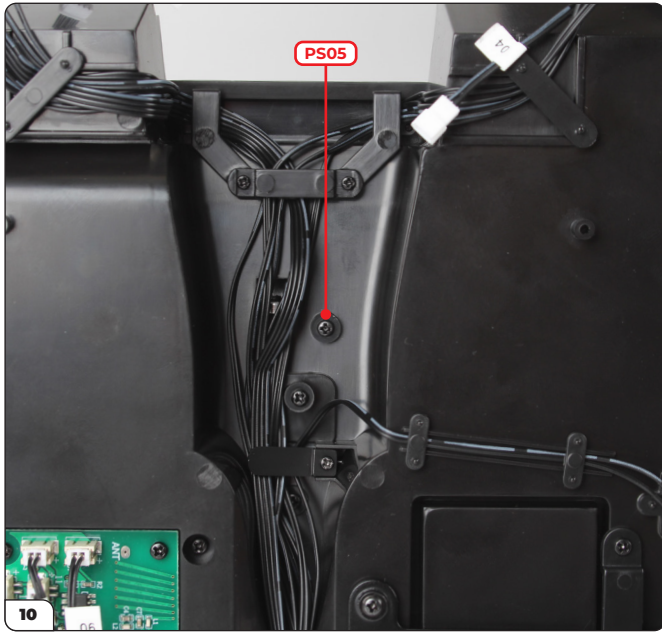

Secure the GPS housing to the cockpit by driving a PS05 screw into it from underneath.

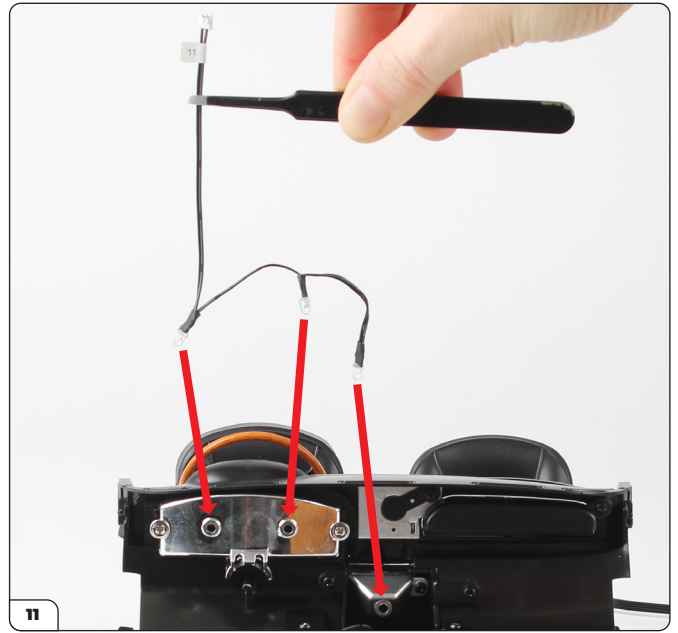

Take the dashboard LEDs wire ('11') and fit the three bulbs into the dials and GPS reflectors as shown.

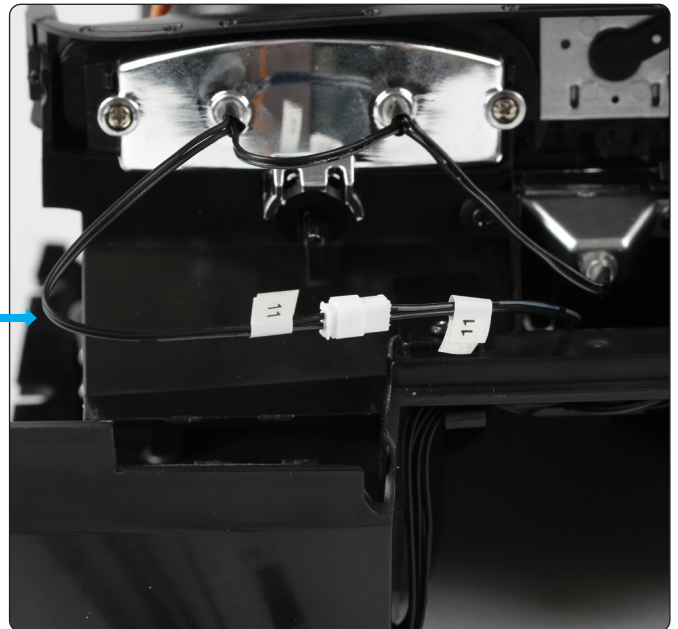
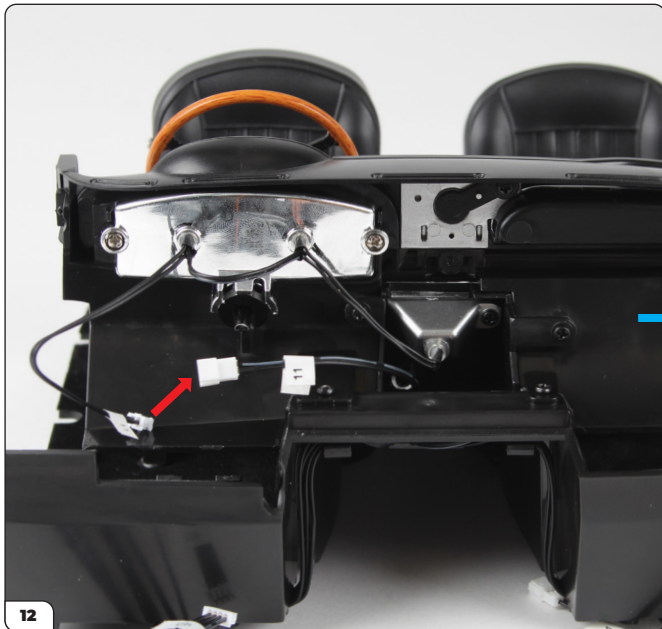

The bulbs should look like this once fitted. Connect the two wires marked '11' together.

# Stage 057: Fitting the Steering Wheel and Dashboard LEDs

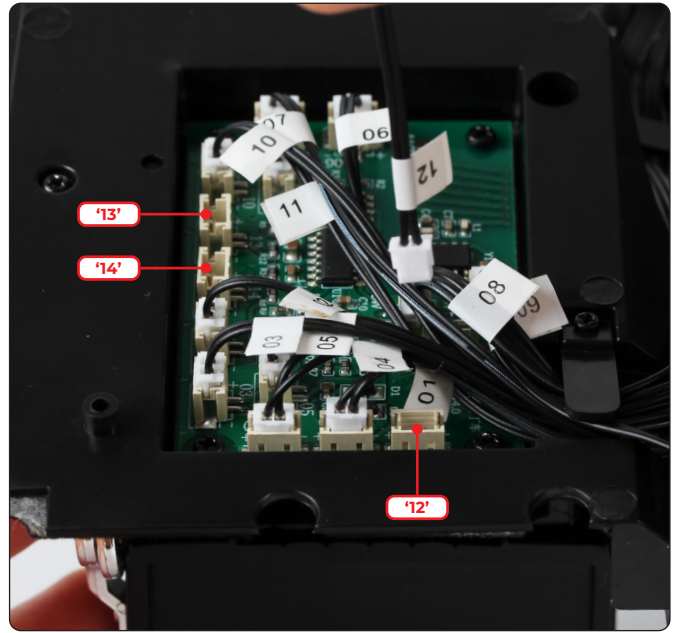
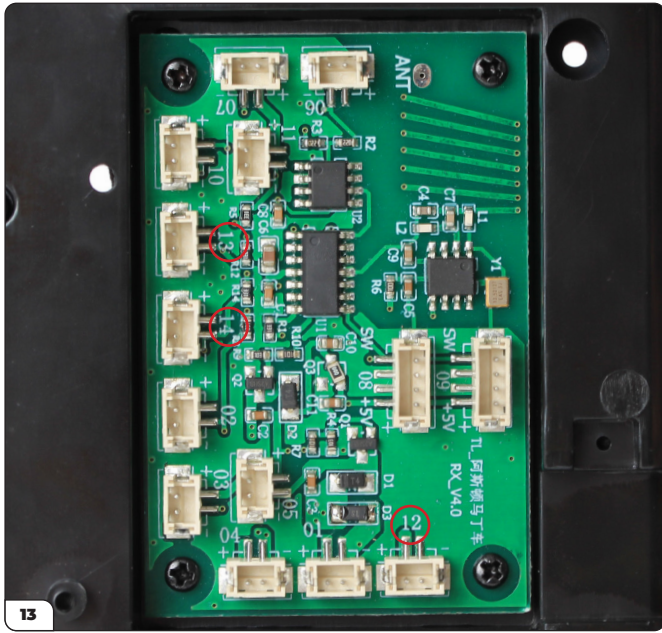

Next you'll connect the remaining wires to the circuit board. Sockets 12, 13 and 14 have been highlighted in the images.

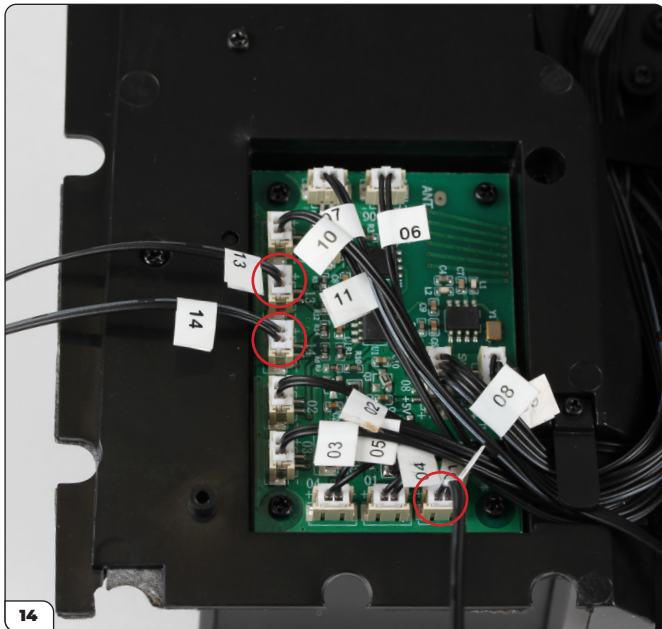

Plug wires '12', '13' and '14' into the corresponding sockets.

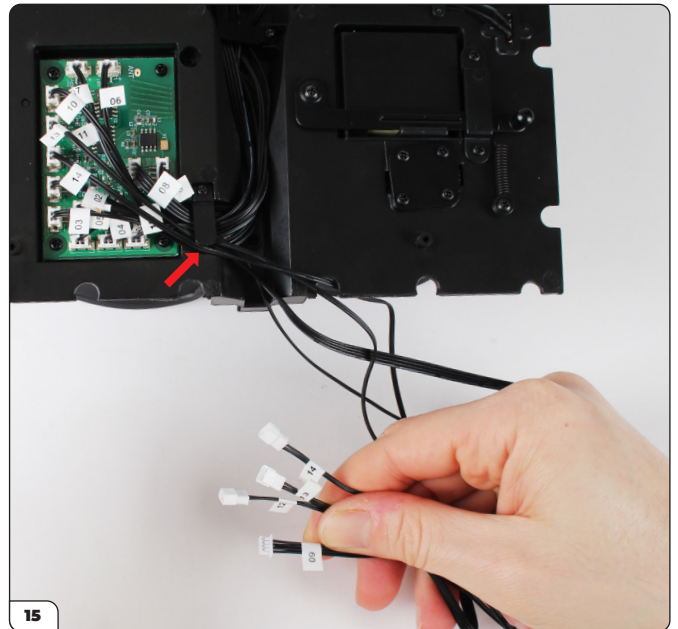

Tuck the wires under the bracket then gather them together along with wire '09'.

## Stage 057: Fitting the Steering Wheel and Dashboard LEDs

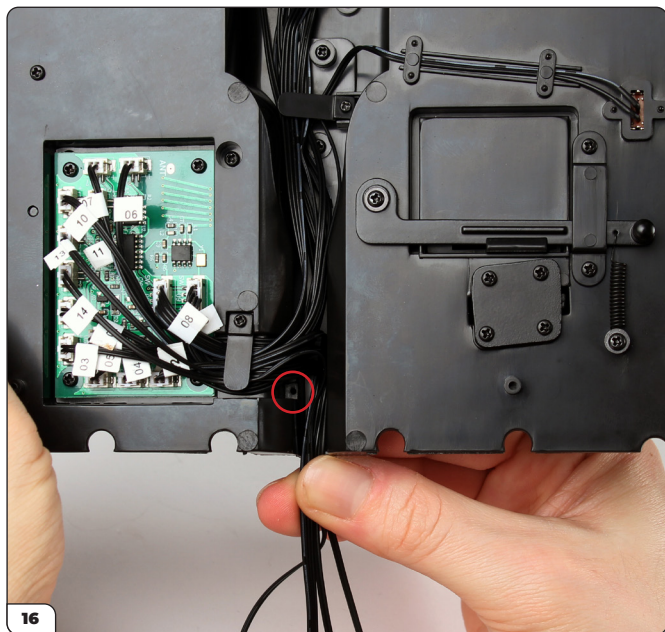

Push the wires into the tunnel and past the screw hole for the wire bracket (circled).

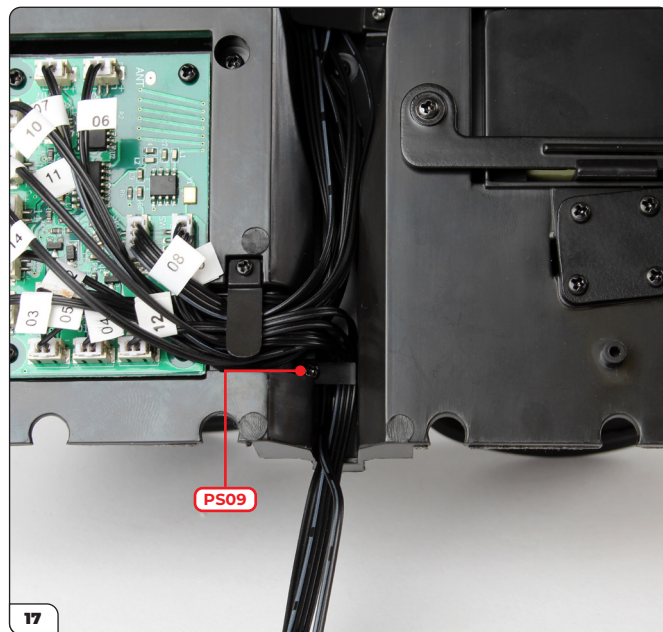

Fit the wire bracket (57-F) and secure with a PS09 screw to hold the wires in place.

