

**NO
TIME
TO
DIE** *007™*

DB5



Pack 09

BUILD INSTRUCTIONS

STAGE 067: BUILDING THE RADIATOR

STAGE 068: FITTING THE RADIATOR

**STAGE 069: ATTACHING THE
LEFT DOOR HANDLE**

**STAGE 070: FITTING THE LEFT DOOR
WINDOW AND HINGE**

**STAGE 071: BUILDING THE
LEFT DOOR PANEL**

**STAGE 072: MOUNTING THE
LEFT DOOR PANEL AND TRIM**

**STAGE 073: FITTING THE RADIO ANTENNA
AND DB5 BADGES**

STAGE 074: FITTING THE FUEL FILLERS

**STAGE 075: ATTACHING THE REAR
WINDOW AND SIDE MIRRORS**

NO TIME TO DIE © Danjaq, LLC and Metro-Goldwyn-Mayer Studios Inc. NO TIME TO DIE, *007™* and related James Bond Indicia © 1962-2024 Danjaq, LLC and Metro-Goldwyn-Mayer Studios Inc. NO TIME TO DIE, *007™* and related James Bond Trademarks are trademarks of Danjaq, LLC. All Rights Reserved.



Aston Martin, the Aston Martin Wings logo and the model name "DB5" are trademarks owned, licensed or used by Aston Martin Lagonda Limited. All Rights Reserved.

Advice from the experts

Spare screws are included with each part. Occasionally, you may be instructed to keep spare or unused screws for a later stage. Keep these spares in a safe place and label them correctly.

Please make sure you don't mix up the screws. They look quite similar, but the threads do vary slightly. Using the wrong screws may damage the parts.

When securing parts together using multiple screws, fit each screw loosely to ensure all the parts are correctly aligned before gently tightening them firmly, but not overtight, in the order in which you placed them.

The screwdriver can be magnetized by stroking it with a magnet (fridge magnet, etc.) enabling it to hold the screws and make assembly easier.

If a screw is tight going into a metal part, do not force it as you may shear the head off. Remove it and put a tiny smear of Vaseline, soap or light oil on the thread. That will lubricate it and make it easier to drive home.

During the course of this build, you will receive many pieces that you will assemble immediately – following the instructions in the corresponding stage – and other pieces that you should store safely to one side, for use in future assembly stages.

Left and Right! When building your *No Time To Die* Aston Martin DB5, the left- or right-hand side refers to that side as if you are sitting in the car.



WARNING: Some parts are assembled using magnets. These magnets can cause serious injury if they are swallowed. Keep away from children. If you suspect a magnet has been swallowed, seek medical help straight away.

Stage 067: Building the Radiator

In this stage you'll start to build the radiator by fitting the fan cowl.



STAGE 067 PARTS LIST

Name
67-A Radiator back
67-B Fan cowl
PS05 screws x5



67-A



67-B



PS05 x5

Stage 067: Building the Radiator



Align the fan cowl (67-B) with the radiator back (67-A). Note the pin and hole to help align the parts correctly (circled).



Fit the parts together.

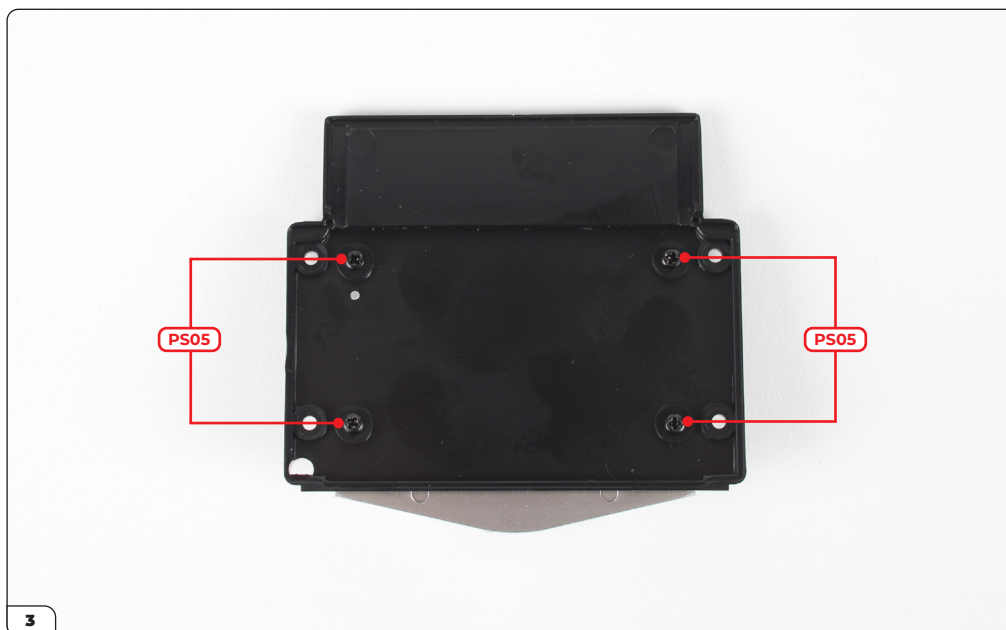

Secure with 4x PS05 screws.

Stage 067: Building the Radiator

STAGE COMPLETE

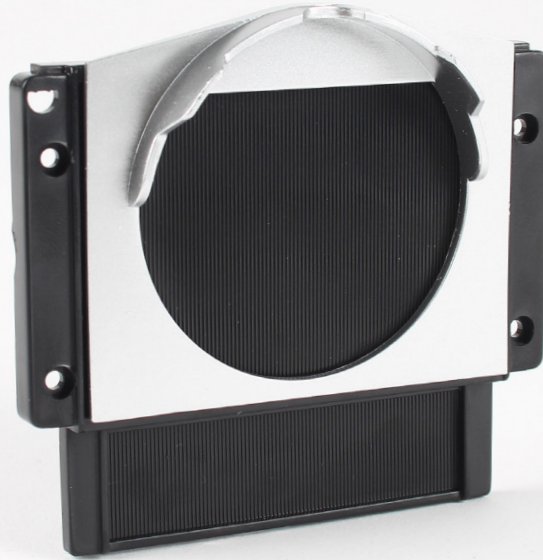

Stage 068: Fitting the Radiator

You'll continue to build the radiator by fitting the front, then fix it to the model and connect the pipe and hose.



STAGE 068 PARTS LIST

Name
68-A Radiator front
68-B Pipe
68-C Hose
DS02 screws x3
PS05 screws x5



Stage 068: Fitting the Radiator



1
Align the radiator front (68-A) with the radiator back (stage 067).



2
Fit the parts together.

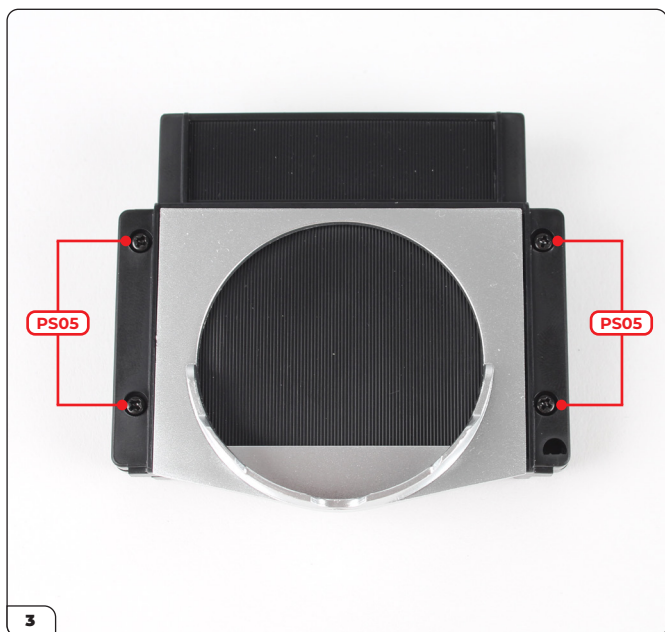

3
Secure with 4x PS05 screws.



4
Take the pipe and align it with the D-shaped hole.

Stage 068: Fitting the Radiator



Fit the pipe in place.

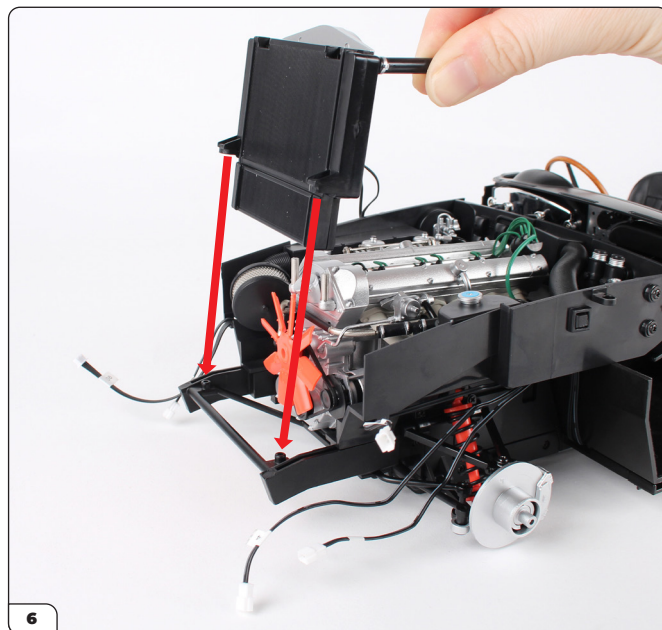

Align the radiator with the screw posts at the front of the chassis assembly (stage 066).

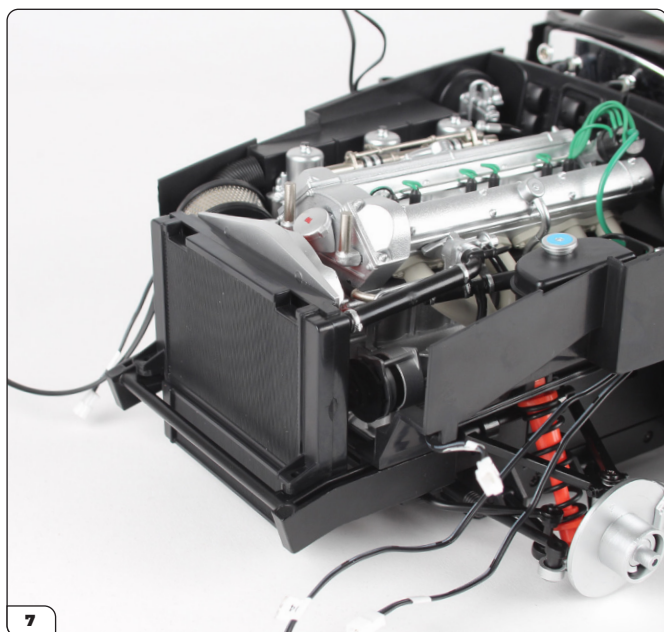

Fit the radiator in place. Take care to fit the fan into the fan cowl and fit the pipe into the cooling water thermostat (right image, circled)

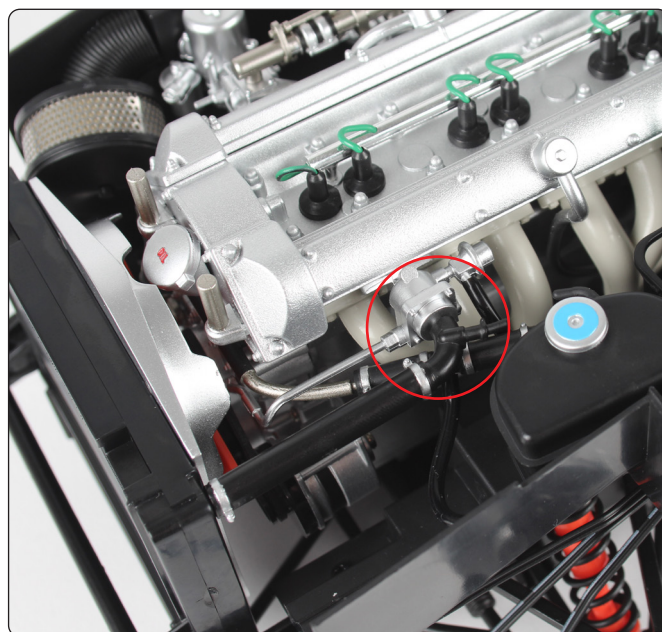

Stage 068: Fitting the Radiator

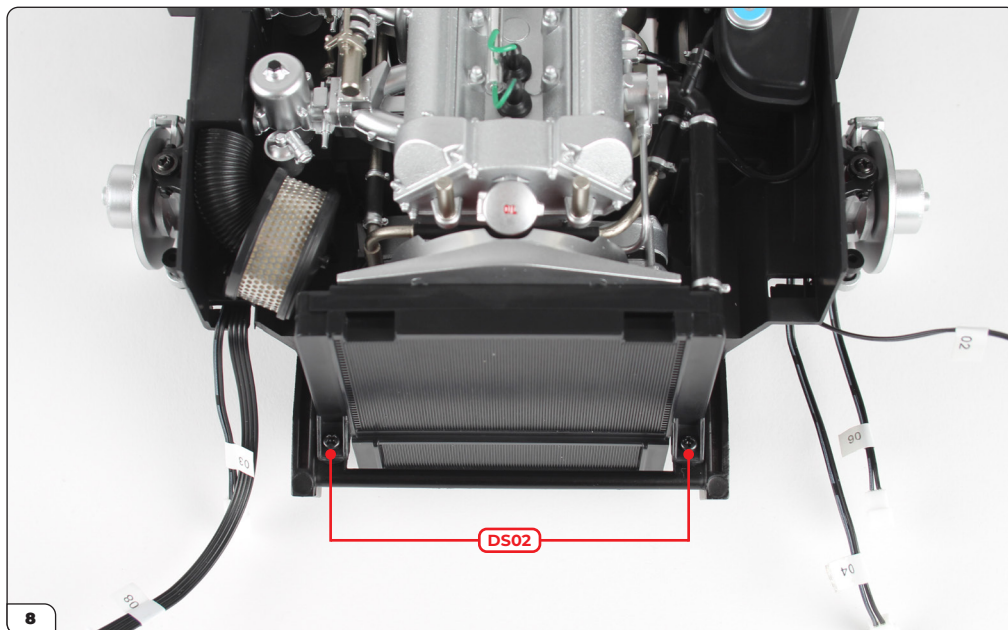

Secure the radiator with 2x DS02 screws.

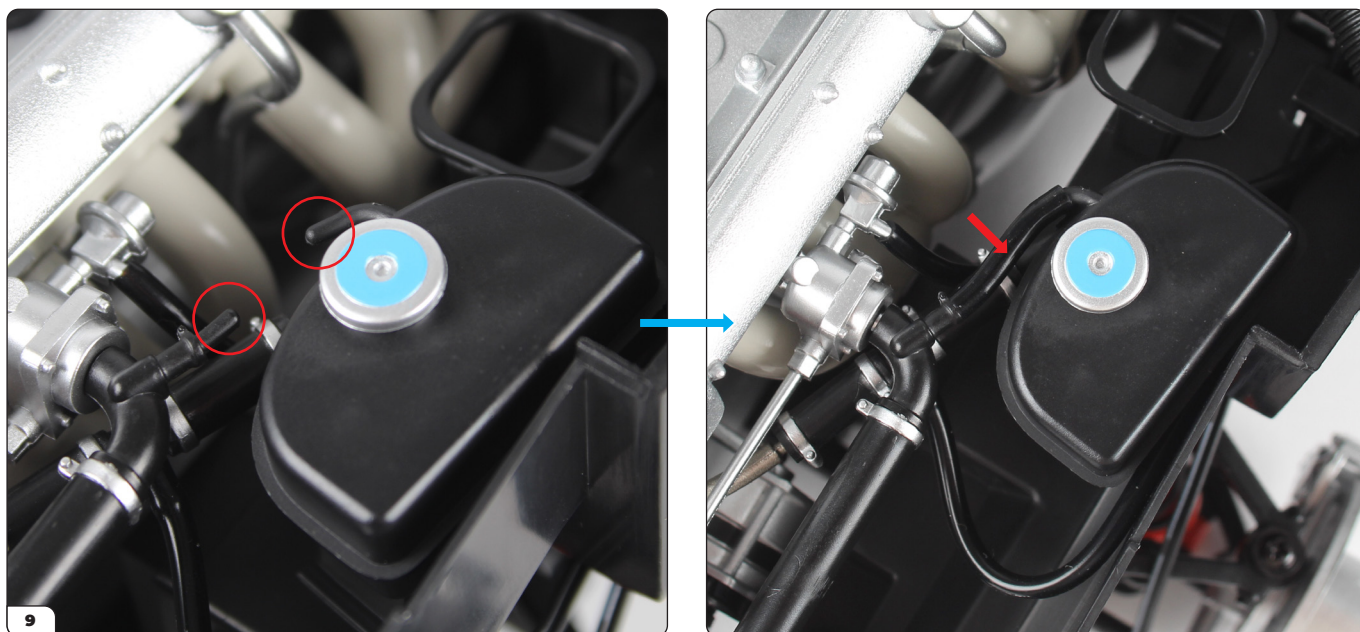

Push the hose (68-C) onto the pins on the header tank and the hose (circled).

Stage 068: Fitting the Radiator

STAGE COMPLETE

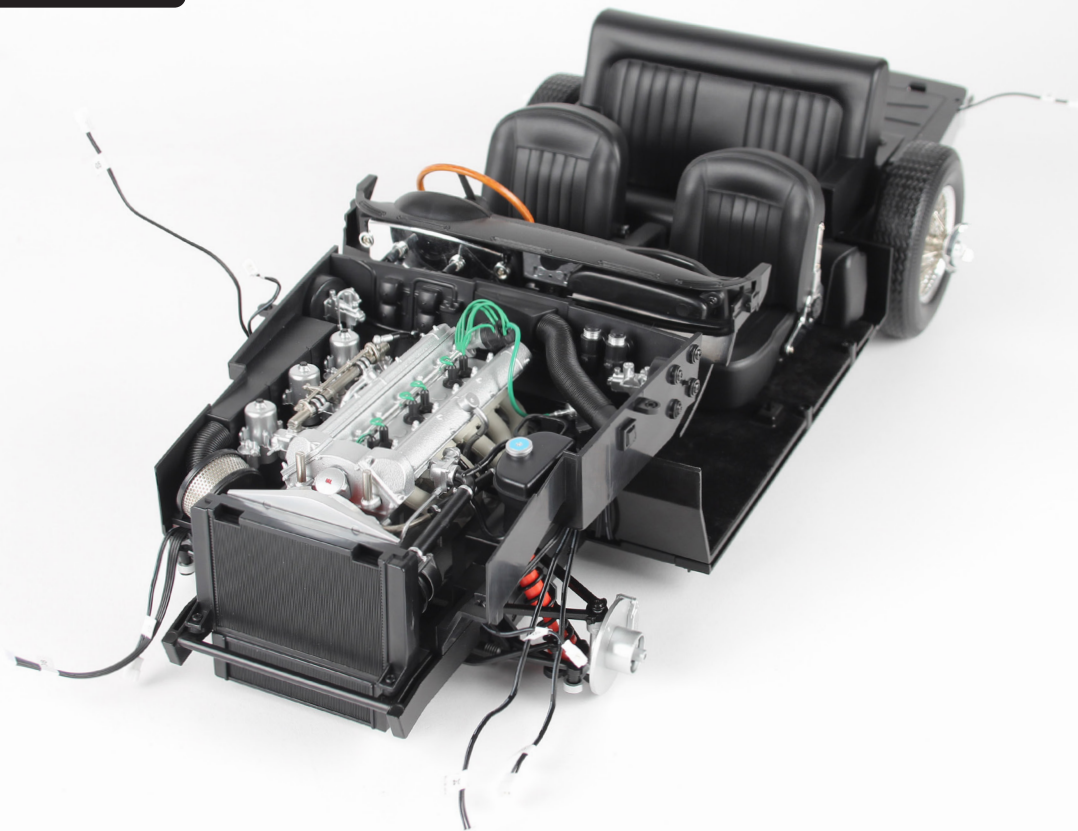

Stage 069: Attaching the Left Door Handle

In this stage you'll start to build the left door by attaching the handle.



STAGE 069 PARTS LIST

Name
69-A Left door
69-B Left door handle
PS21 screws x2



Stage 069: Attaching the Left Door Handle

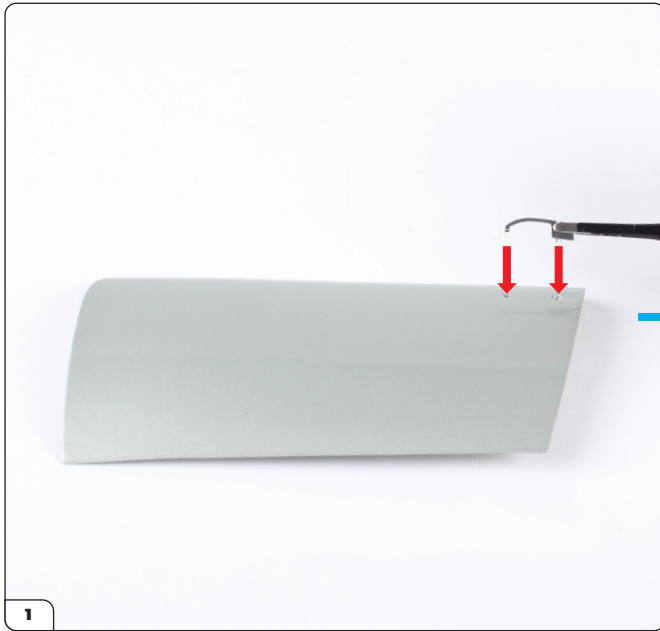

Take the left door handle (69-B) and fit it into the holes in the left door (69-A) as shown.

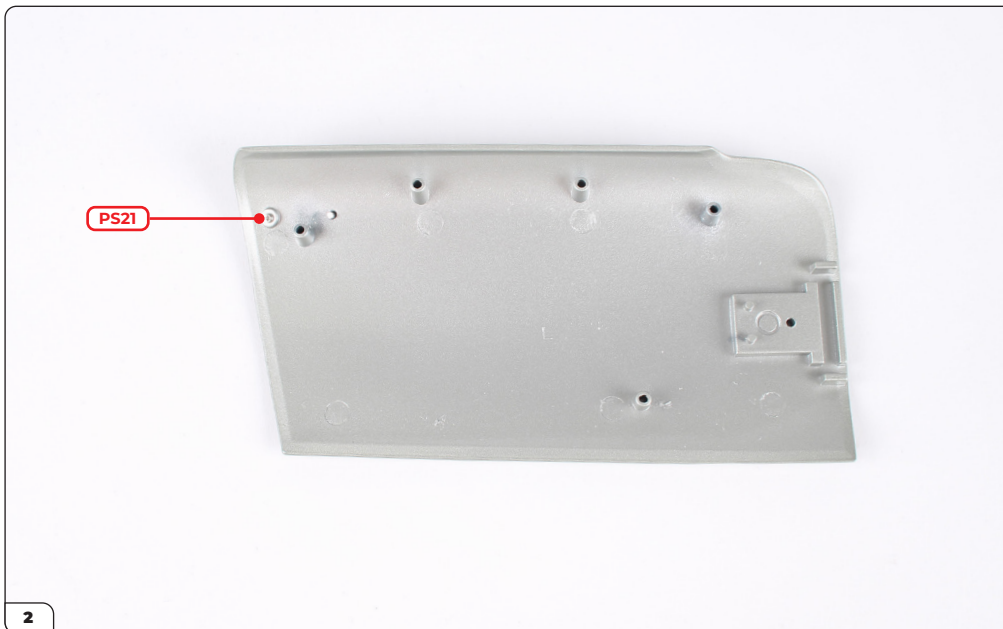

Secure with a PS21 screw.

Stage 069: Attaching the Left Door Handle

STAGE COMPLETE



Stage 070: Fitting the Left Door Window and Hinge

You'll continue building the left door by fitting the window and hinge.



STAGE 070 PARTS LIST

Name
70-A Left window
70-B Door hinge plate
70-C Door hinge mount
70-D Left window (with bullet impacts)
70-E Right window (with bullet impacts)
DS02 screws x4



Stage 070: Fitting the Left Door Window and Hinge

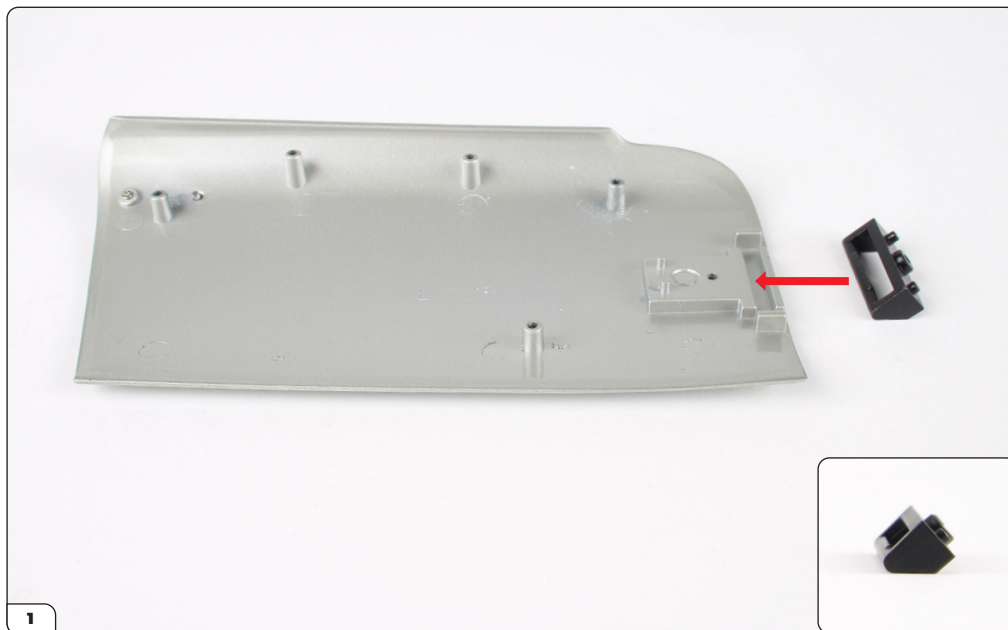

FITTING THE DOOR HINGE AND LEFT WINDOW

Take the left door (70-A) and align the door hinge mount (70-C) with it.

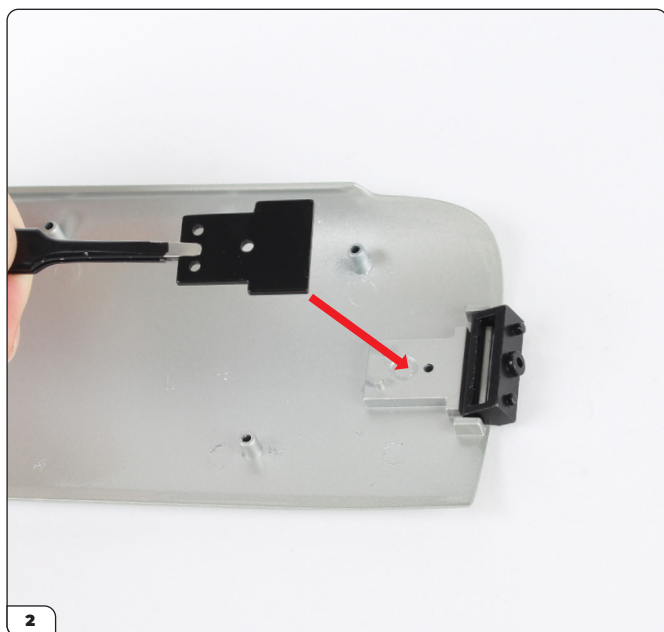

Fit the mount into the recess then align the door hinge plate (70-B) as shown.



Fit the plate in place and secure using a DS02 screw. Make sure the screw is fully tightened.

Stage 070: Fitting the Left Door Window and Hinge



You have two options for the glass on your model: the regular window (70-A) or the version with bullet impacts (70-D). Choose which version you prefer to use for the next steps.

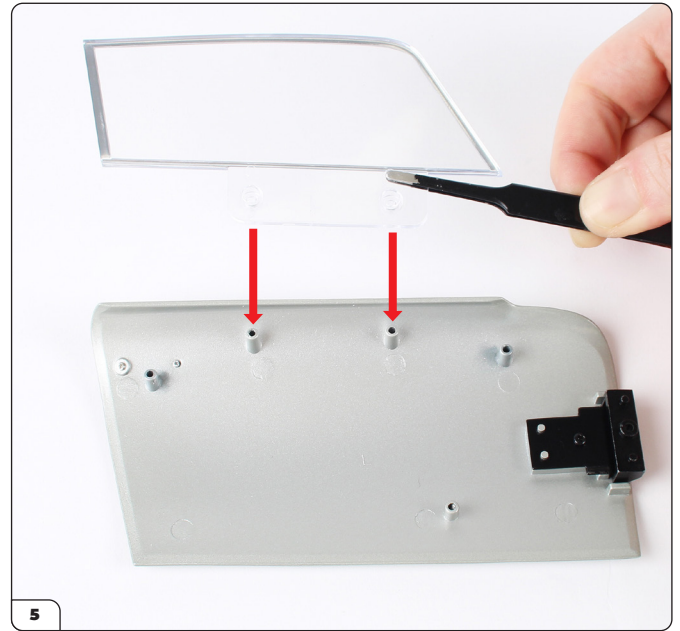

Align the window with the left door.

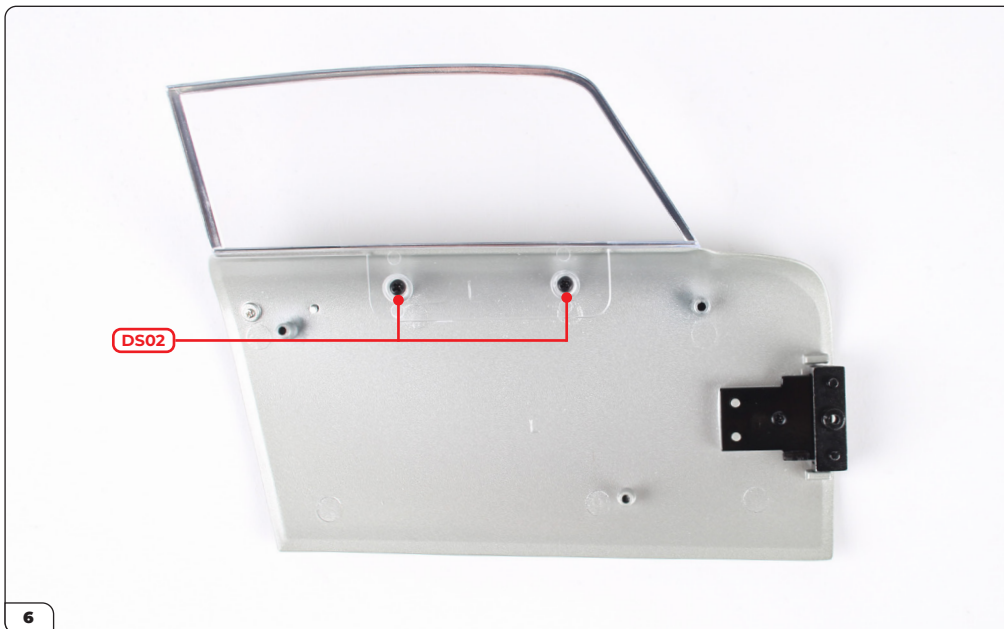

Secure with 2x DS02 screws. If you chose the regular windows for your model you can carry on to Stage 071. If you chose to use the bullet impact windows, the next steps will show you how to replace the original right window.

Stage 070: Fitting the Left Door Window and Hinge



FITTING THE RIGHT WINDOW WITH BULLET IMPACTS

To replace the regular window on the right door, take the right door from stage 007 and place it on the work surface. You will also need flat nose tweezers to help remove the trim. We recommend tools like these for this process, they are called “spudgers” or “plastic pry tools”.



Carefully remove the bottom trim.

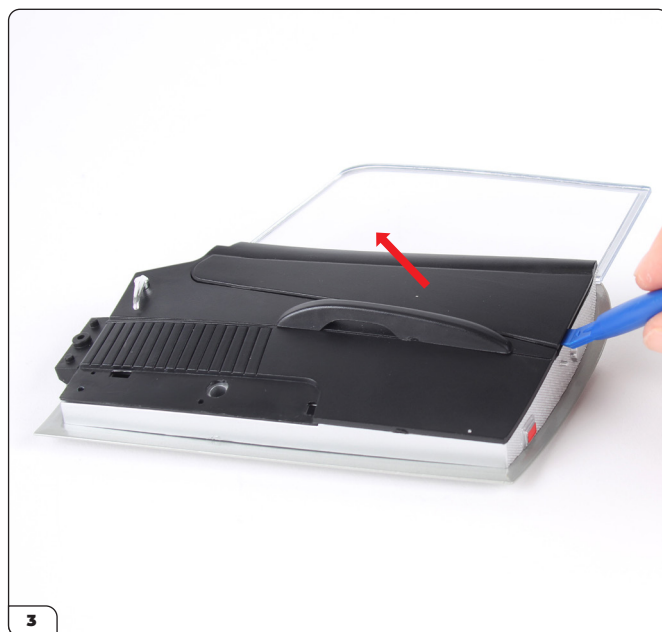

Remove the top trim.

Stage 070: Fitting the Left Door Window and Hinge



Remove the three DS02 screws and set them aside.



Remove the inner door panel.

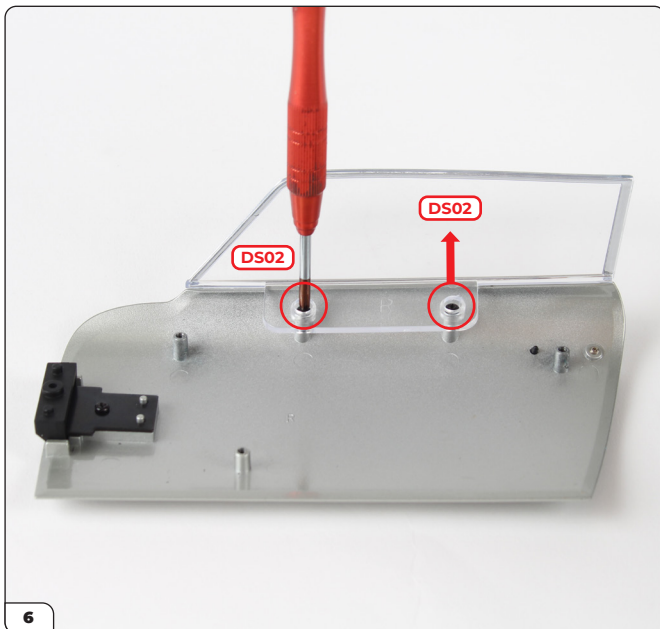

Remove the two DS02 screws then remove the right window.

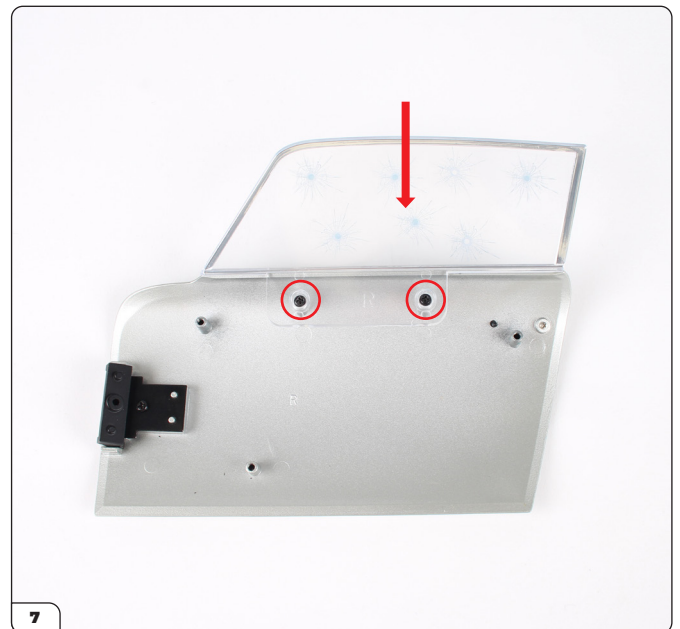

Replace with the right window with bullet impacts (70-E) and secure using the 2x DS02 screw removed in step 6.

Stage 070: Fitting the Left Door Window and Hinge



Fit the inner panel back in place and secure with 3x DS02 screws removed in step 4.



Fit the top and lower trim back in place.



Stage 071: Building the Left Door Panel

Next you'll build the left door panel ready to fit it in the next stage.



STAGE 071 PARTS LIST

Name
71-A Left door panel
71-B Left door armrest
71-C Left door handle
PS05 screws x3
PS12 screws x2



Stage 071: Building the Left Door Panel

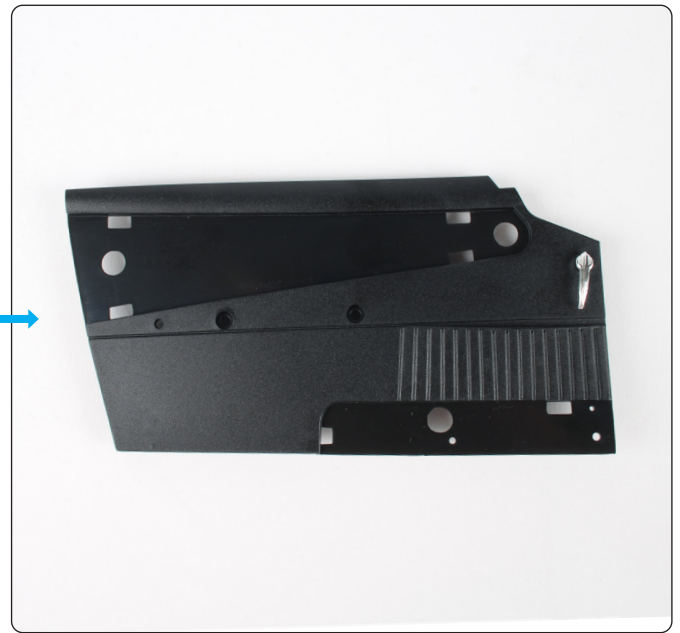
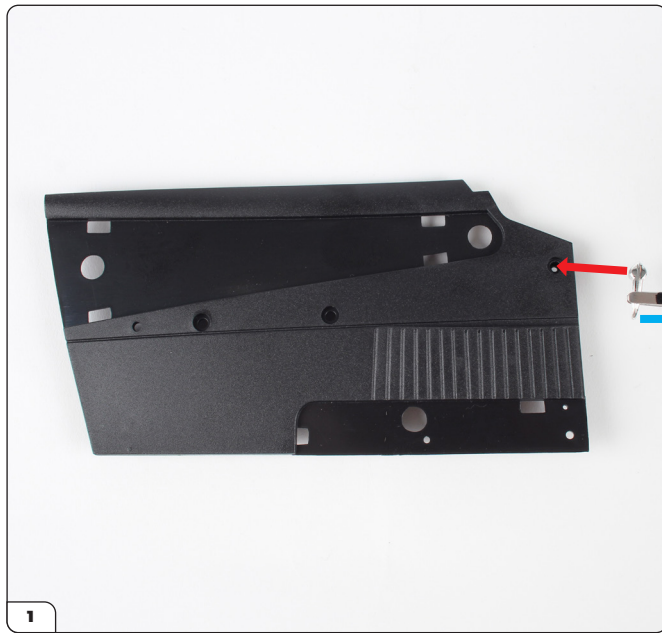

Take the left door handle (71-C) and fit it into the left door panel (71-A). The fitting is shaped to ensure the correct orientation.



Secure from the other side with a PS12 screw.

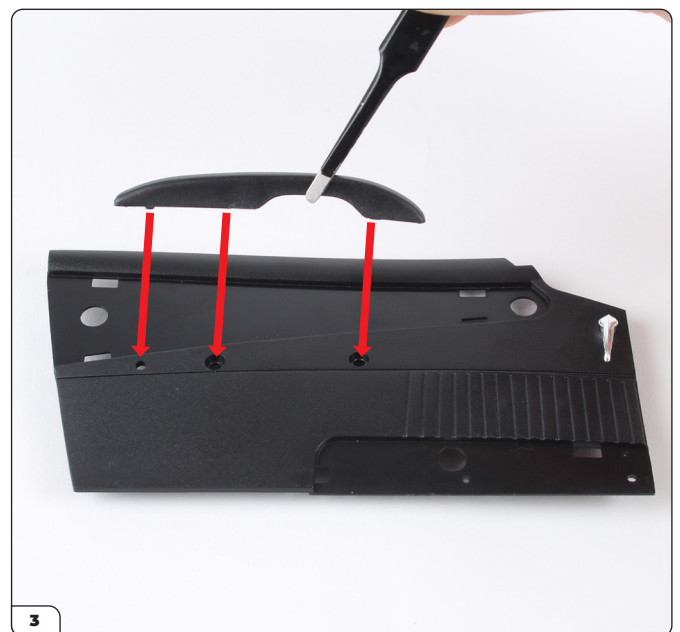

Align the left door armrest (71-B) with the panel.

Stage 071: Building the Left Door Panel



Fit the armrest in place.

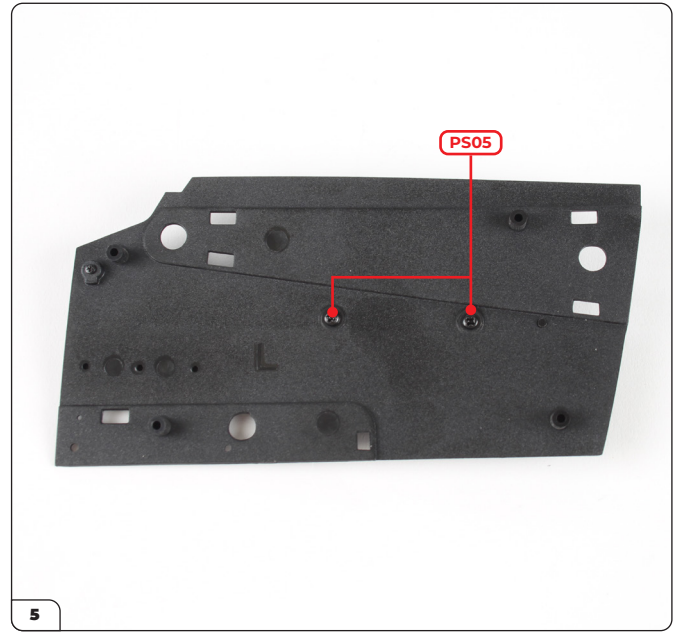

Secure from the other side with 2x PS05 screws.

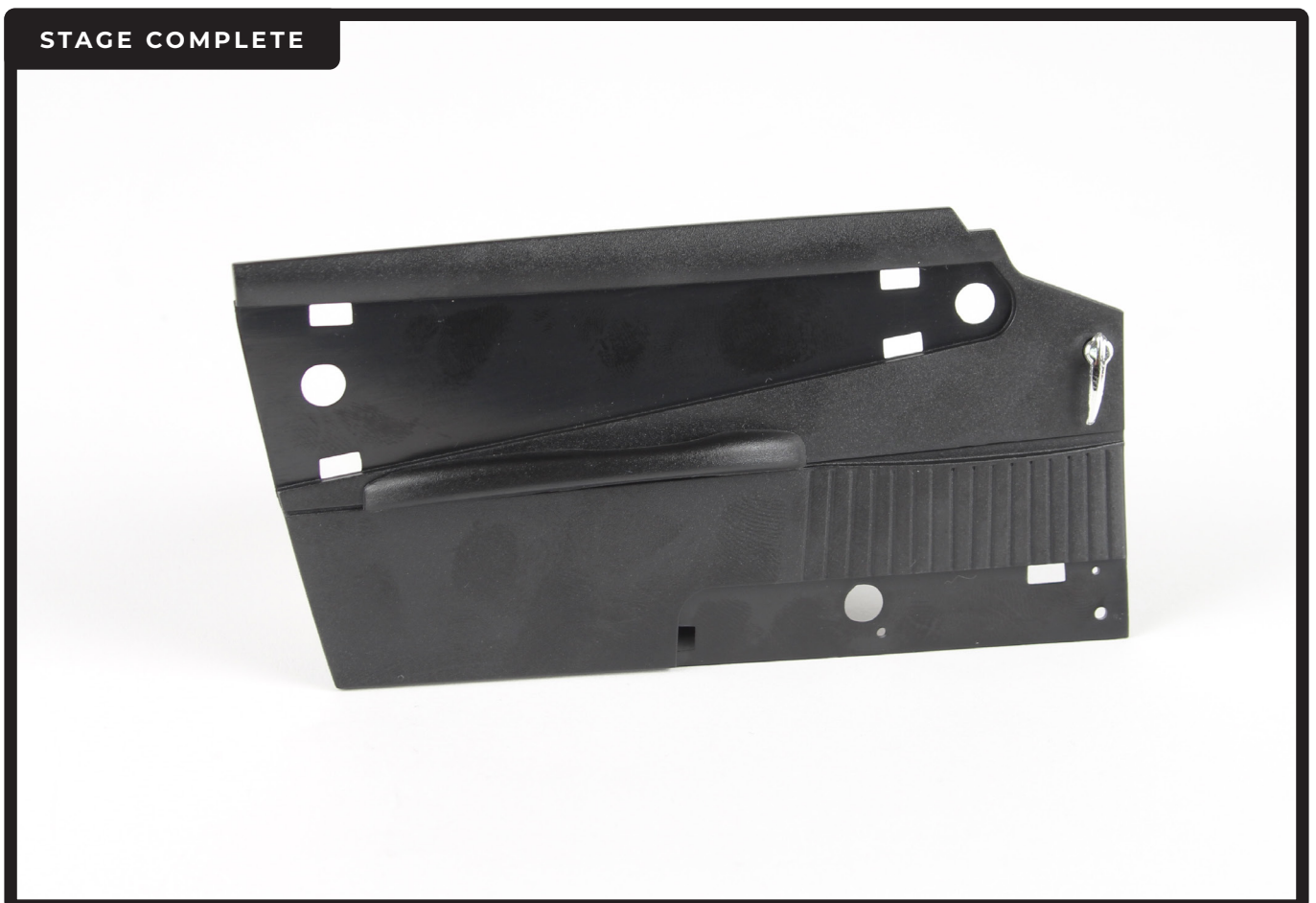

Stage 072: Mounting the Left Door Panel and Trim

You'll now finish building the left door by mounting the panel and trim.



STAGE 072 PARTS LIST

Name
72-A Left door inside panel
72-B Left door top trim
72-C Left door bottom trim
72-D Left door L-shaped trim
DS02 screws x4
PS05 screws x5



Stage 072: Mounting the Left Door Panel and Trim

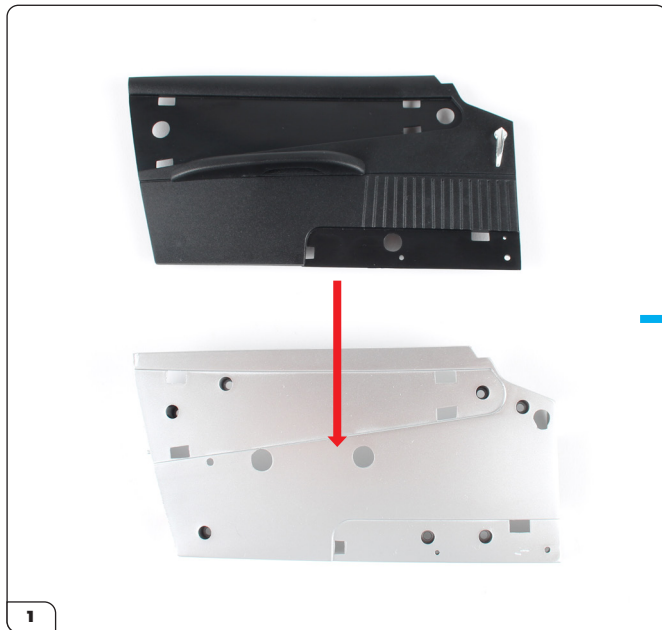

Align the left door panel (stage 071) with the inside panel (72-A) then fit the parts together.

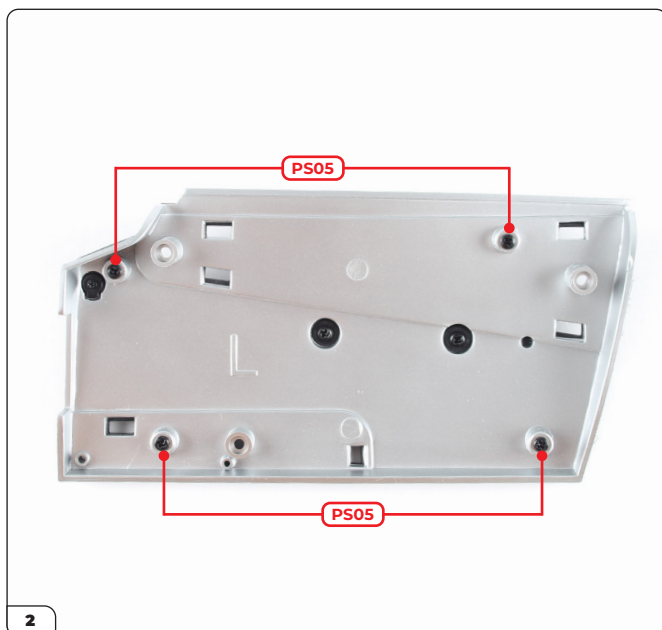

Secure from underneath with 4x PS05 screws.

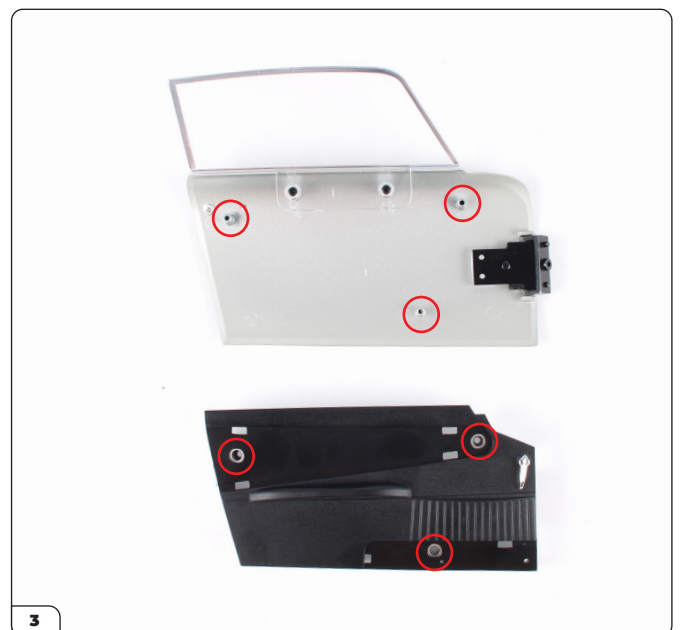

Align the inside panel with the left door assembly (stage 070).

Stage 072: Mounting the Left Door Panel and Trim

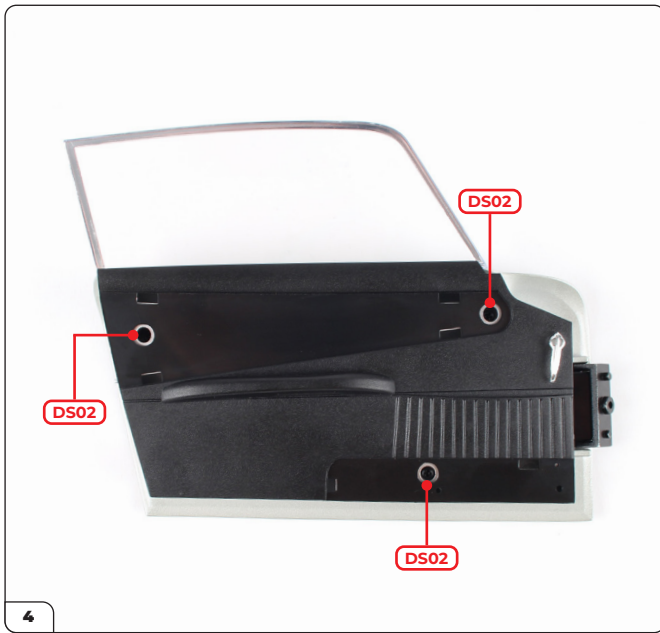

Fit in place and secure with 3x DS02 screws.

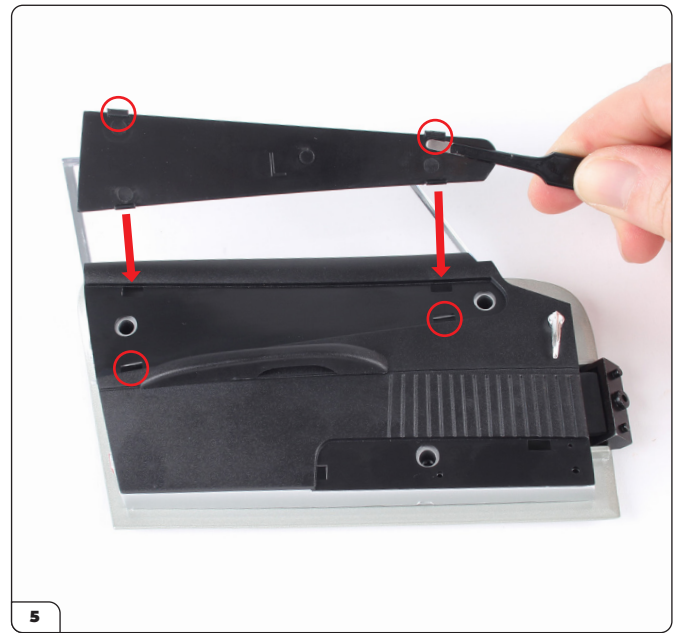

Fit the top trim (72-B) into the door panel, starting with the two tabs in the lower openings (circled), then push down firmly on the other tabs (arrows).

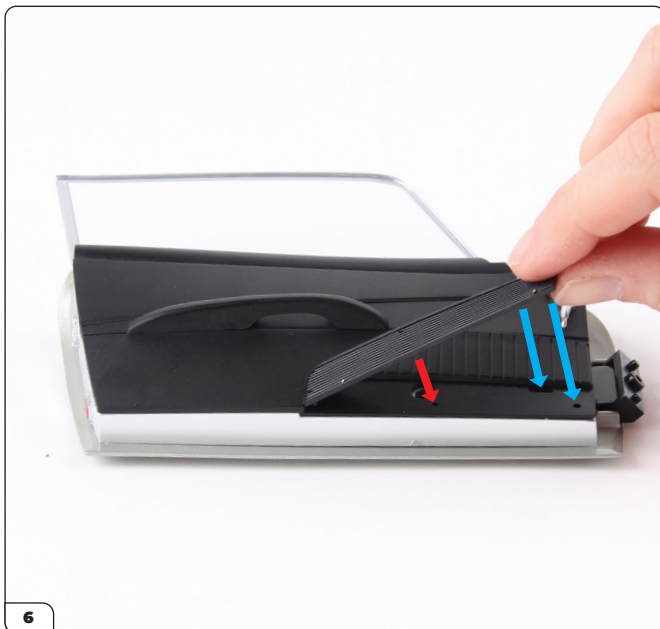

Fit the bottom trim (72-C) by pushing the left tab in as shown, then half-press the middle pin into its hole (red arrow). Press the remaining tab into its opening while pushing the other pin in place (blue arrows).



This image shows the top and bottom trims in place.

Stage 072: Mounting the Left Door Panel and Trim

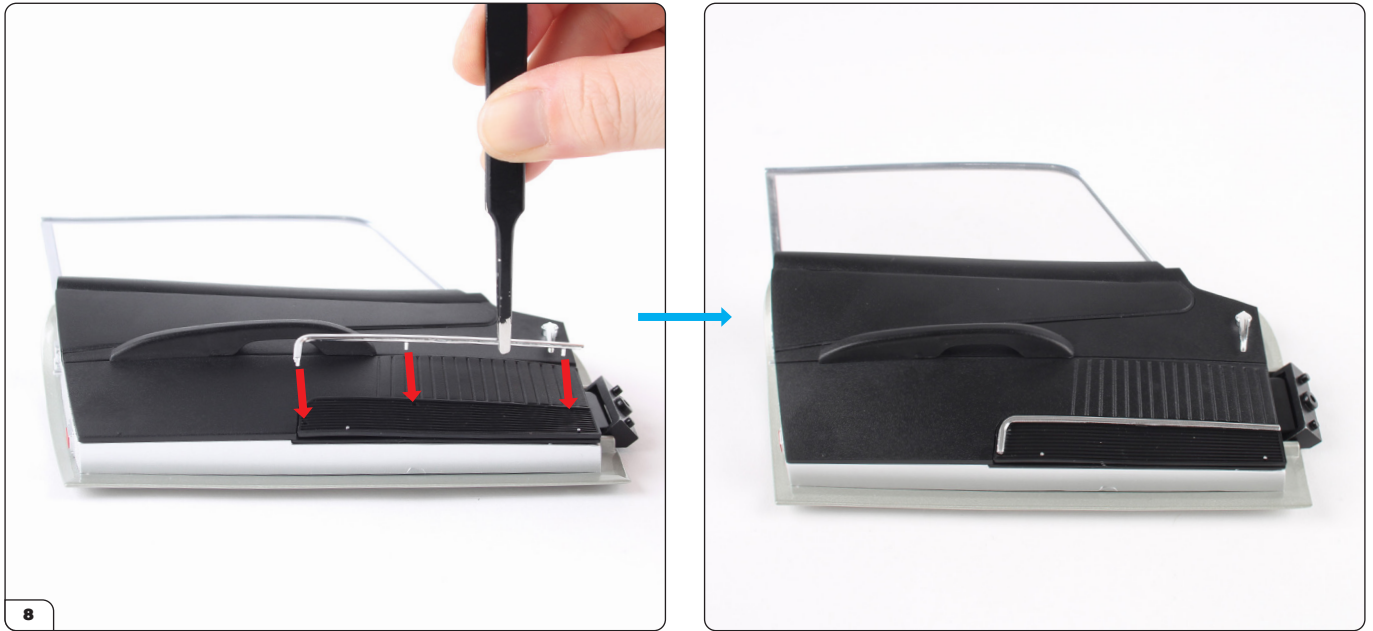

Align the L-shaped trim (72-D) with the three holes in the bottom trim then press into place.



Stage 073: Fitting the Radio Antenna and DB5 Badges

In this stage you'll start to work on the body by fitting the radio antenna and DB5 badges.



STAGE 073 PARTS LIST

Name
73-A Body
73-B DB5 badge
73-C DB5 badge
73-D Radio antenna
PS02 screws x2



Stage 073: Fitting the Radio Antenna and DB5 Badges

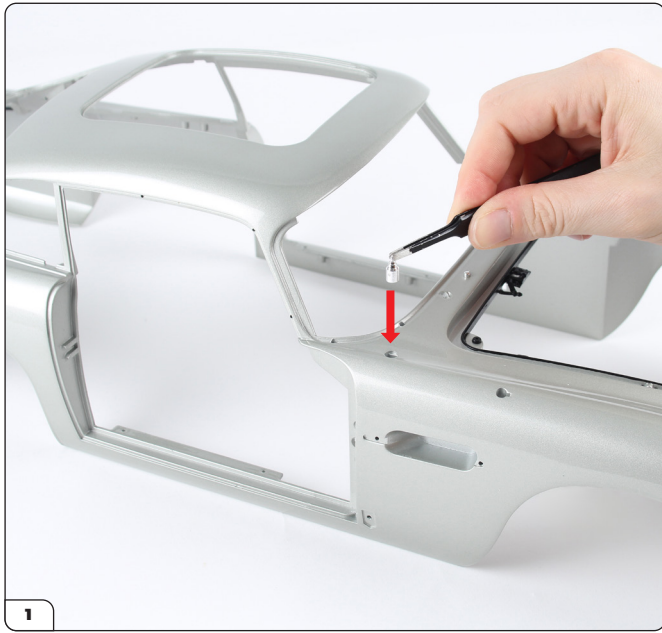

Take the radio antenna (73-D) and fit it into the hole in the body (73-A). The parts are shaped to ensure the correct fitting.

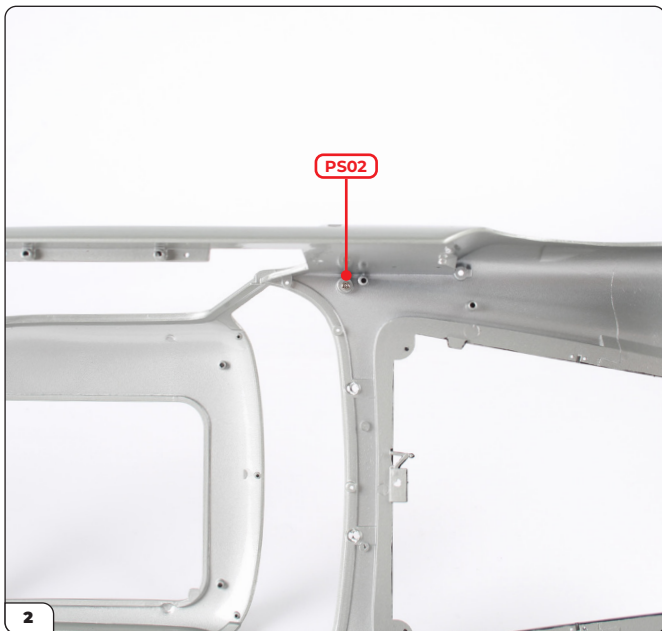

Secure from underneath with a PS02 screw.

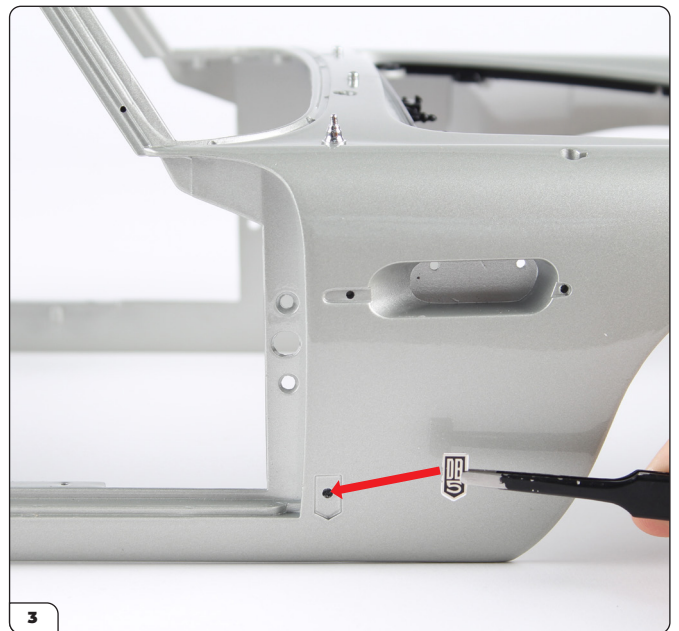

Take one of the badges (72-B or 72-C) and align it with the recess on the side of the body.

Stage 073: Fitting the Radio Antenna and DB5 Badges



Press the badge in place.



Press the remaining badge into the recess on the other side in the same way.

STAGE COMPLETE



Stage 074: Fitting the Fuel Fillers

You'll now continue to work on the body by building then fitting the fuel fillers.



STAGE 074 PARTS LIST

Name	Name
74-A Rear window	74-F Fuel filler cover (R)
74-B Rear window (with bullet impacts)	74-G Fuel filler cap x2
74-C Fuel filler housing (L)	PS01 screws x3
74-D Fuel filler cover (L)	DS33 screws x3
74-E Fuel filler housing (R)	



Stage 074: Fitting the Fuel Fillers



Take the fuel filler housings (74-C and 74-E) and covers (74-D and 74-F). Pair the left and the right together using the 'L' and 'R' markings (circled).



Take the left housing and cover then open the hinge on the housing as shown.



Detach one of the fuel filler caps (74-G) from the sprue and keep it to one side.

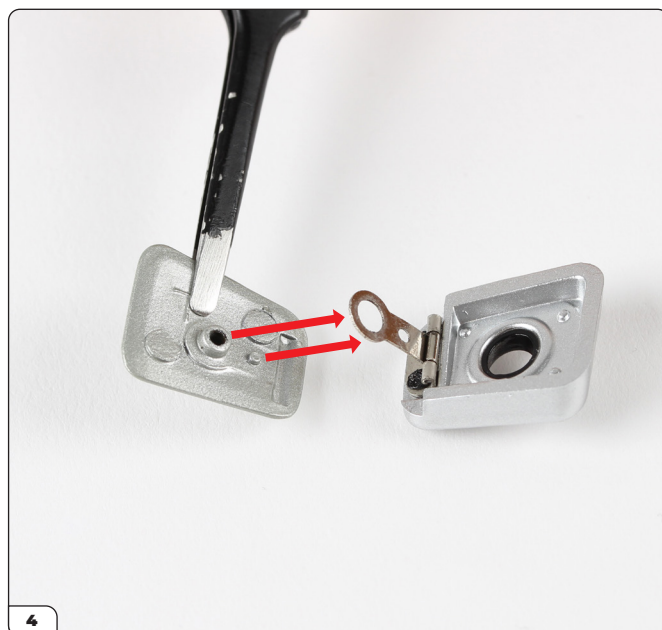

Fit the screw hole and pin on the cover into the hinge.

Stage 074: Fitting the Fuel Fillers



Place the fuel filler cap over the screw hole in the cover. Note one side of the cap is wider which fits face-down over the screw hole (inset).



Secure in place with a DS33 screw.



Repeat these steps with the right housing and cover, securing the parts together with another DS33 screw.



Align the right fuel filler with the recess on the right side of the body (stage 073).

Stage 074: Fitting the Fuel Fillers



Fit into place.



Secure from inside the body with a PS01 screw.



Fit the left fuel filler into the recess on the left side in the same way.

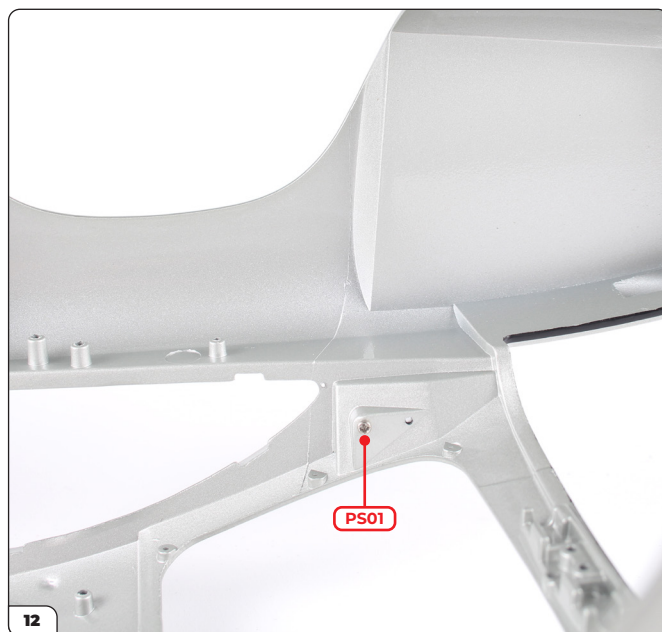

Secure with a PS01 screw.

Stage 074: Fitting the Fuel Fillers

STAGE COMPLETE



Stage 075: Attaching the Rear Window and Side Mirrors

In the last stage of this pack you'll fix the rear window in place then build and attach the side mirrors.



STAGE 075 PARTS LIST

Name
75-A Rear window frame
75-B Left side mirror
75-C Right side mirror
75-D Side mirror interior x2
75-E Side mirror reflector x2
PS01 screws x3
PS21 screws x8



Stage 075: Attaching the Rear Window and Side Mirrors



Choose either the regular rear window or the one with bullet impacts, which were both supplied in stage 074.



Align the rear window with the body (stage 074).

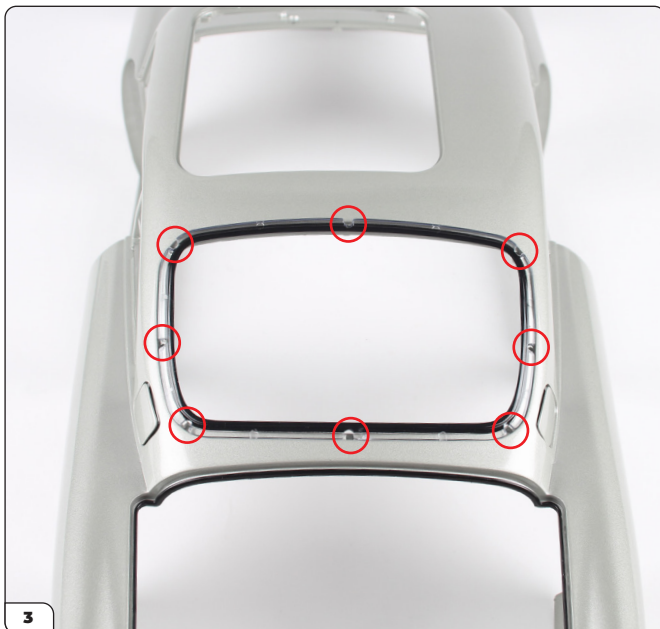

Fit the rear window in place. Check that the notches and screw holes are aligned (circled).



Align the rear window frame (75-A) with the screw holes.

Stage 075: Attaching the Rear Window and Side Mirrors



Press the frame firmly in place.

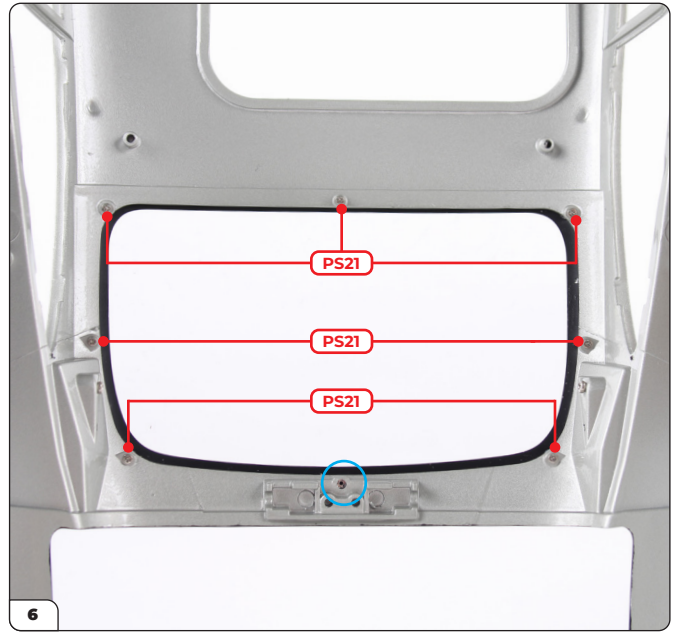

Secure from inside the body with 7x PS21 screws. Leave the hole closest to the boot unscrewed for now (blue circle).



Detach the side mirror interiors (75-D) from the sprue. Pair the left and the right interior with the left (75-B) and right (75-C) side mirrors using the 'L' and 'R' markings (circled).

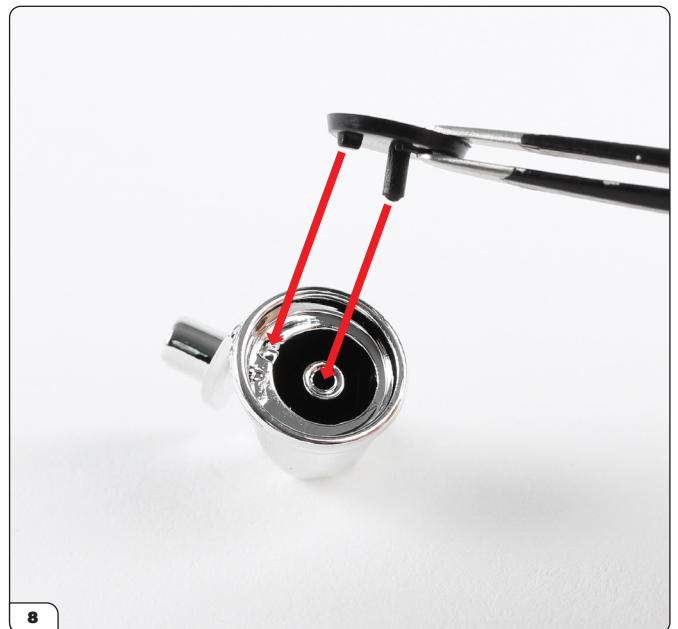

The interior has a tab and pin which aligns with the fitting in the side mirror.

Stage 075: Attaching the Rear Window and Side Mirrors

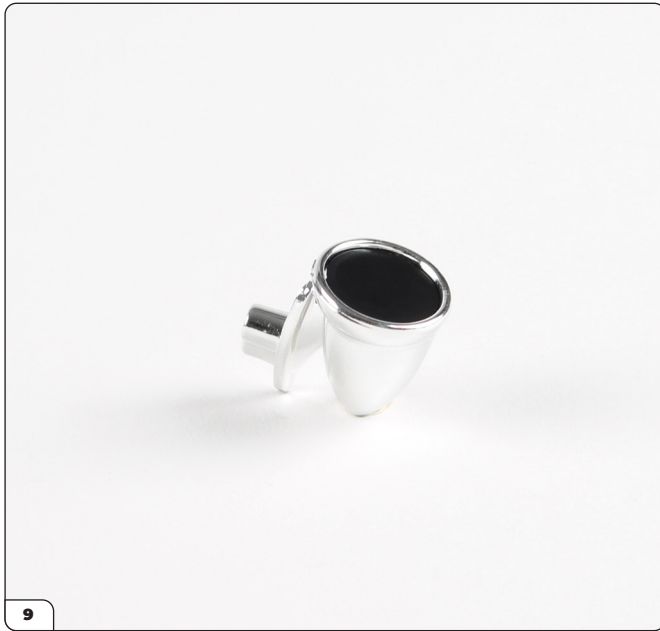

Fit the interior marked 'R' into the side mirror marked 'R'.

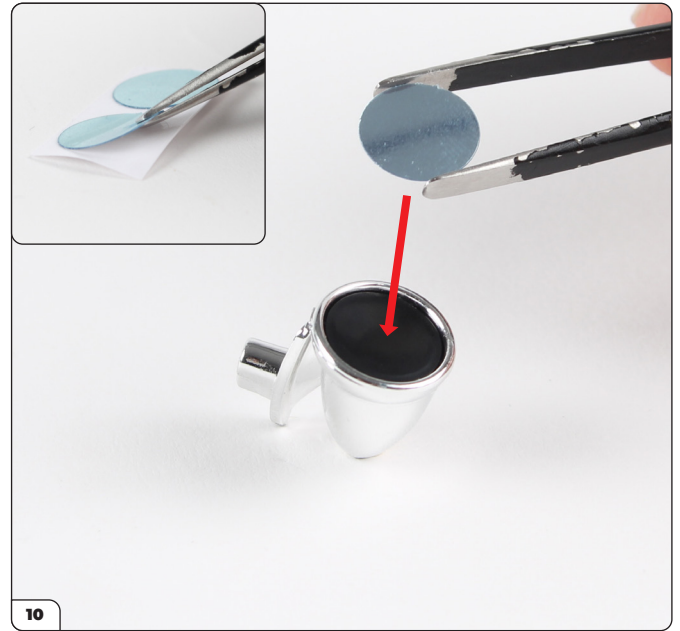

Peel one of the side mirror reflectors (75-E) from the backing paper and stick it onto the interior.



The right side mirror has been assembled.



Repeat steps 8-10 to assemble the left side mirror.

Stage 075: Attaching the Rear Window and Side Mirrors



The fittings on the side mirrors are different sizes. The left side mirror has a larger fitting.

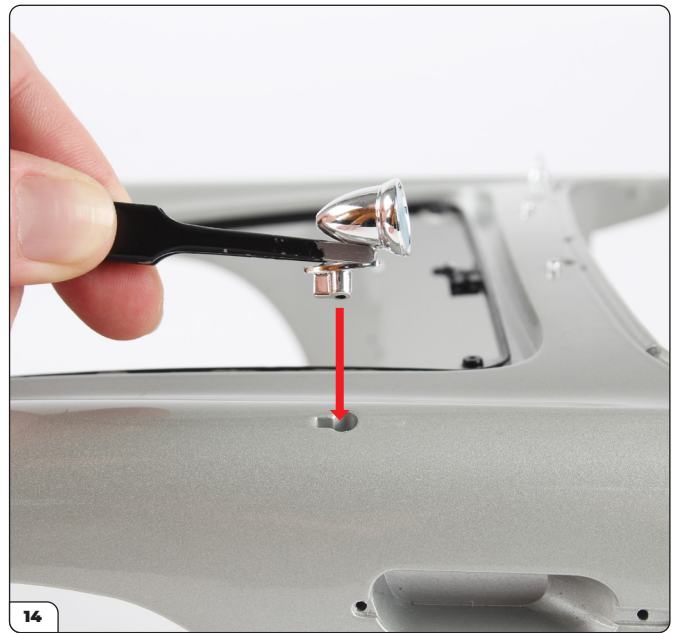

Fit the left side mirror into the corresponding hole on the left side of the body. The side mirrors are fragile, so you may prefer to fit them at the end of the assembly.



This image shows the left side mirror in place.



Secure from inside the body with a PS01 screw.

Stage 075: Attaching the Rear Window and Side Mirrors



Fit the right side mirror in place.



Secure with a PS01 screw.

STAGE COMPLETE

