

**THE
SPY WHO
LOVED
ME™**

LOTUS
esprit



Pack 05

BUILD INSTRUCTIONS

STAGE 035: FITTING THE ENGINE COVER

**STAGE 036: BUILDING THE
INSTRUMENT PANEL**

**STAGE 037: BUILDING THE
DASHBOARD AND RADAR**

STAGE 038: FITTING THE STEERING WHEEL

**STAGE 039: ASSEMBLING THE
CENTRE CONSOLE (I)**

**STAGE 040: ASSEMBLING THE
CENTRE CONSOLE (II)**

**STAGE 041: FITTING THE CENTRE CONSOLE
AND DASHBOARD TRIM**

**STAGE 042: ADDING CARPET TO THE
COCKPIT FLOOR**

THE SPY WHO LOVED ME © Danjaq, LLC and Metro-Goldwyn-Mayer Studios Inc. THE SPY WHO LOVED ME, *007*™ and related James Bond Indicia © 1962-2024 Danjaq, LLC and Metro-Goldwyn-Mayer Studios Inc. THE SPY WHO LOVED ME, *007*™ and related James Bond Trademarks are trademarks of Danjaq, LLC. All Rights Reserved. Produced under licence from Group Lotus LTD. LOTUS, the Lotus Roundel, car names and all associated logos and distinctive designs are trade marks of Group Lotus LTD.

Advice from the experts

Spare screws are included with each part. Occasionally, you may be instructed to keep spare or unused screws for a later stage. Keep these spares in a safe place and label them correctly.

Please make sure you don't mix up the screws. They look quite similar, but the threads do vary slightly. Using the wrong screws may damage the parts.

When securing parts together using multiple screws, fit each screw loosely to ensure all the parts are correctly aligned before gently tightening them firmly, but not overtight, in the order in which you placed them.

The screwdriver can be magnetized by stroking it with a magnet (fridge magnet, etc.) enabling it to hold the screws and make assembly easier.

If a screw is tight going into a metal part, do not force it as you may shear the head off. Remove it and put a tiny smear of Vaseline, soap or light oil on the thread. That will lubricate it and make it easier to drive home.

During the course of this build, you will receive many pieces that you will assemble immediately – following the instructions in the corresponding stage – and other pieces that you should store safely to one side, for use in future assembly stages.

Left and Right! When building your *The Spy Who Loved Me* Lotus Esprit, the left- or right-hand side refers to that side as if you are sitting in the car.



WARNING: Some parts are assembled using magnets. These magnets can cause serious injury if they are swallowed. Keep away from children. If you suspect a magnet has been swallowed, seek medical help straight away.

Stage 035: Fitting the Engine Cover

In this stage you'll fit the engine cover to the rear floor.

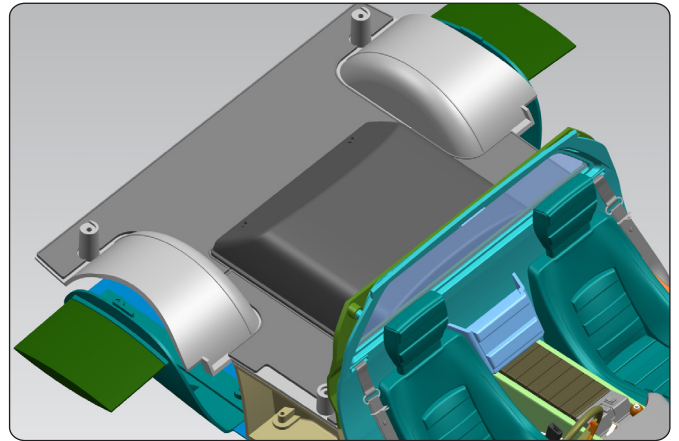

STAGE 035 PARTS LIST

Name
35-A Engine cover

35-A



Stage 035: Fitting the Engine Cover

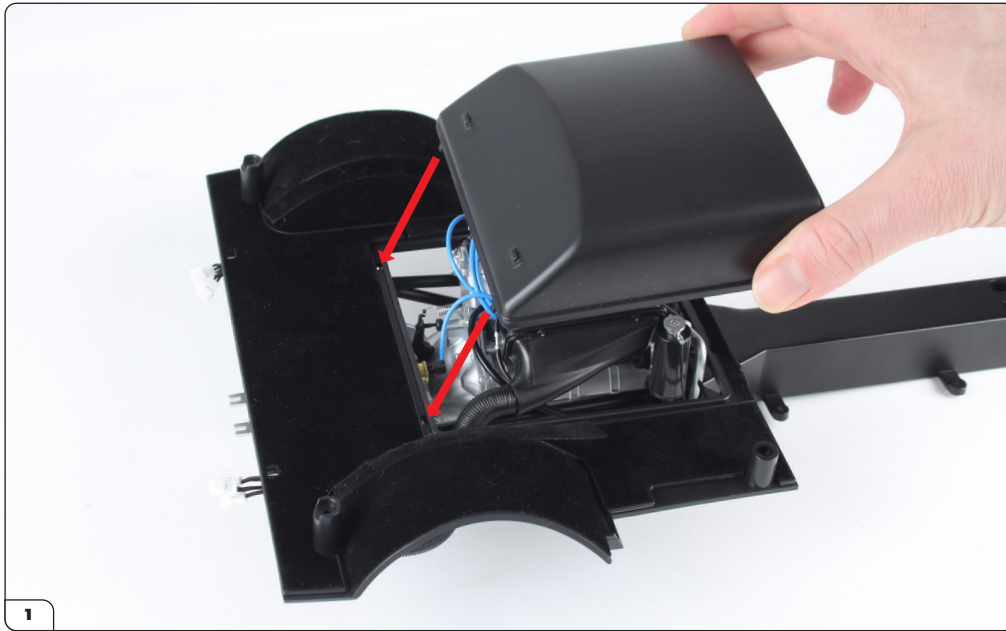

Align the engine cover (35-A) with the rear floor as shown. Push the two tabs into the corresponding holes.



Press the opposite side down.

Stage 035: Fitting the Engine Cover



The engine cover has been fitted.

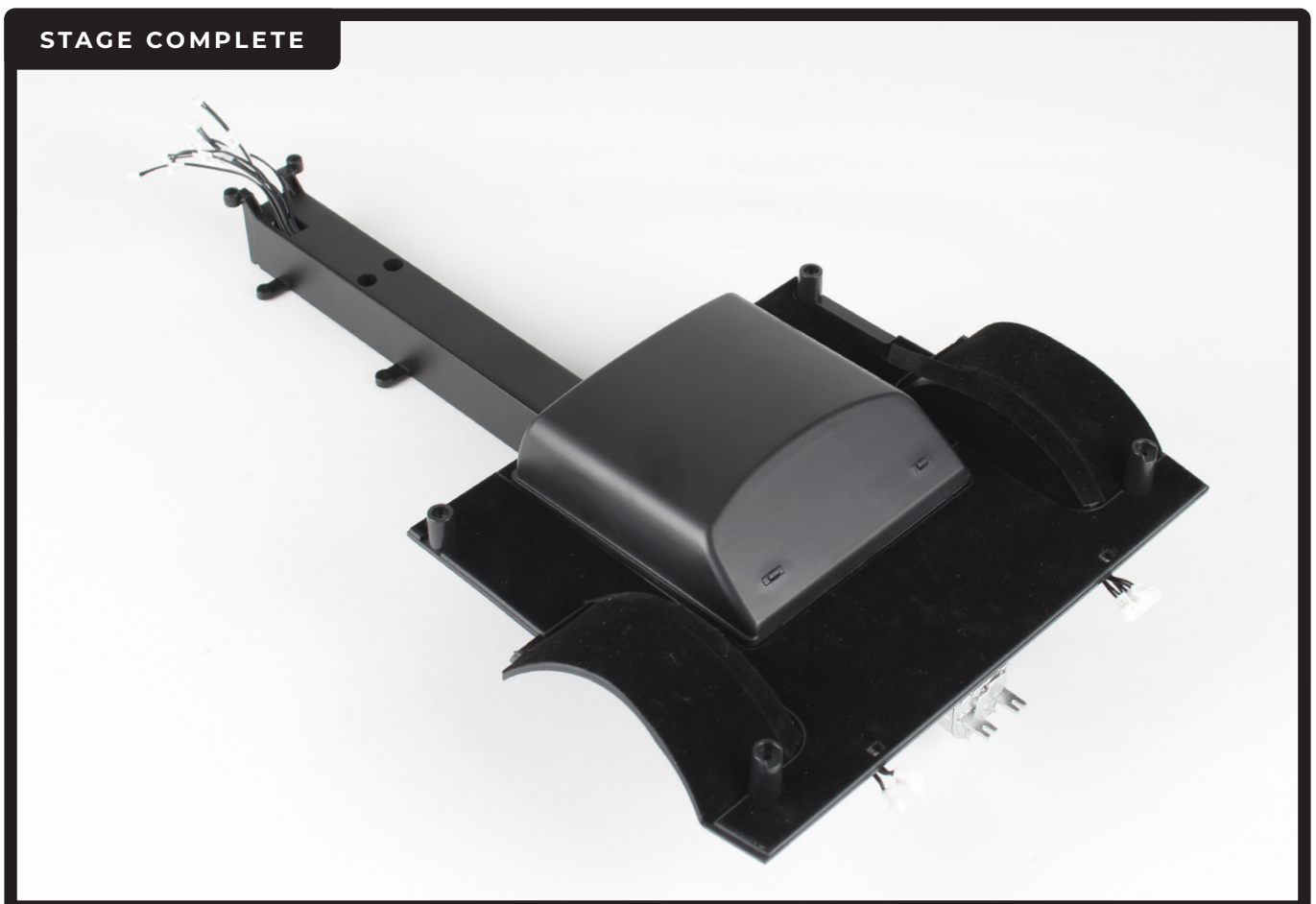

Stage 036: Building the Instrument Panel

In this stage you'll build the instrument panel, which features the nautical display.

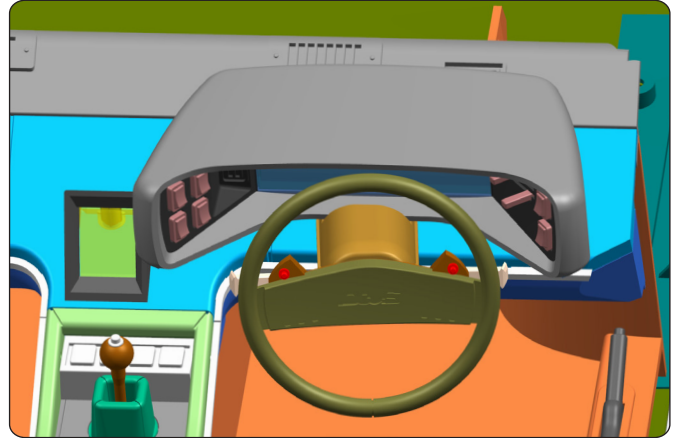

STAGE 036 PARTS LIST

Name	Name
36-A Instrument panel top	36-G Left buttons
36-B Instrument panel bottom	36-H Instrument LED cable No. 10
36-C Centre display	Nautical sticker sheet
36-D Right display	Reflector sticker sheet
36-E Left display	PS02 screws x5
36-F Right buttons	

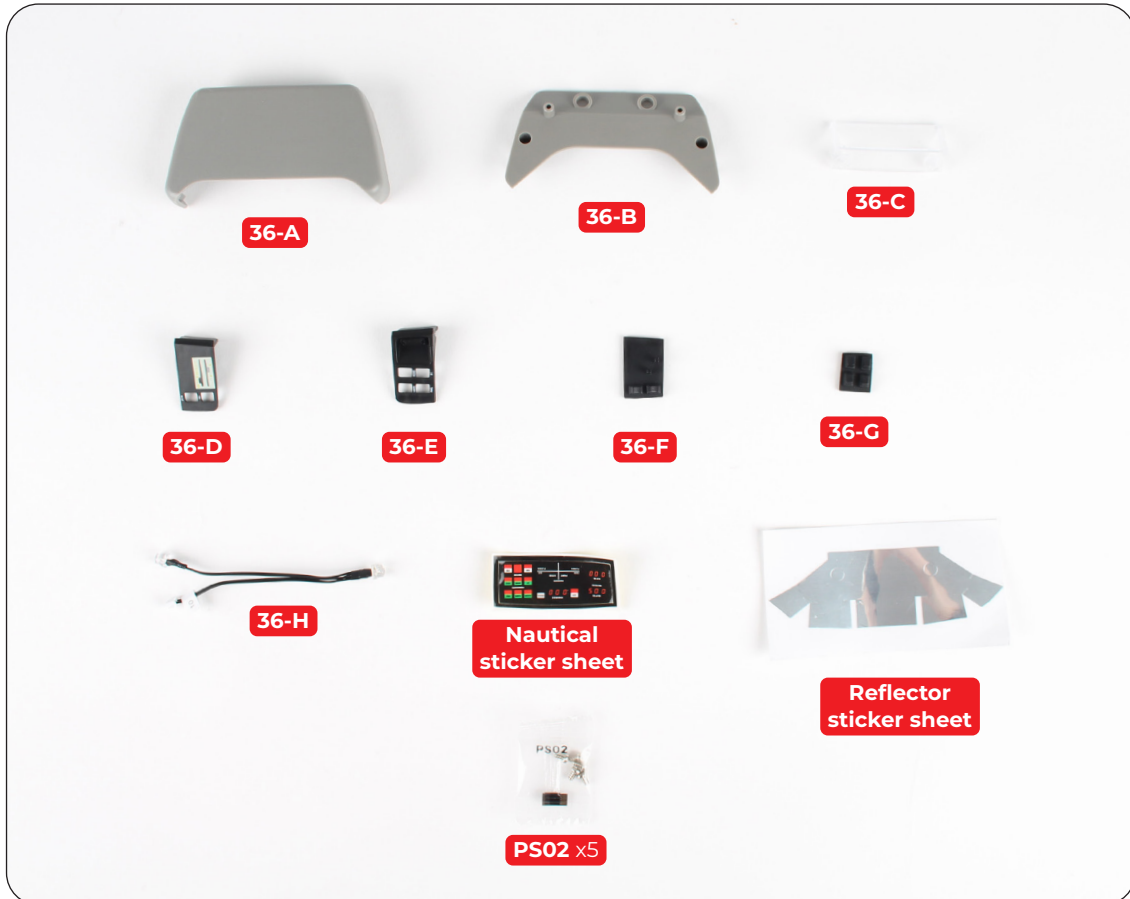

Stage 036: Building the Instrument Panel

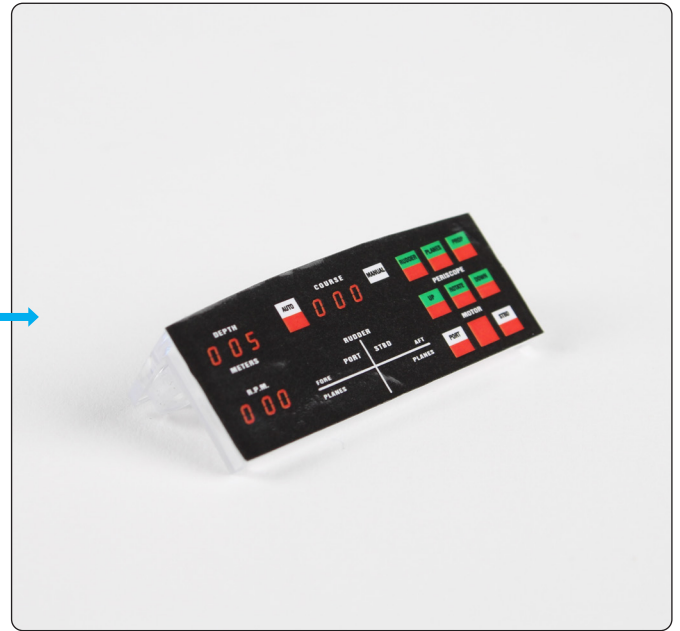

Take the nautical sticker sheet. Remove the sticker from the backing paper and press it onto the centre display (36-C) in the orientation shown.

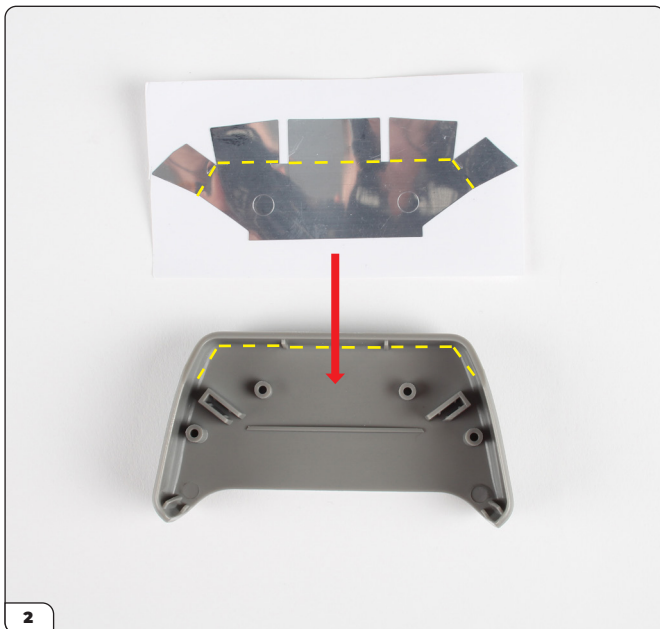

Take the reflector sticker sheet. Note the reflector sticker has tabs that fold to fit the instrument panel top (36-A) as shown by the dashed lines.

Remove the reflector sticker from the backing paper and press it firmly onto the instrument panel top.

Stage 036: Building the Instrument Panel



Once the reflector is in place, remove the protective film from the silver-coloured side as shown.



Place the centre display onto the screw posts.



Secure with 2x PS02 screws.



Press the right display (36-D) onto the right buttons (36-F).

Stage 036: Building the Instrument Panel



The right display should look like this.



Press the left display (36-E) onto the left buttons (36-G) using the pin as a guide.



The left display should look like this.



Push the right display into the instrument panel top.

Stage 036: Building the Instrument Panel



Push the left display in place.



The displays should look like this.

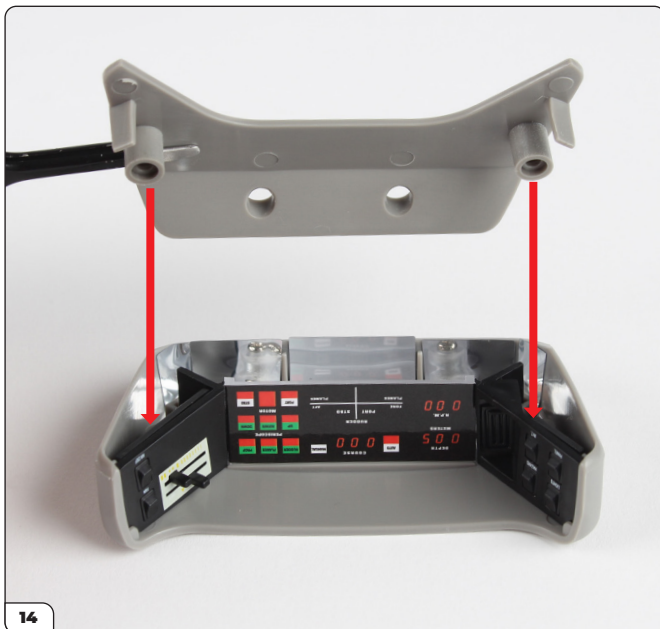

Press the instrument panel bottom (36-B) onto the top.



Secure with 2x PS02 screws.

Stage 036: Building the Instrument Panel

STAGE COMPLETE

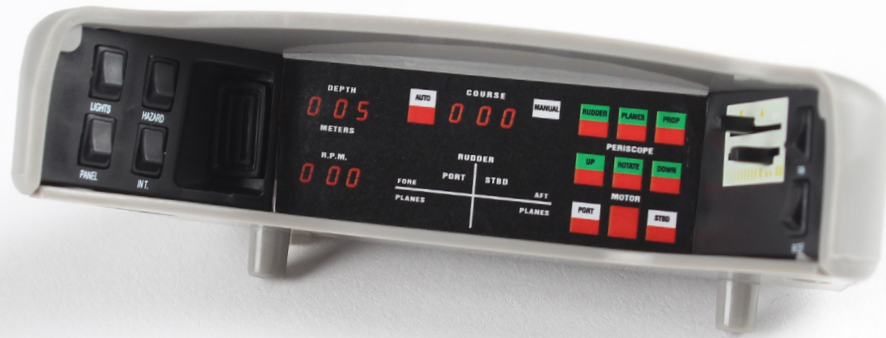

Stage 037: Building the Dashboard and Radar

In this stage you'll assemble the dashboard and mount the central radar display.

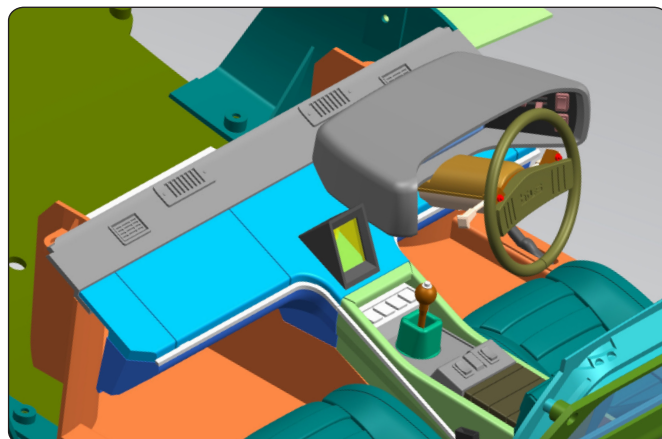

STAGE 037 PARTS LIST

Name
37-A Dashboard vents
37-B Dashboard
37-C Radar housing
37-D Radar glass
37-E Radar LED cable No. 11
Radar sticker
PS02 screws x4

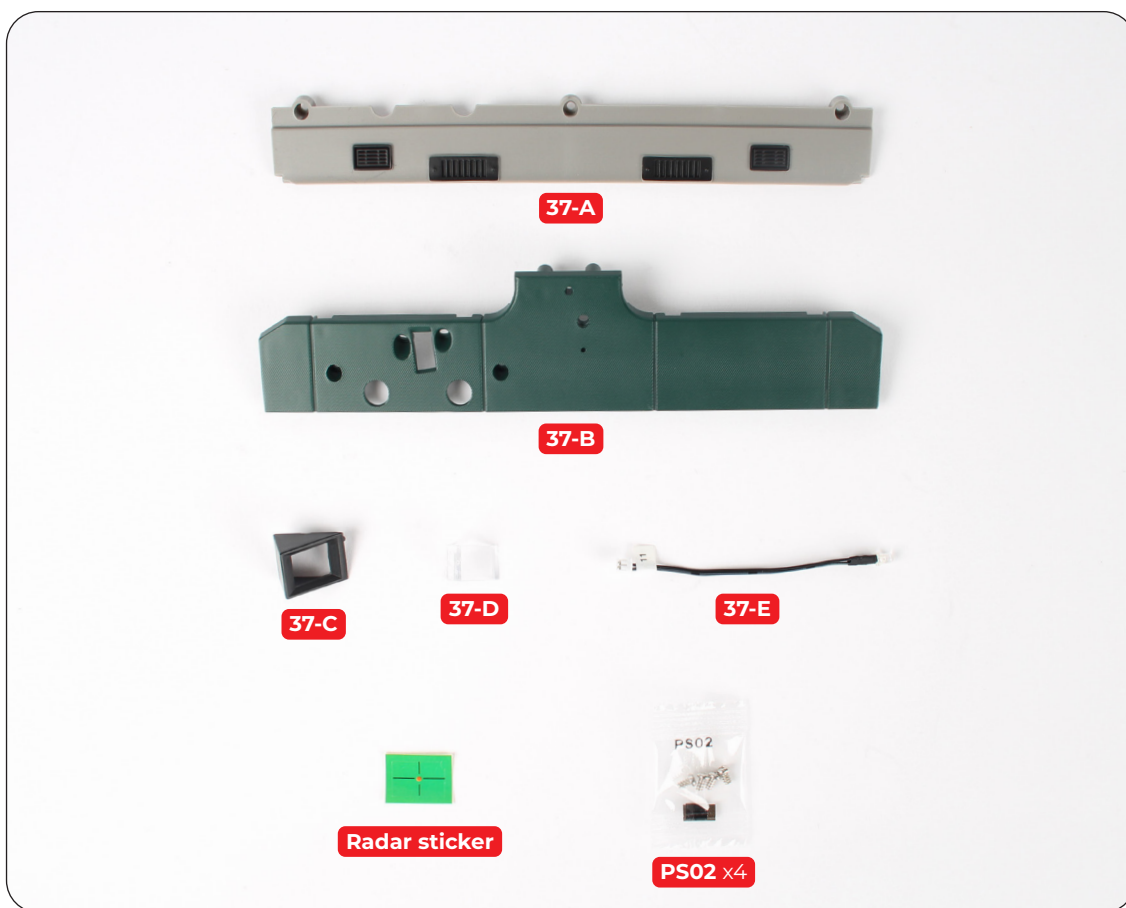

Stage 037: Building the Dashboard and Radar

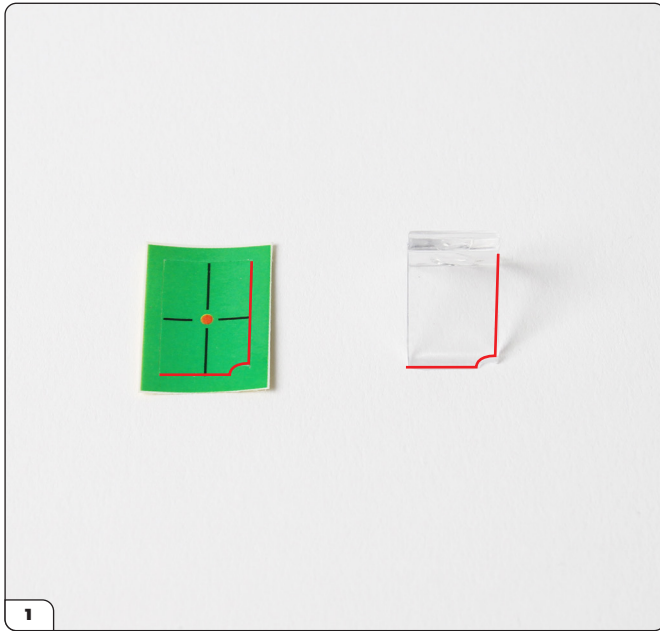

Take the radar glass (37-D) and radar sticker. Note the corner notches indicated by the red lines.

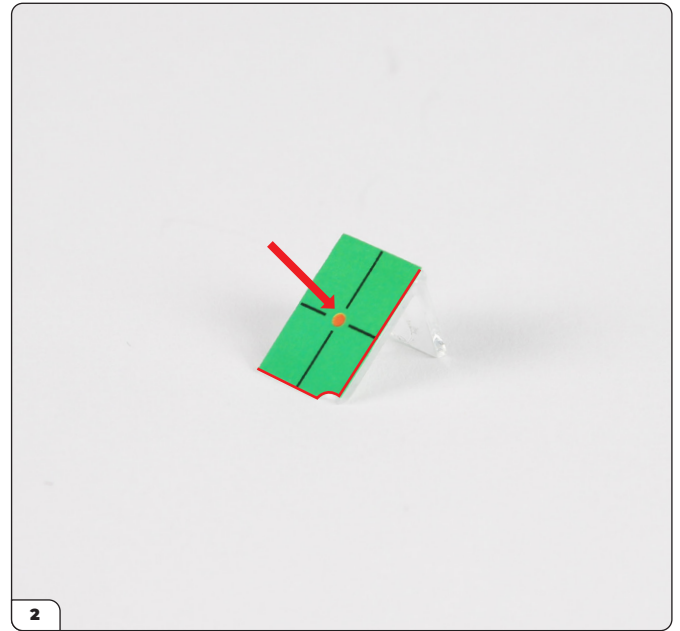

Remove the sticker from backing paper and press it onto the glass, lining up the notches.

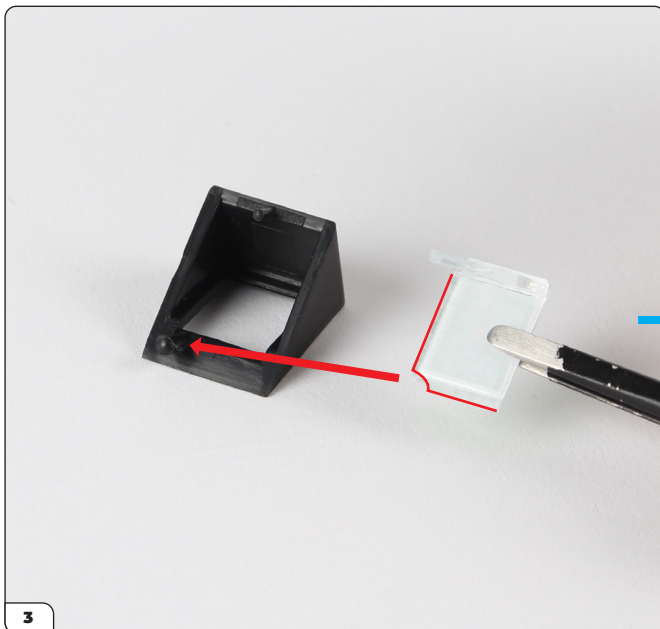

Push the glass into the radar housing (37-C), placing the notch next to the pin, then press firmly in place.



Stage 037: Building the Dashboard and Radar

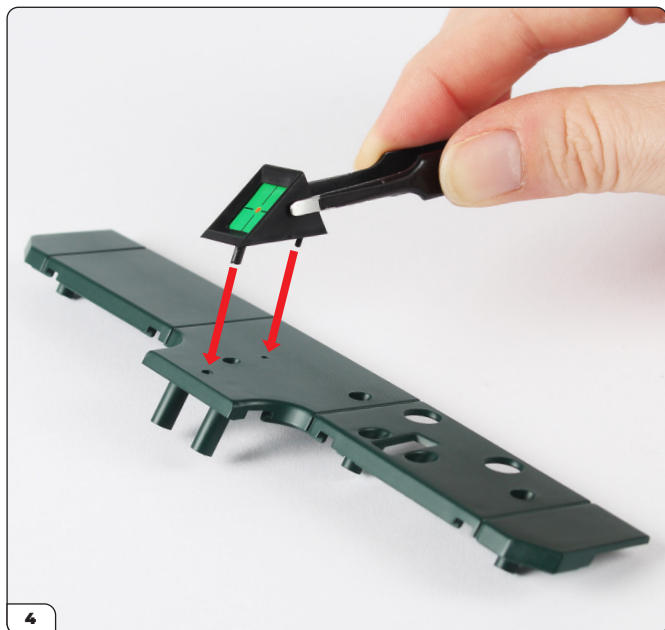

Align the radar housing with the dashboard (37-B).



Press firmly in place.

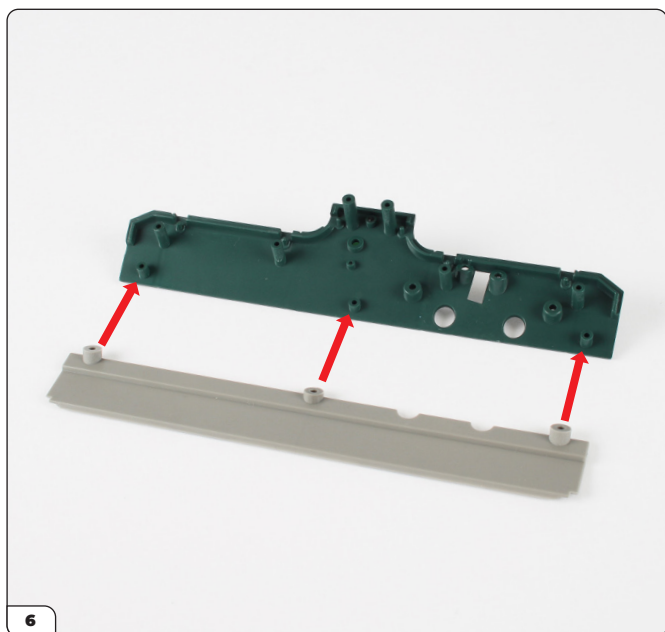

Align the dashboard vents (37-A) with the dashboard as shown.

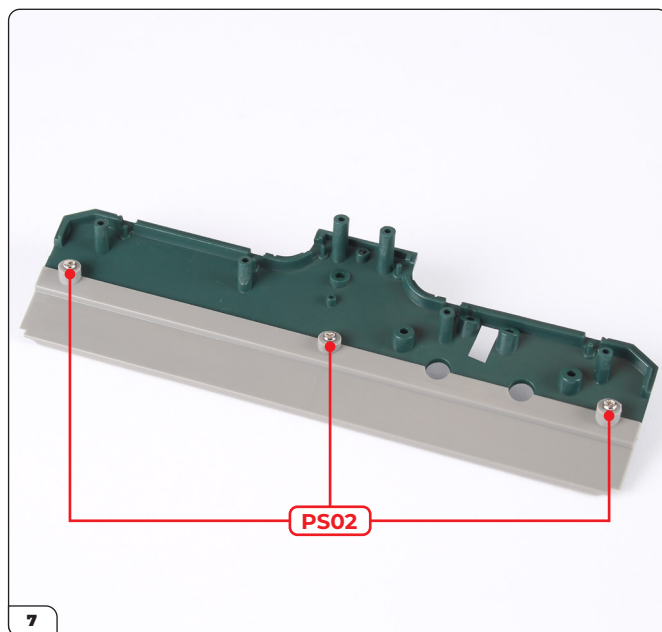

Position it onto the screw posts then secure with 3x PS02 screws.

Stage 037: Building the Dashboard and Radar

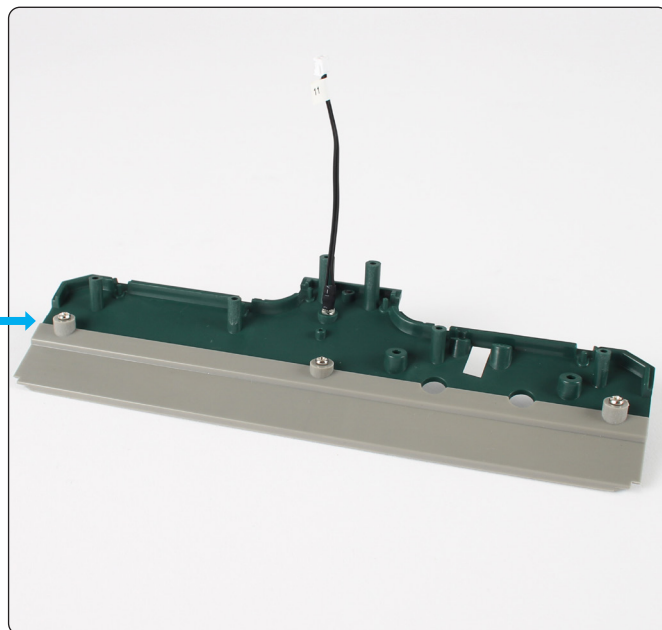
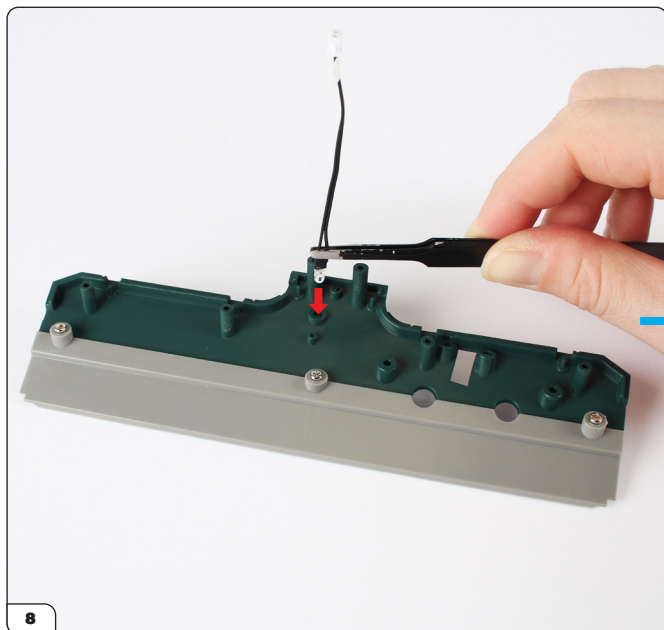

Take the radar LED cable No. 11 (37-E) and press the bulb into the hole.

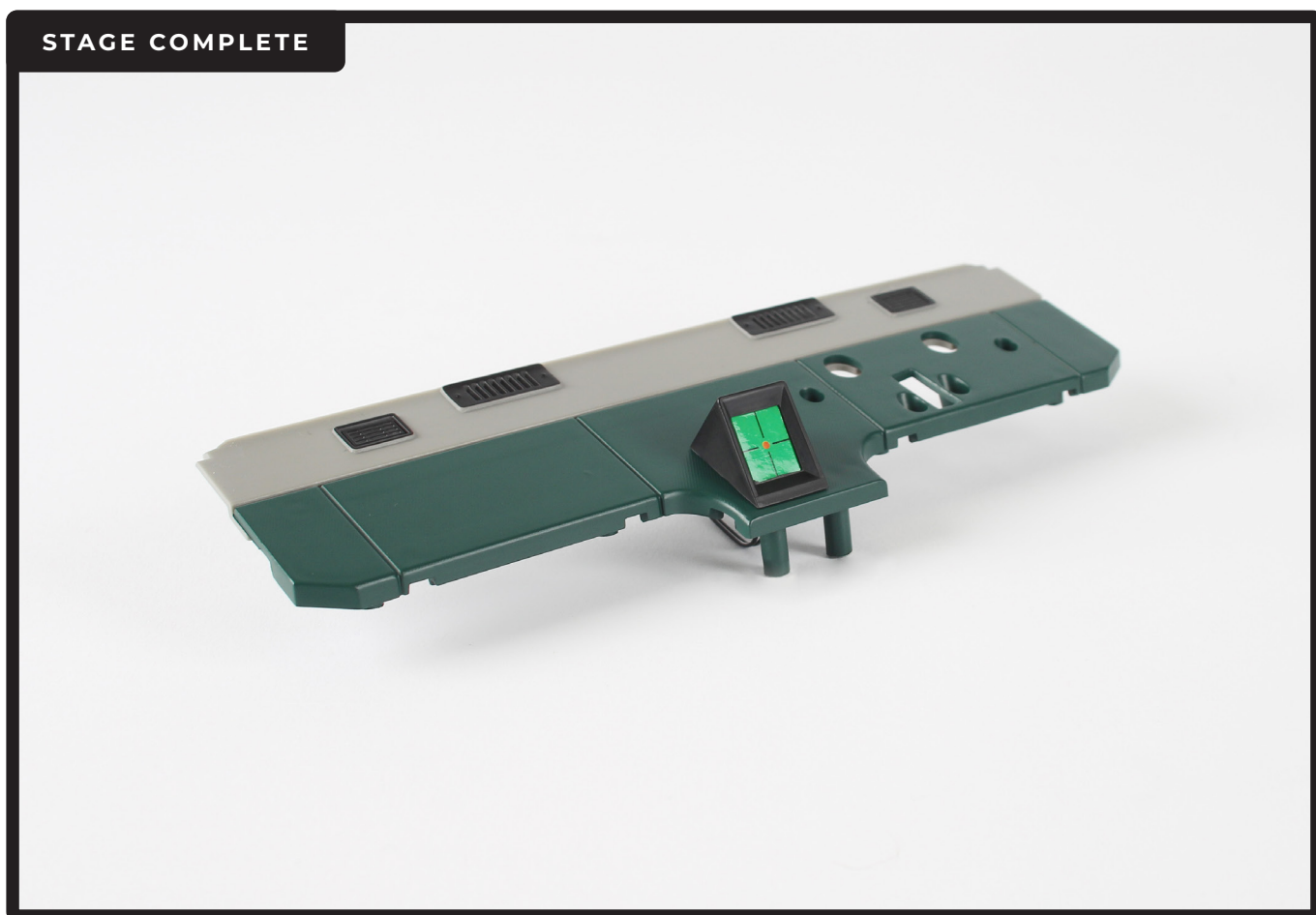

Stage 038: Fitting the Steering Wheel

In this stage you'll assemble the steering wheel and drive shaft then attach it to the dashboard. You'll also fix the instrument panel in place.

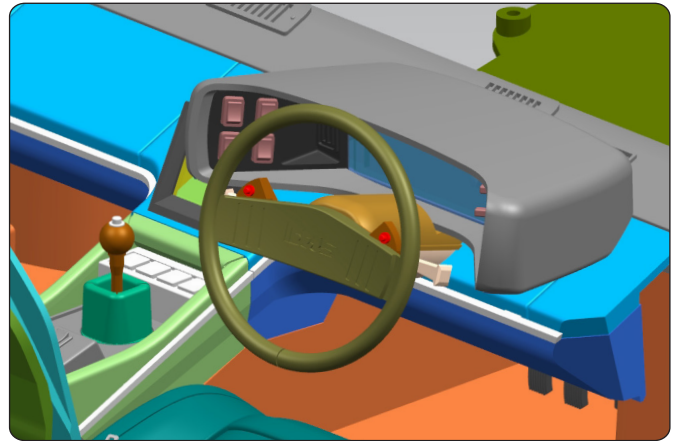

STAGE 038 PARTS LIST

Name	Name
38-A Steering wheel	38-F Crash pad
38-B Drive shaft	DS03 screws x2
38-C Steering column	PS05 screws x5
38-D Steering column cover bottom	PS32 screws x3
38-E Steering column cover top	



Stage 038: Fitting the Steering Wheel



Take the crash pad (38-F) and press it into the back of the steering wheel (38-A).



Push the steering column (38-C) into the D-shaped hole.



Carefully hammer the steering column firmly into place.

Stage 038: Fitting the Steering Wheel



Place the steering column cover top (38-E) onto the column, positioning the disc into the bracket (circled).

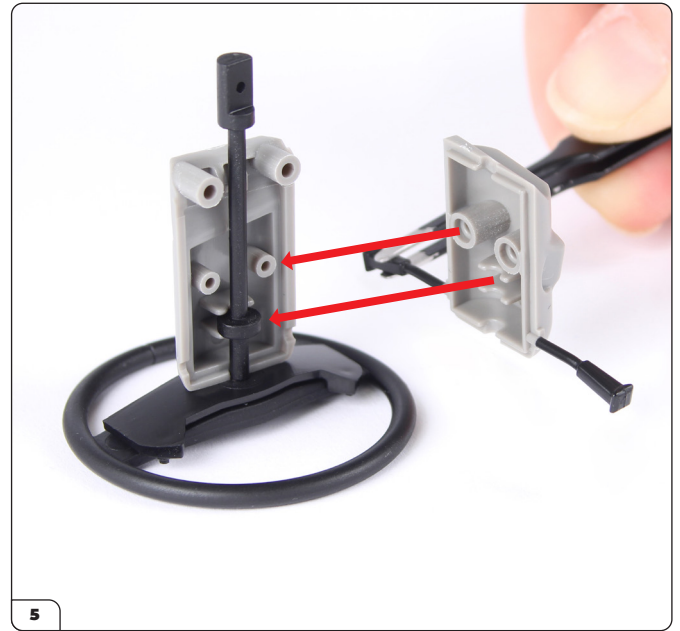

Place the steering column cover bottom (38-D) onto the top part.



Secure together with 2x PS32 screws.

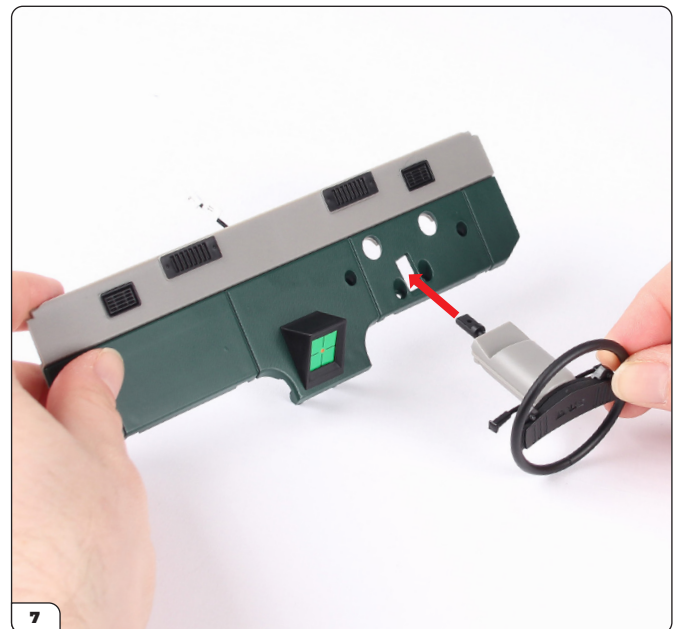

Push the steering column through the opening in the dashboard (stage 037).

Stage 038: Fitting the Steering Wheel



Place the steering column cover into the screw holes as shown.

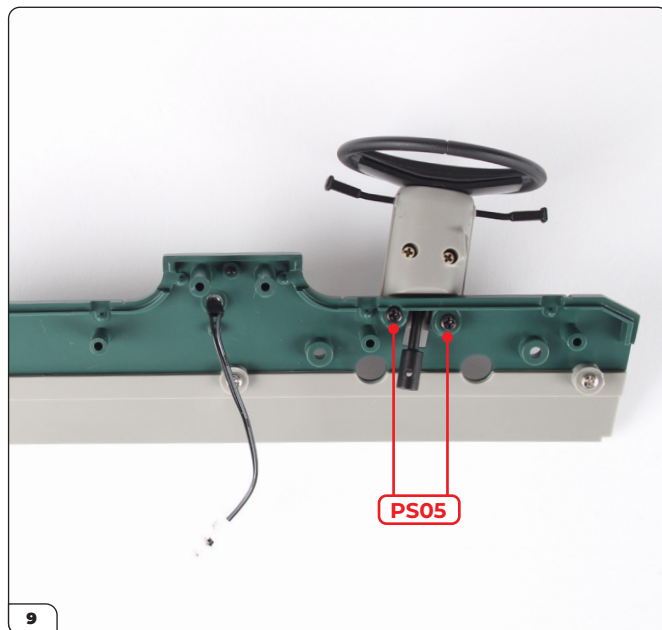

Secure with 2x PS05 screws.

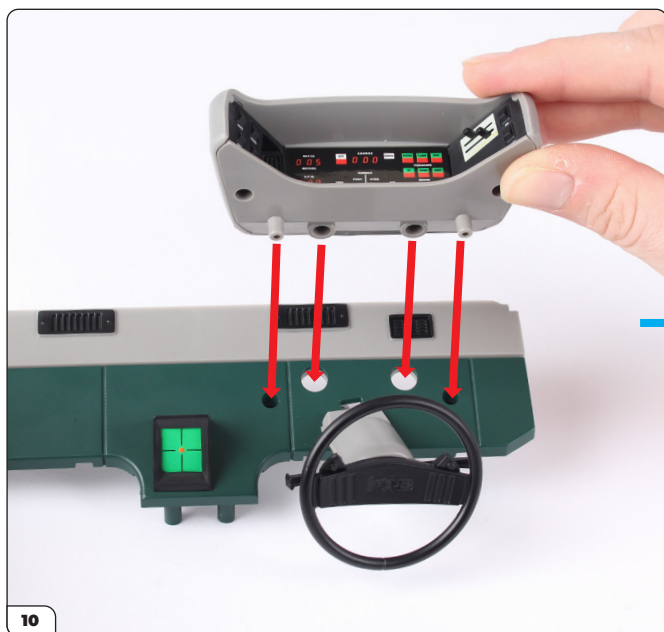

Push the instrument panel (stage 036) into the holes behind the steering wheel.



Stage 038: Fitting the Steering Wheel

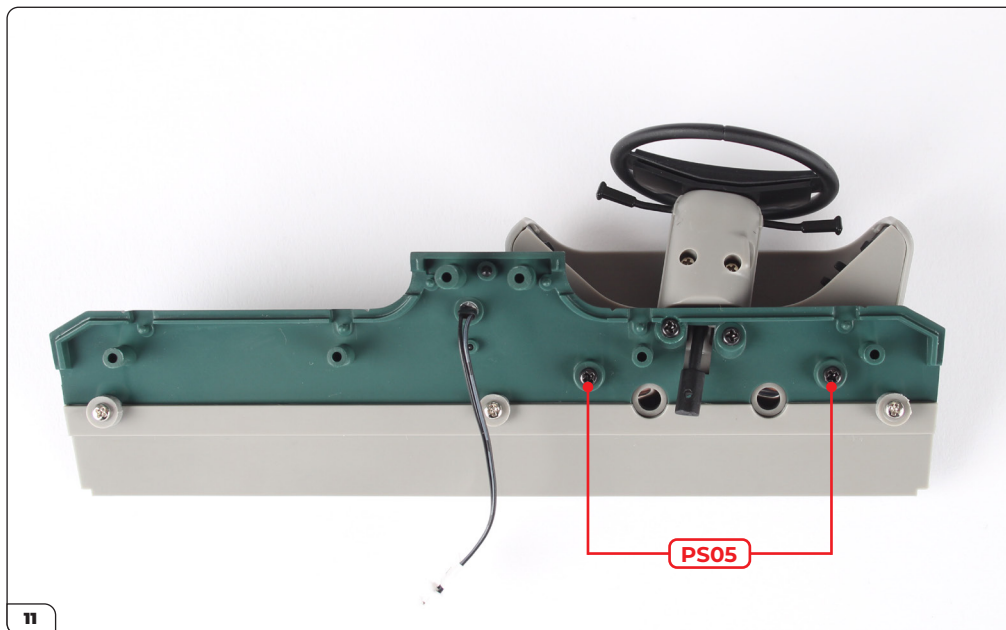

Secure with 2x PS05 screws.

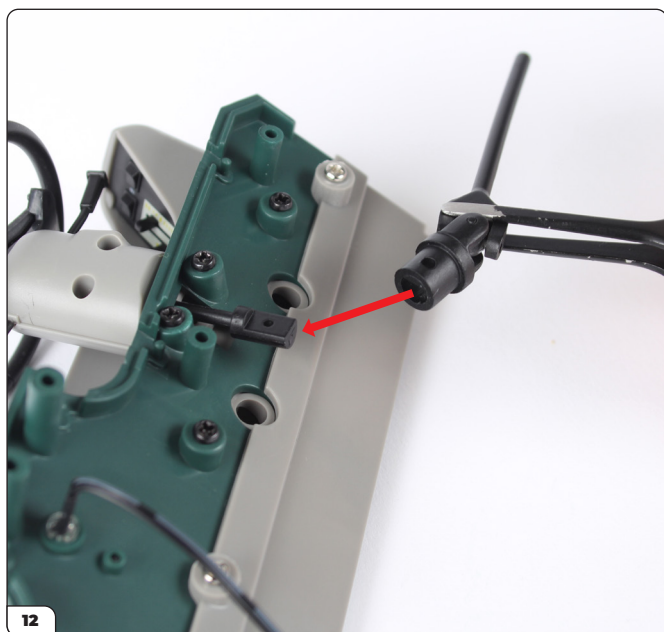

Push the drive shaft (38-B) onto the steering column.

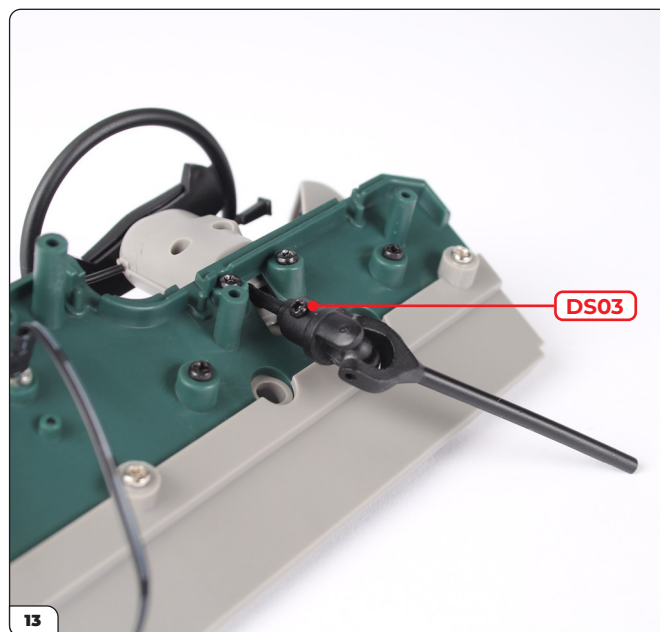

Secure with a DS03 screw.

Stage 038: Fitting the Steering Wheel

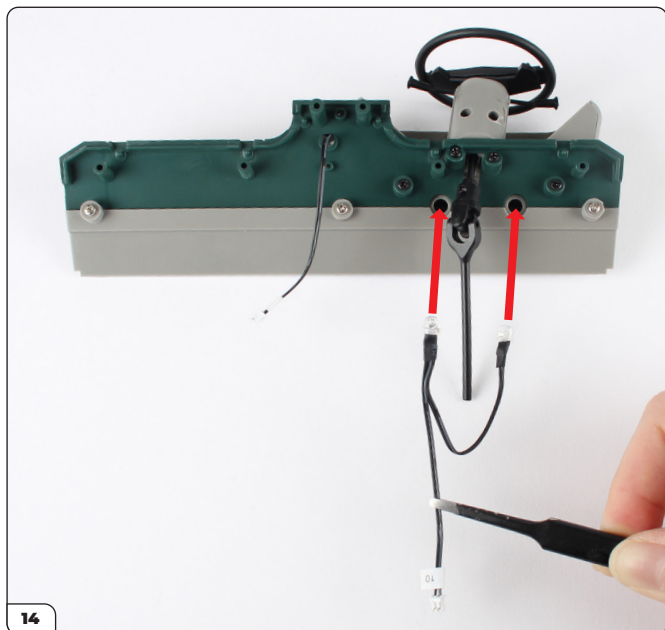

Align the instrument panel LED cable No. 10 (stage 036) with the dashboard as shown.

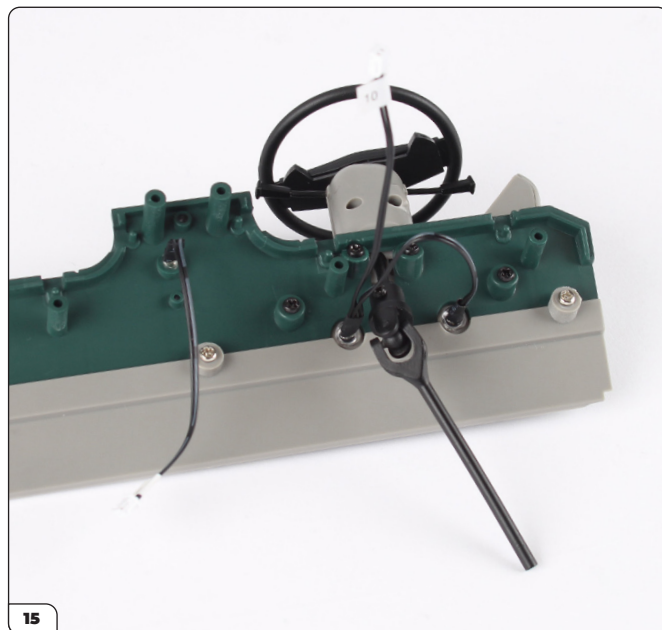

Push the LED bulbs into the holes.

STAGE COMPLETE

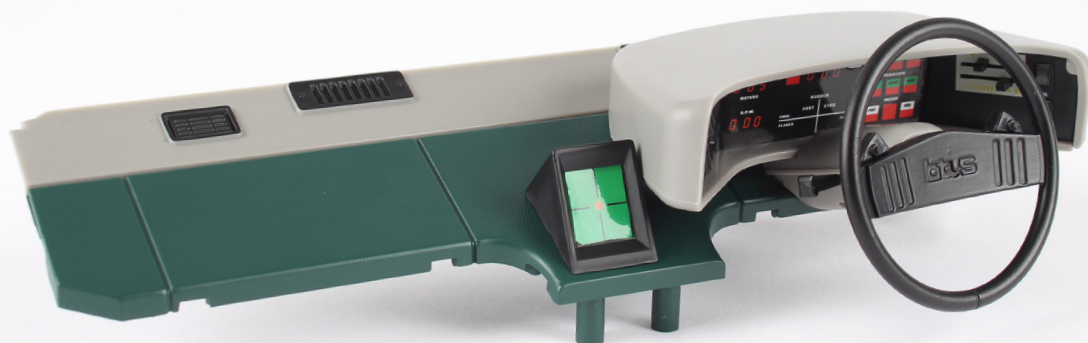

Stage 039: Assembling the Centre Console (I)

In this stage you'll begin to assemble the centre console, starting with the side panels, trims and belt buckles.

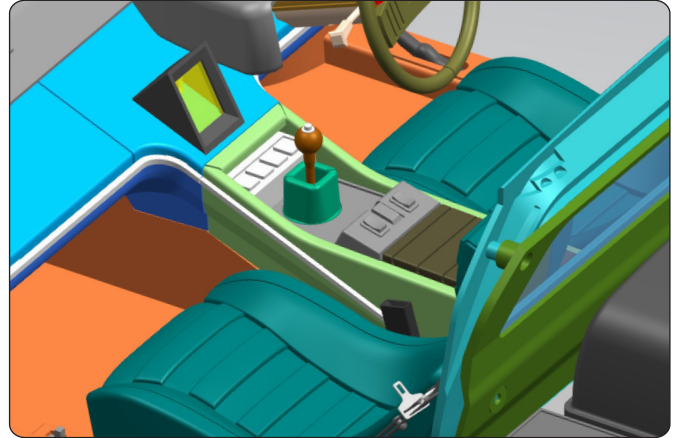

STAGE 039 PARTS LIST

Name	Name
39-A Centre console	39-F Right trim
39-B Centre console panel	39-G Right belt buckle
39-C Right panel	39-H Left belt buckle
39-D Left trim	PS05 screws x2
39-E Left panel	

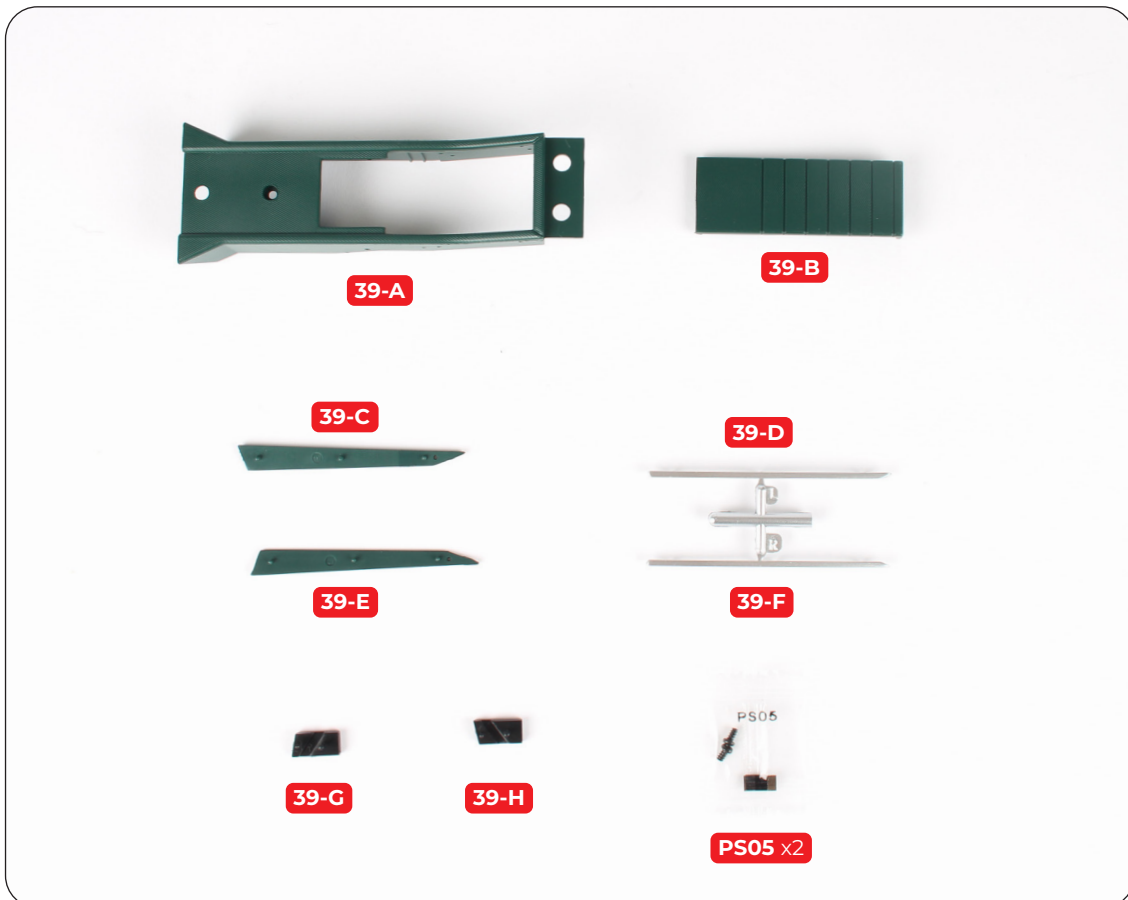

Stage 039: Assembling the Centre Console (I)

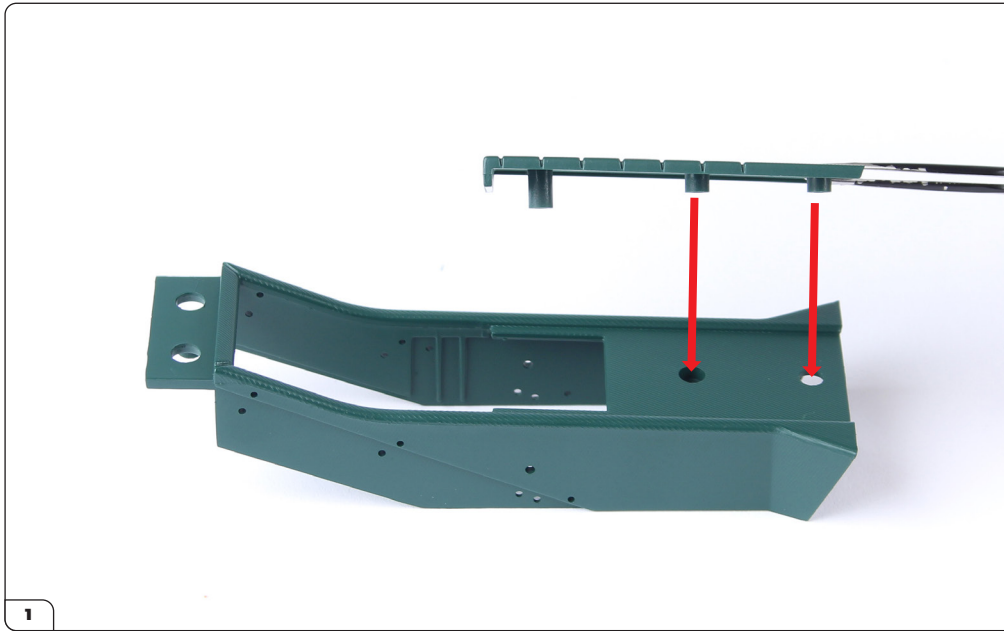

Take the centre console (39-A) and the centre console panel (39-B) and align them as shown.



Push the panel in place.



Secure with a PS05 screw.

Stage 039: Assembling the Centre Console (I)

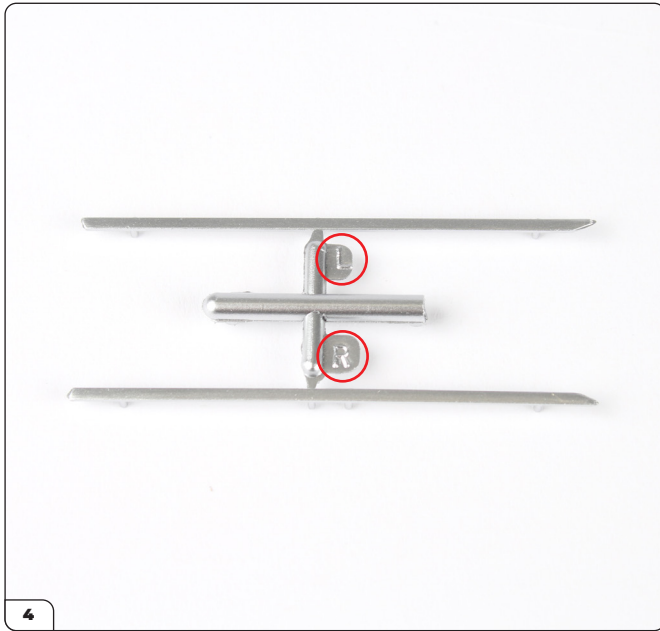

Take the left (39-D) and right (39-F) trim. The sprue is marked with "L" and "R" to identify them.

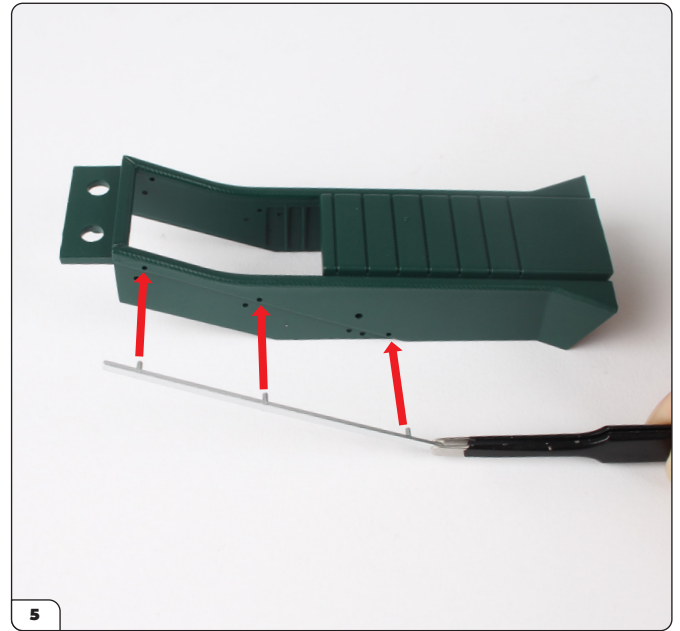

Cut the left trim from the sprue and align it with the centre console.



Press the trim into the holes.

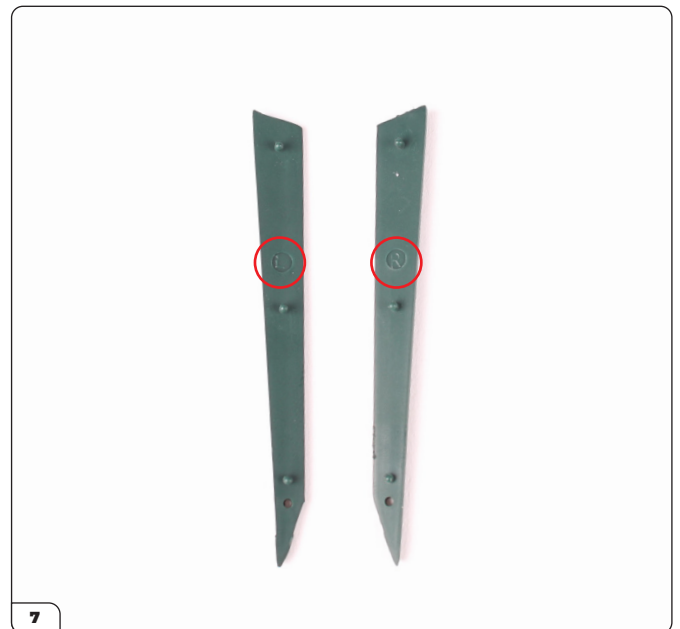

Take the left (39-E) and right (39-C) panels, which are marked with "L" and "R".

Stage 039: Assembling the Centre Console (I)



Align the left panel with the holes below the trim.



Press the panel in place.



Take the left (39-H) and right (39-G) belt buckles, which are marked with "L" and "R".



Align the left belt buckle with the centre console as shown. The pins and holes are different sizes.

Stage 039: Assembling the Centre Console (I)



Push the left belt buckle in place.

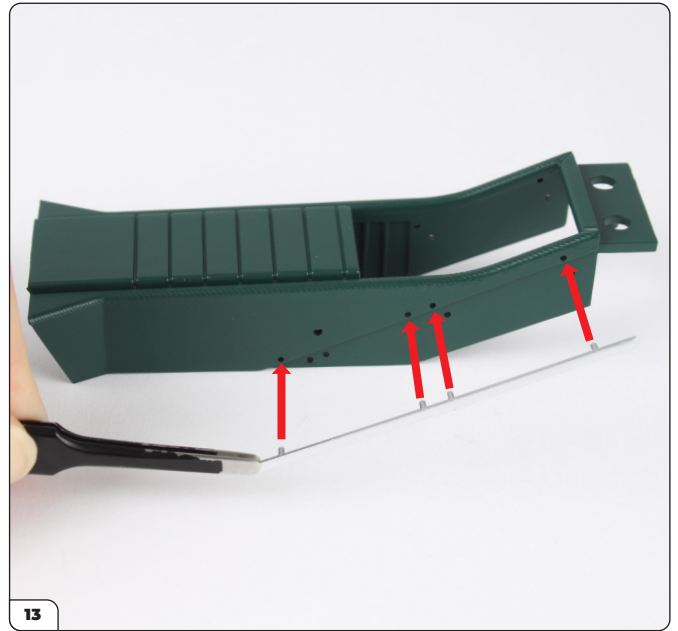

You'll now repeat these steps on the right side of the centre console. Cut the right trim from the sprue and press it into the holes.

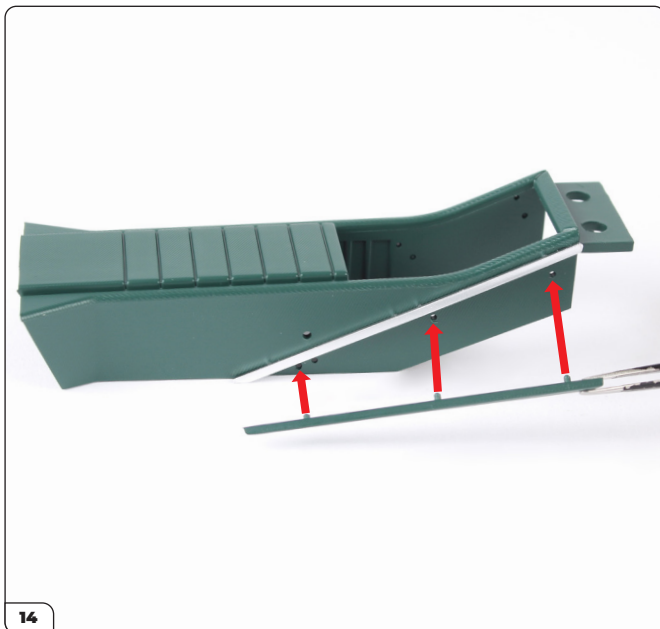

Press the right panel into the holes below the trim.



Push the right belt buckle in place.

Stage 039: Assembling the Centre Console (I)



The right side of the centre console should now look like this.



Stage 040: Assembling the Centre Console (II)

You'll continue to assemble the centre console by adding the switches, gadget controls and gear stick.

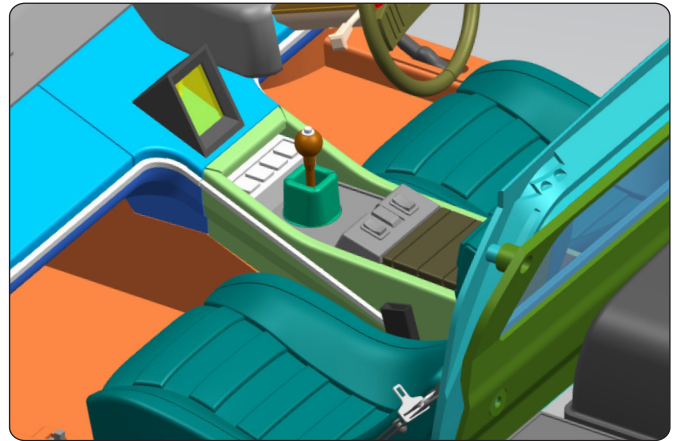

STAGE 040 PARTS LIST

Name
40-A Centre console switches
40-B Centre console gadget controls
40-C Gear stick gaiter
40-D Gear stick
40-E Missile trigger
PS02 screws x4



Stage 040: Assembling the Centre Console (II)

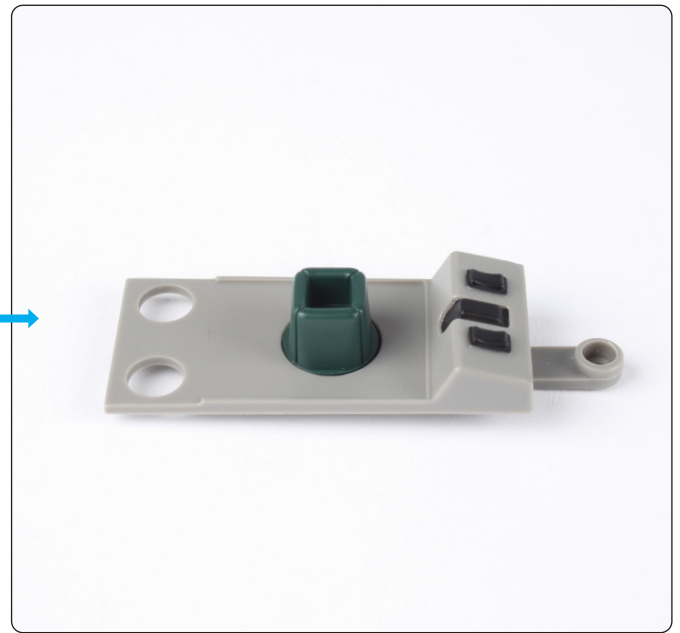
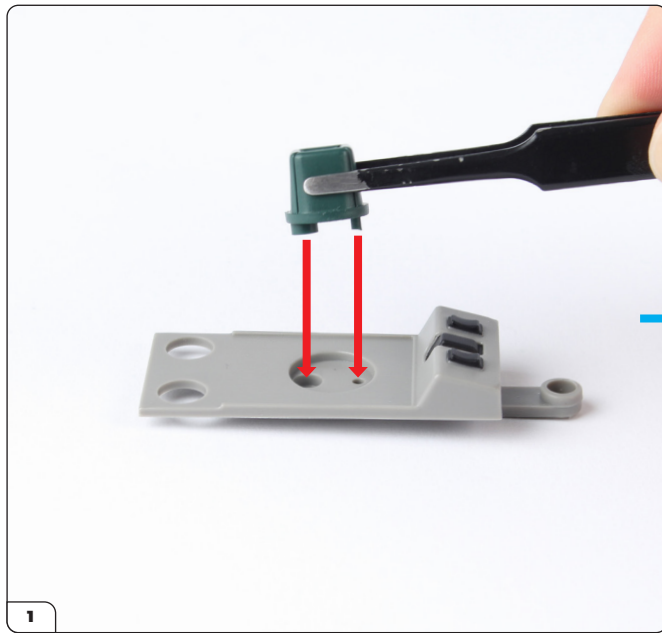

Take the gear stick gaiter (40-C) and press it into the centre console switches (40-A).



Secure from underneath with a PS02 screw.

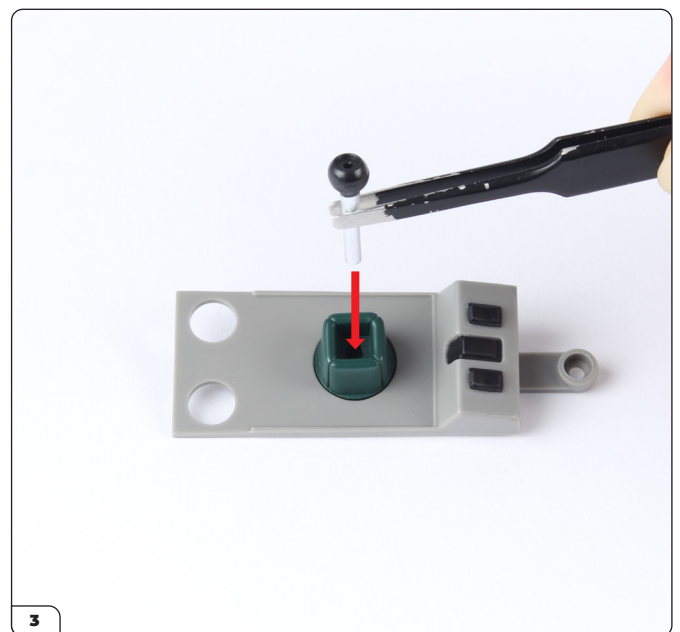

Push the gear stick (40-D) into the gaiter.

Stage 040: Assembling the Centre Console (II)

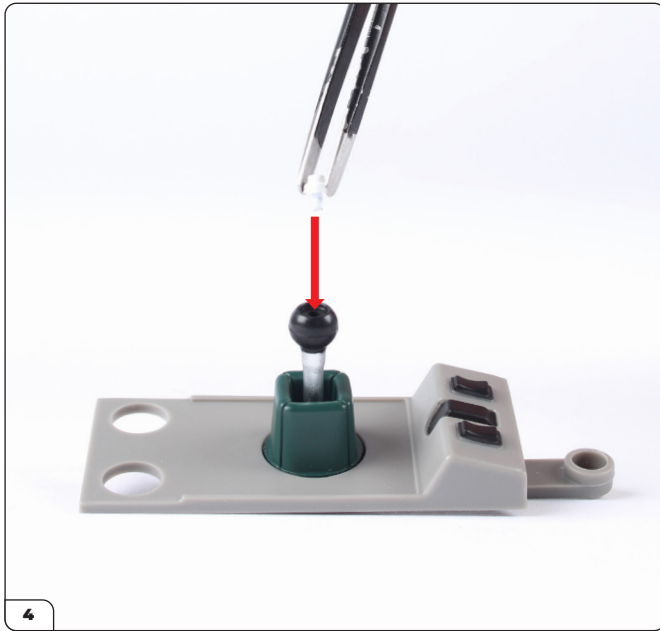

Push the missile trigger (40-E) into the top of the gear stick.



The assembly should look like this.



Take the centre console gadget controls (40-B) and align it with the centre console (stage 039) as shown.



Place the gadget controls then secure with a PS02 screw.

Stage 040: Assembling the Centre Console (II)

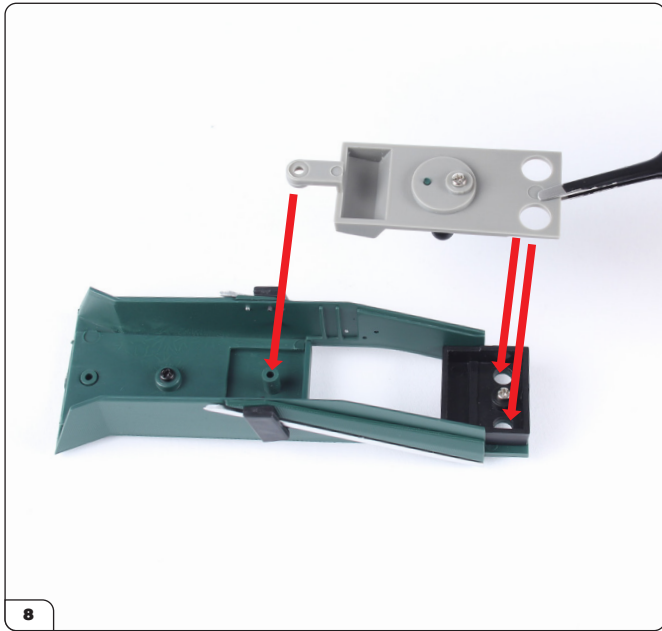

Align the centre console buttons and gear stick with the assembly as shown.



Push in place and secure with a PS02 screw.



Stage 041: Fitting the Centre Console and Dashboard Trim

In this stage you'll fit the centre console and finish building the dashboard by fixing the bottom panel.

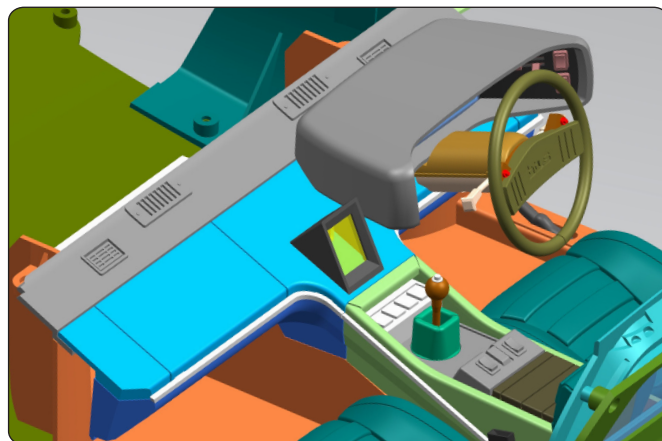

STAGE 041 PARTS LIST

Name
41-A Dashboard bottom panel
41-B Dashboard left trim
41-C Dashboard right trim
PS05 screws x7

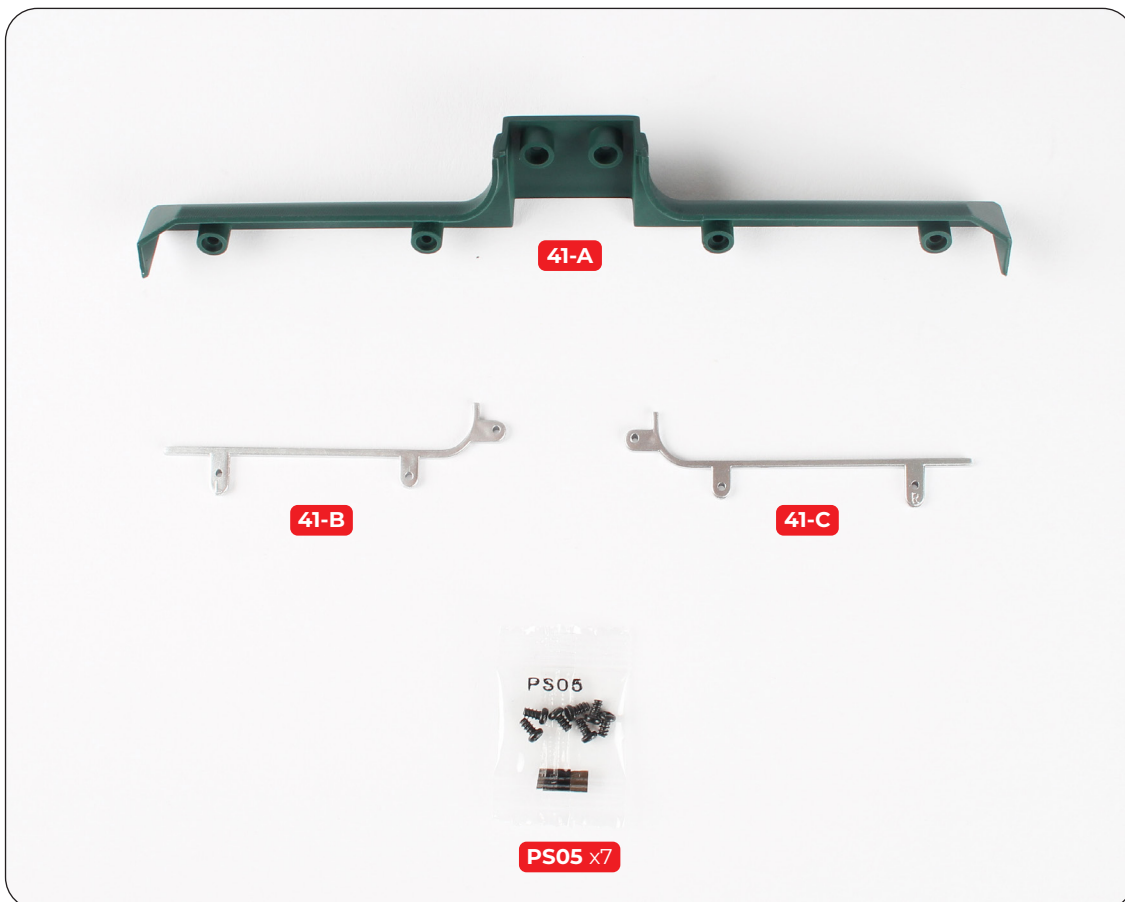

Stage 041: Fitting the Centre Console and Dashboard Trim

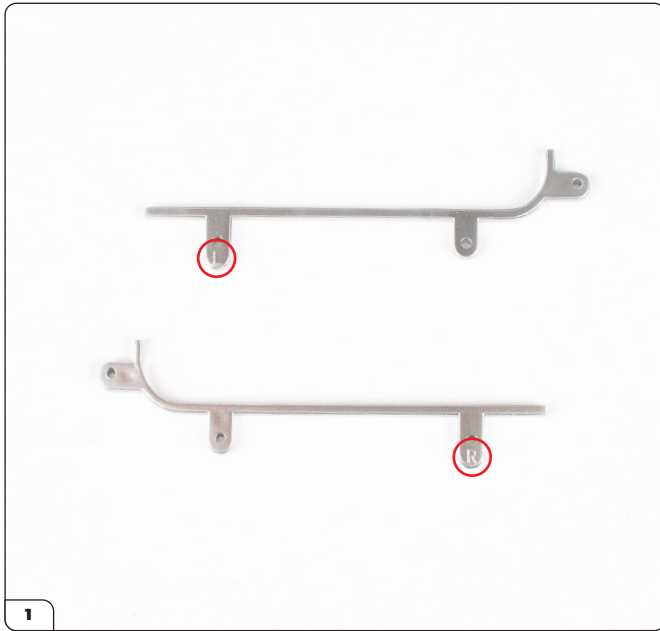

Take the left (41-B) and right (41-C) dashboard trim pieces, which are marked with "L" and "R".

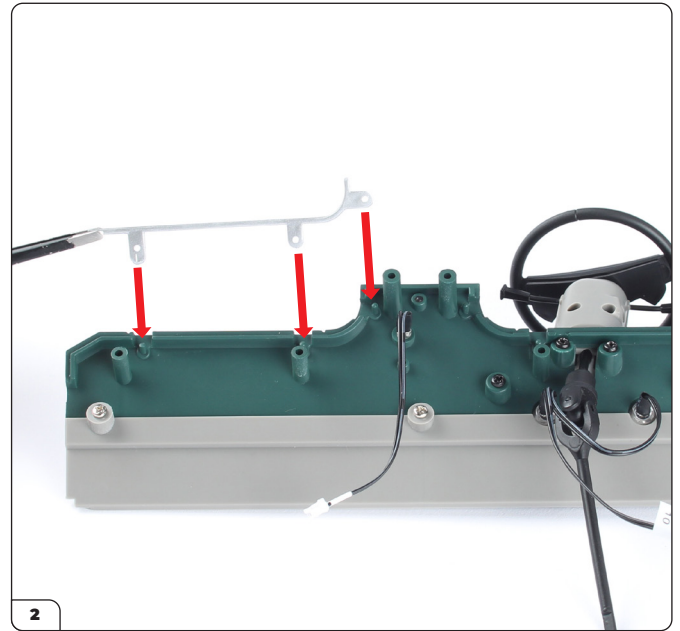

Align the left dashboard trim with the dashboard assembly (stage 039) as shown.

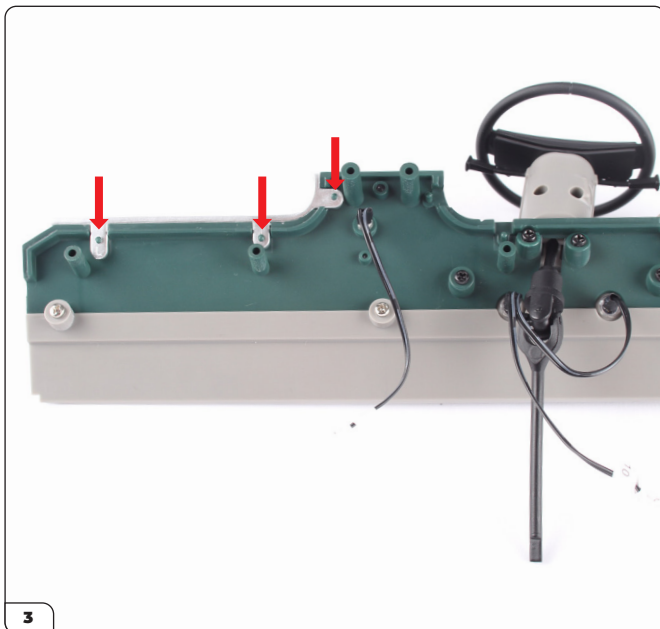

Press the trim firmly in place, making sure there are no gaps between the trim and the dashboard as shown in 3a.

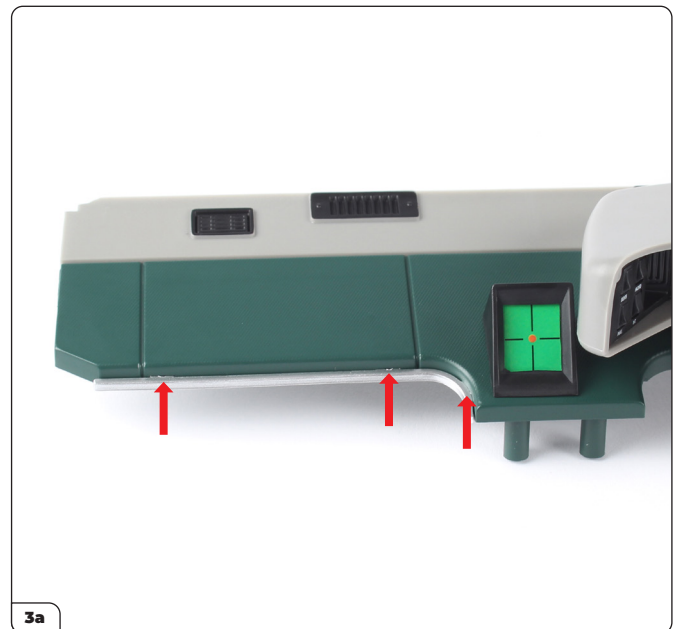

Stage 041: Fitting the Centre Console and Dashboard Trim

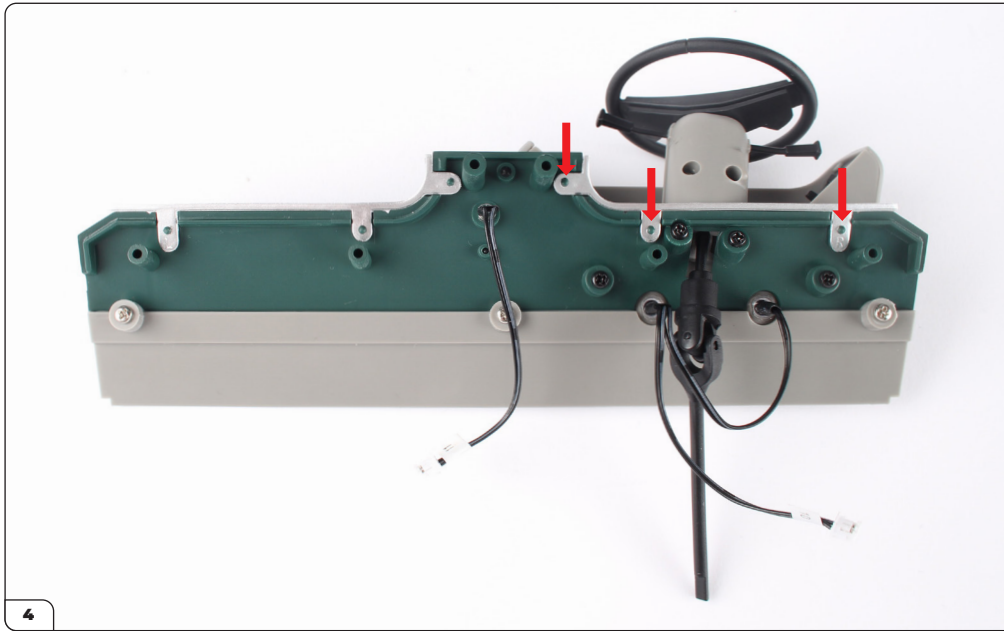

Fit the right dashboard trim in the same way.

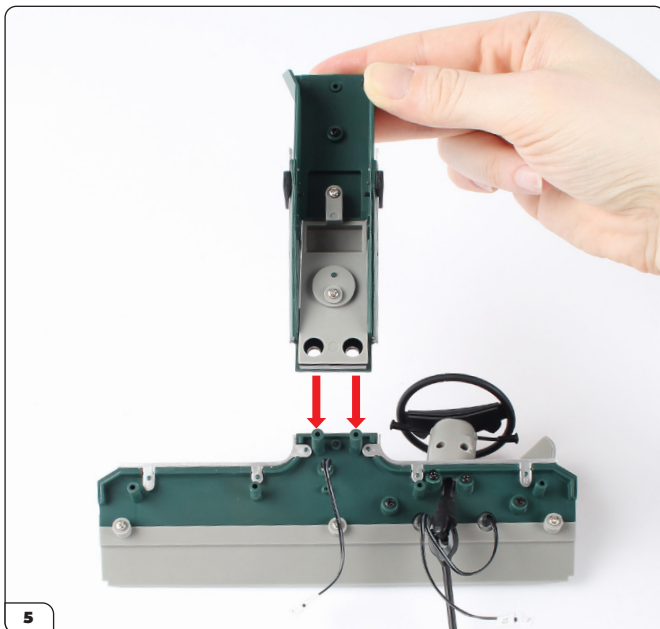

Take the centre console (stage 040) and align it with the dashboard assembly as shown.

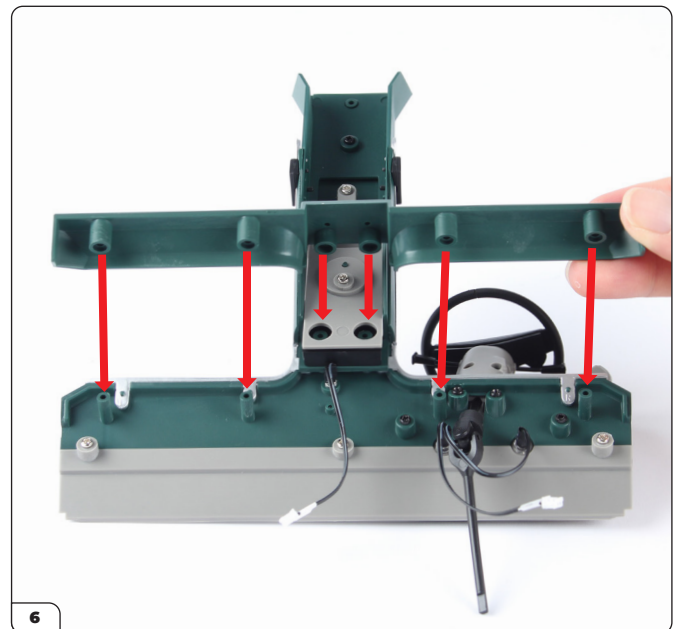

Position the centre console over the two middle screw posts, then align the dashboard bottom panel as shown.

Stage 041: Fitting the Centre Console and Dashboard Trim

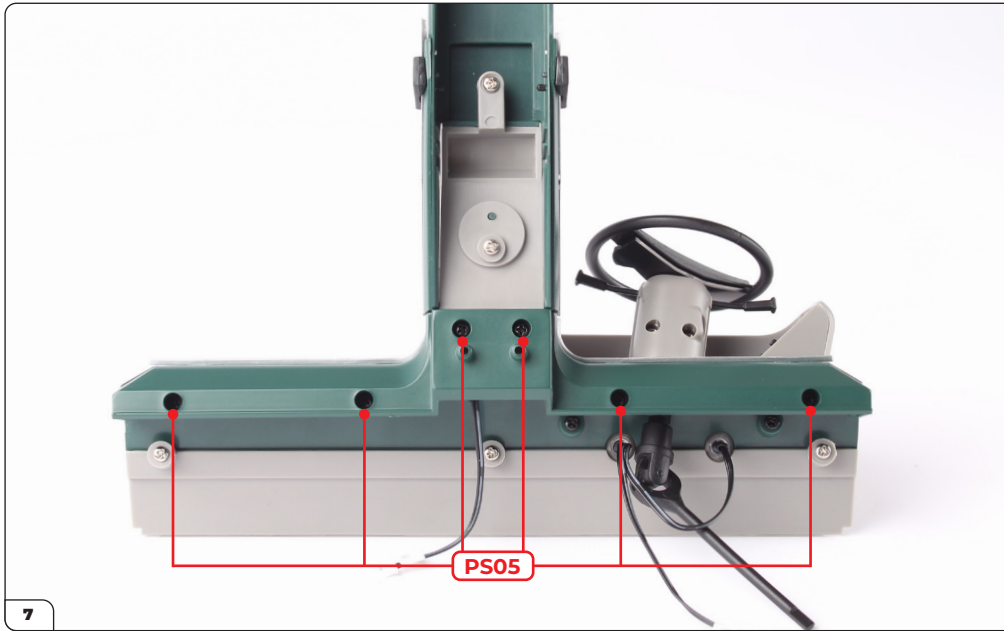

Press the bottom panel firmly in place then secure the parts with 6x PS05 screws. If there are any gaps between the dashboard parts, you can try removing some of the screw posts with a file.

STAGE COMPLETE



Stage 042: Adding Carpet to the Cockpit Floor

In this stage you'll stick the carpet to the cockpit floor then attach the pedals, handbrake and power switch.

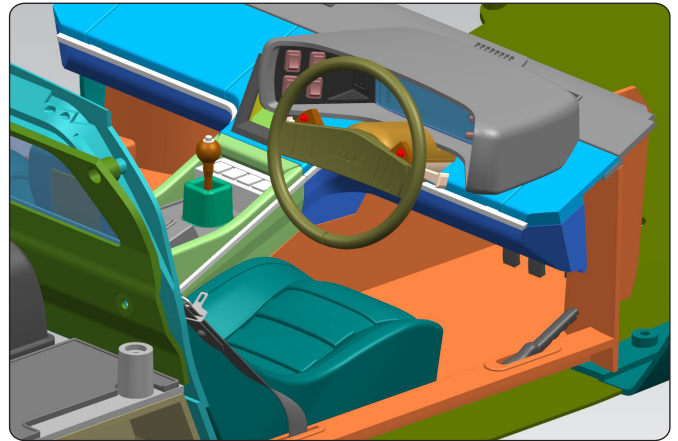

STAGE 042 PARTS LIST

Name	Name
42-A Cockpit floor	42-F Power switch cable No. 13
42-B Pedals	PS05 screws x2
42-C Handbrake	PS14 screws x4
42-D Cable bracket x2	Carpet sticker sheet A
42-E Power switch bracket	Carpet sticker sheet B

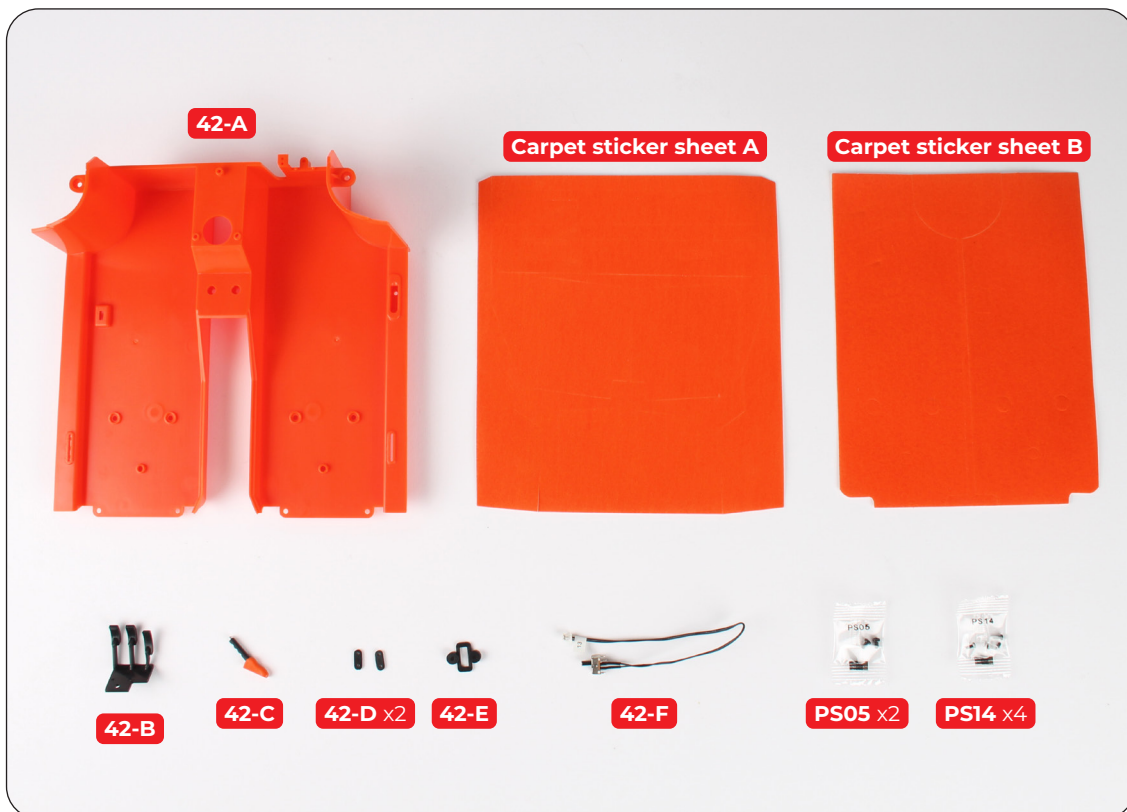

Stage 042: Adding Carpet to the Cockpit Floor

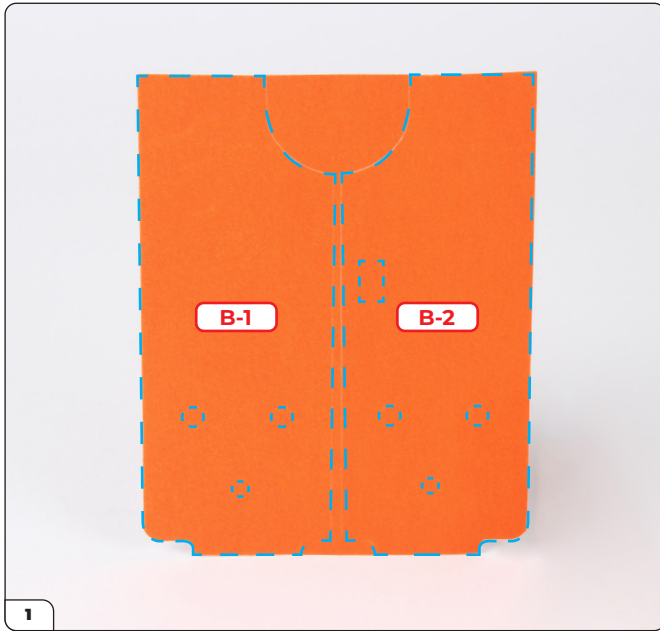

FITTING THE CARPET

There are two stickers on carpet sticker sheet B. They will be referred to by the part names shown above.

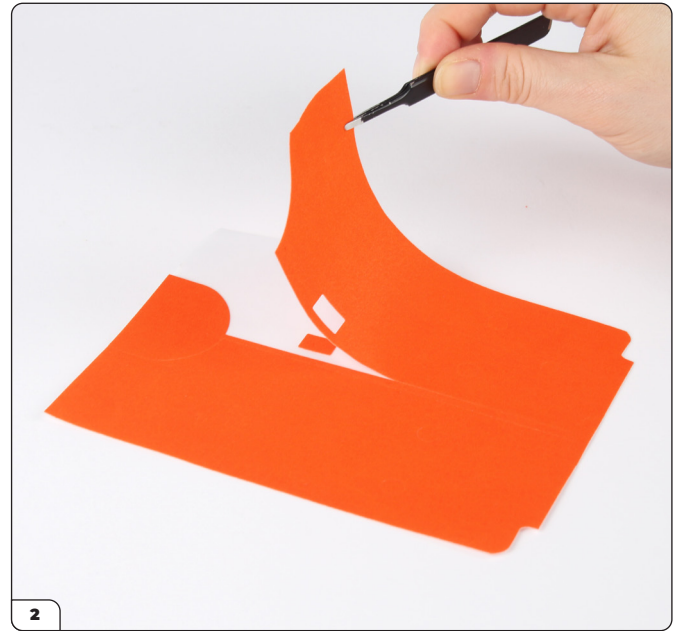

Remove sticker B-2 from the backing paper.

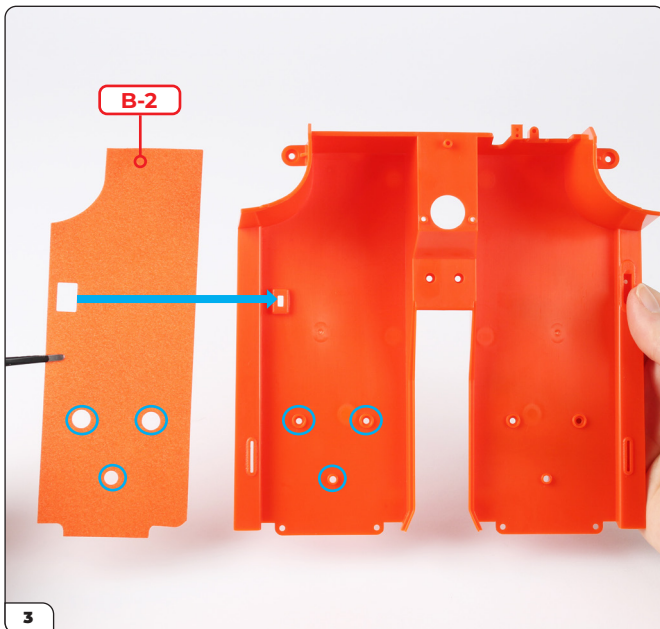

Align sticker B-2 with the left-hand side of the cockpit floor (42-A). Note the openings which correspond to the screw holes (circled) and rectangular mount (arrow).



Press sticker B-2 into place, making sure to align the openings and the edges.

Stage 042: Adding Carpet to the Cockpit Floor



Remove sticker B-1 from the backing paper and align it with the right-hand side of the cockpit floor.

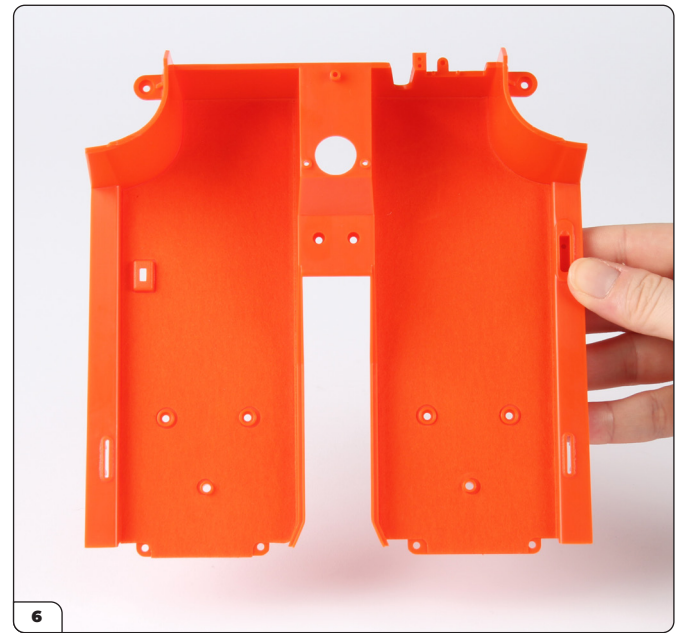

Press sticker B-1 into place, making sure to align the openings and the edges.

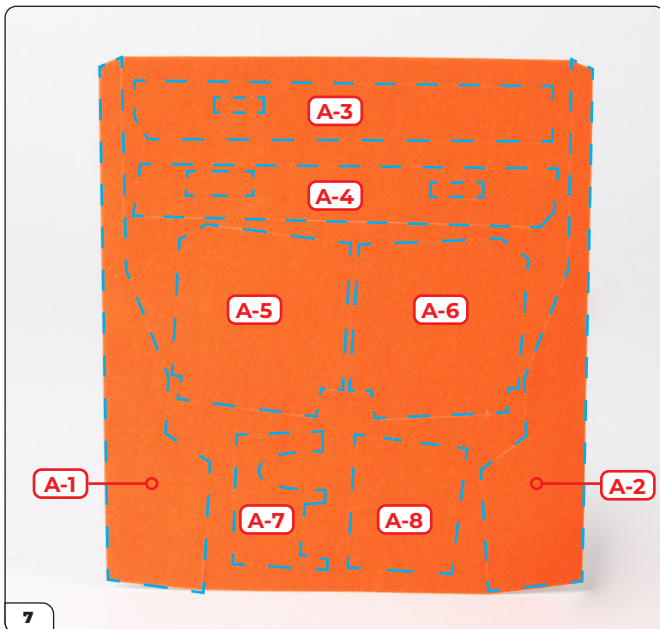

There are eight stickers on carpet sticker sheet A. They will be referred to by the part names shown above.

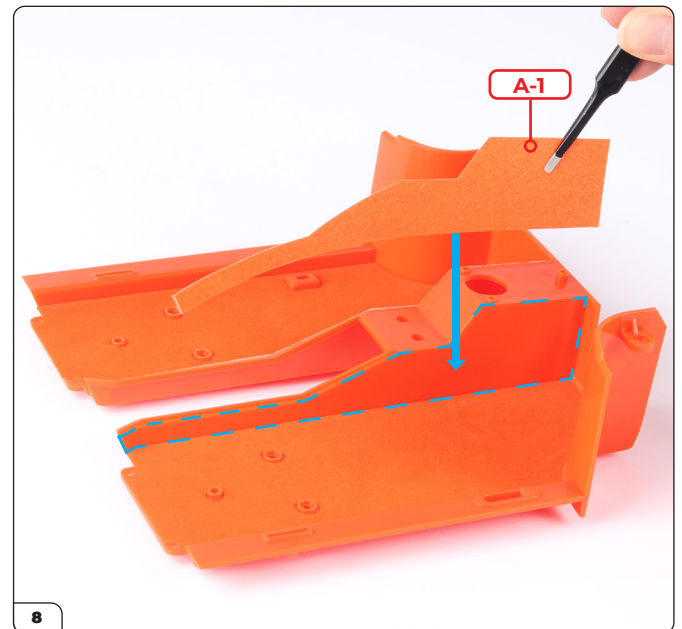

Remove sticker A-1 from the backing paper and align it with the right-hand side of the transmission tunnel.

Stage 042: Adding Carpet to the Cockpit Floor

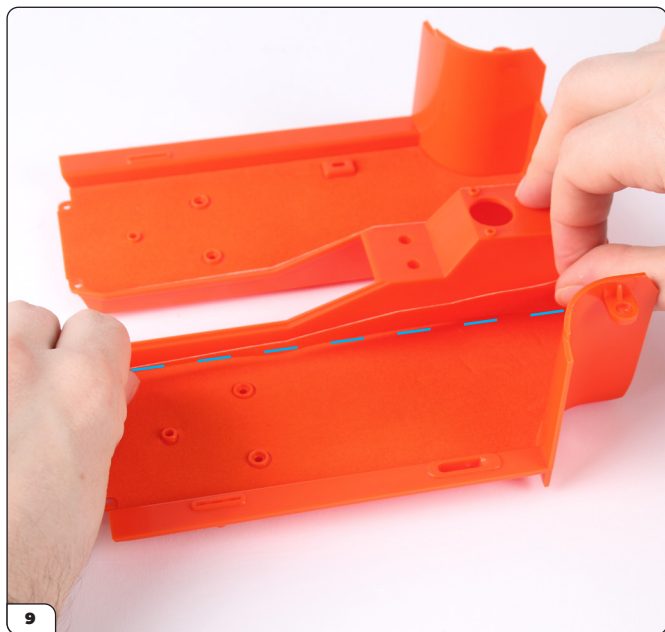

Align the bottom edge with the edge of sticker B-1 as shown by the dashed line.

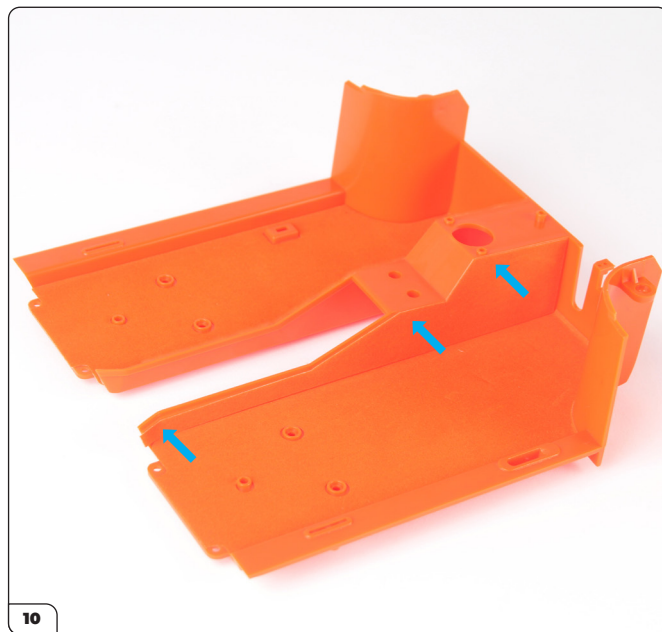

Press sticker A-1 in place.

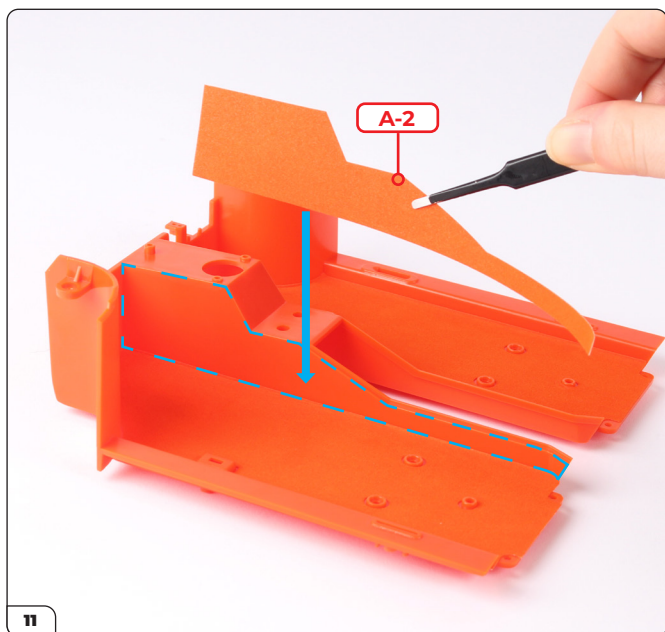

Remove sticker A-2 and align it with the other side, then press it into place in the same way.

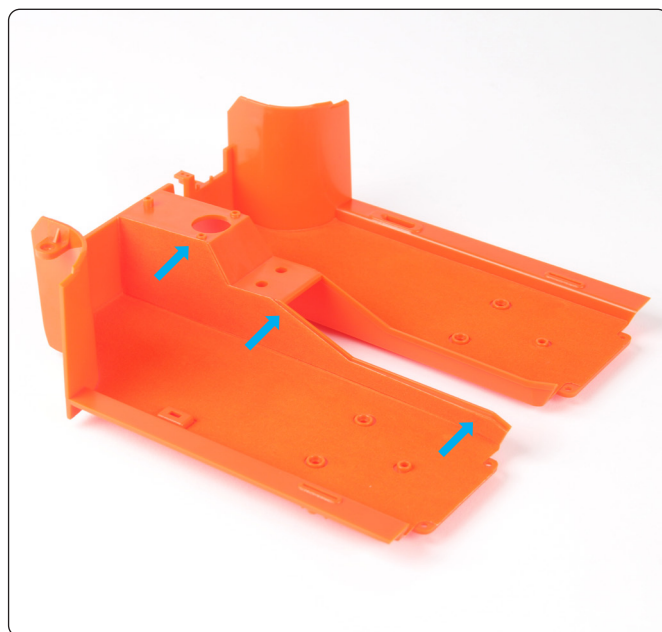

Stage 042: Adding Carpet to the Cockpit Floor

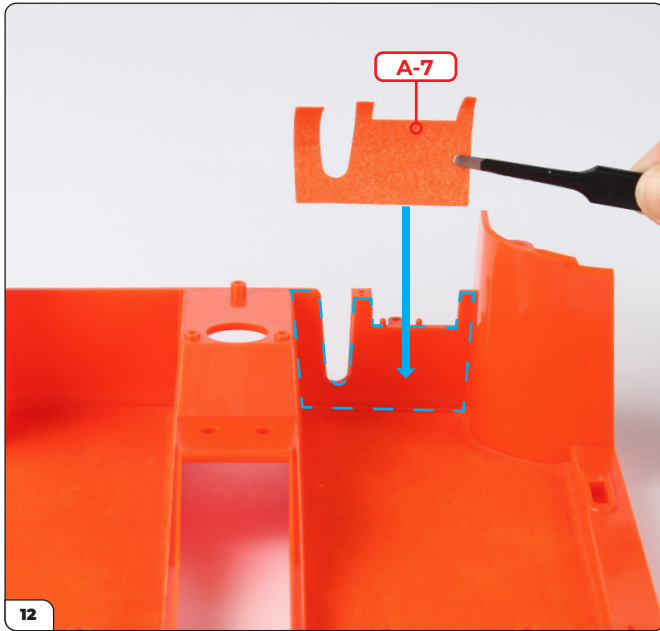

Remove sticker A-7 and align it with the area on the right-hand side in the driver's footwell.

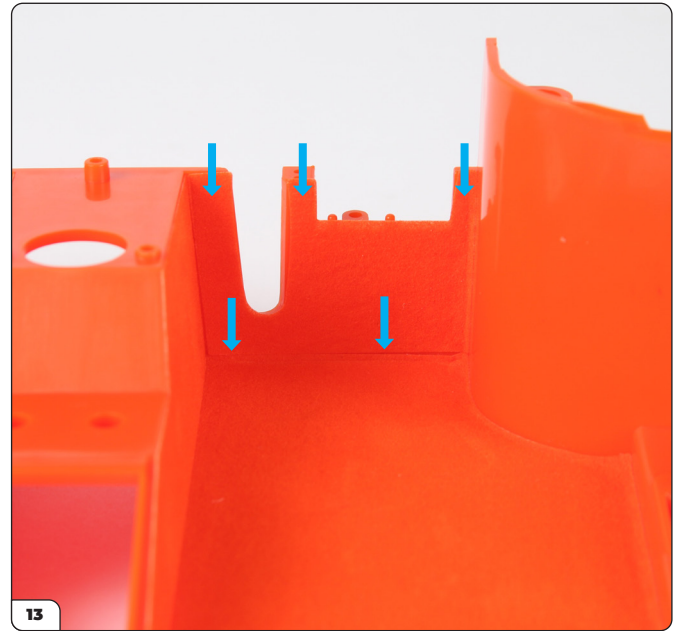

Press the sticker in place.

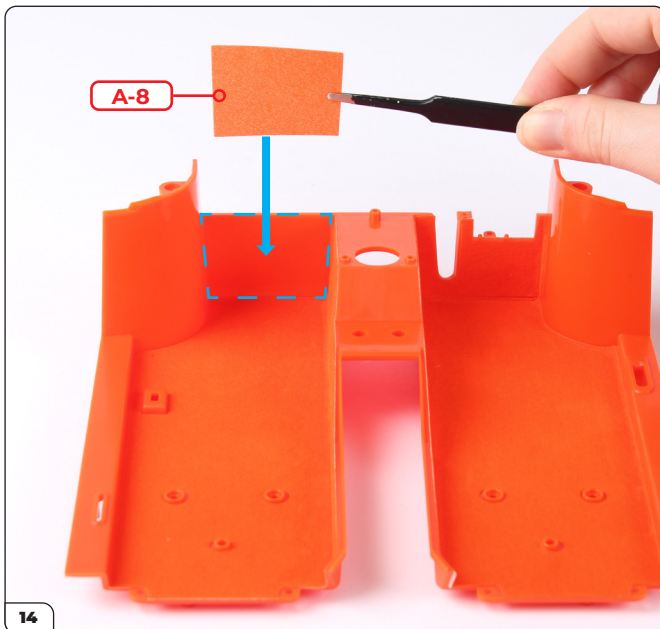

Remove sticker A-8 and align it with the area on the left-hand side in the passenger's footwell.

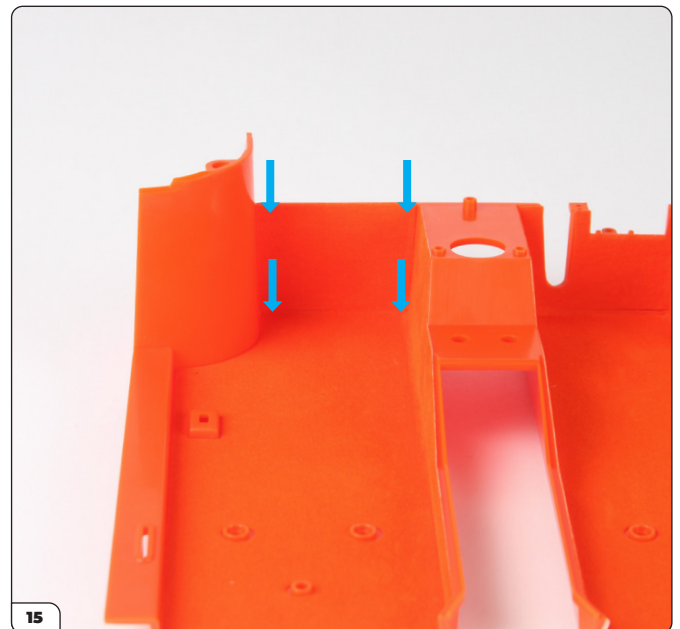

Check the alignment of the edges carefully as the sticker is not perfectly square, then press the sticker in place.

Stage 042: Adding Carpet to the Cockpit Floor

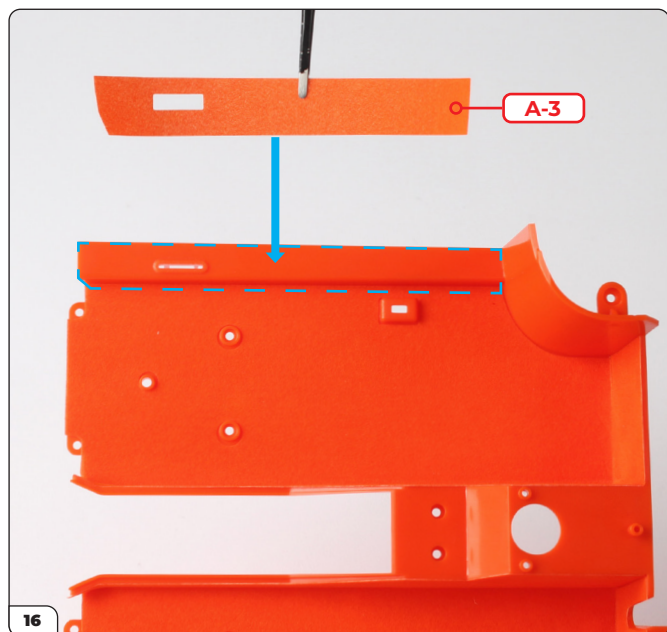

Remove sticker A-3 and align it with the left hand side as shown.



Press the sticker onto the left hand side, aligning the outside edges first (dashed line).



Fold and press the bottom edge down.

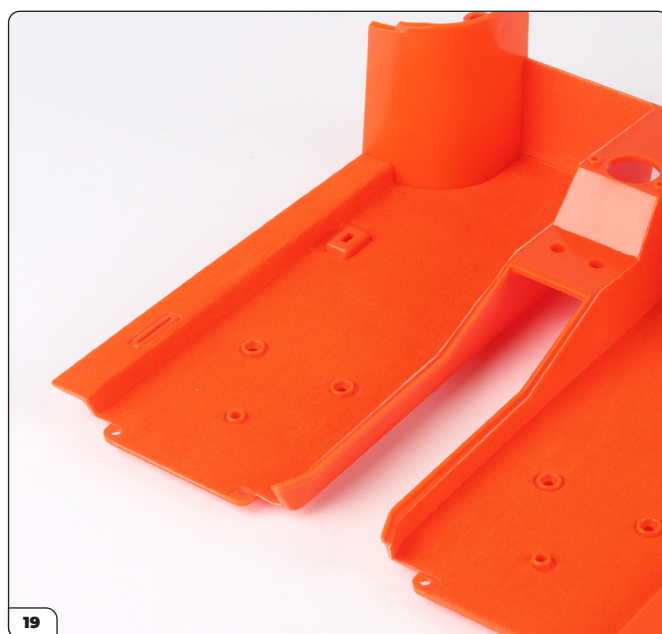

The sticker should look like this.

Stage 042: Adding Carpet to the Cockpit Floor

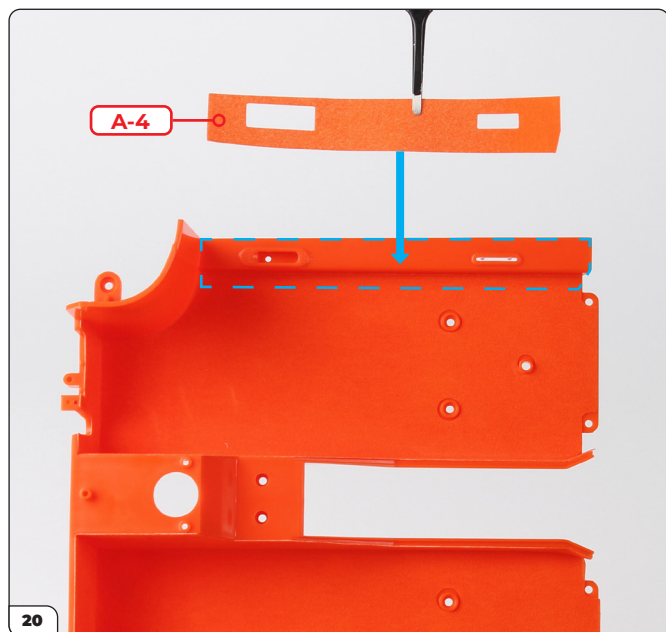

Remove sticker A-4 and align it with the right hand side as shown.



Press the sticker onto the right hand side, aligning the outside edges first (dashed line).

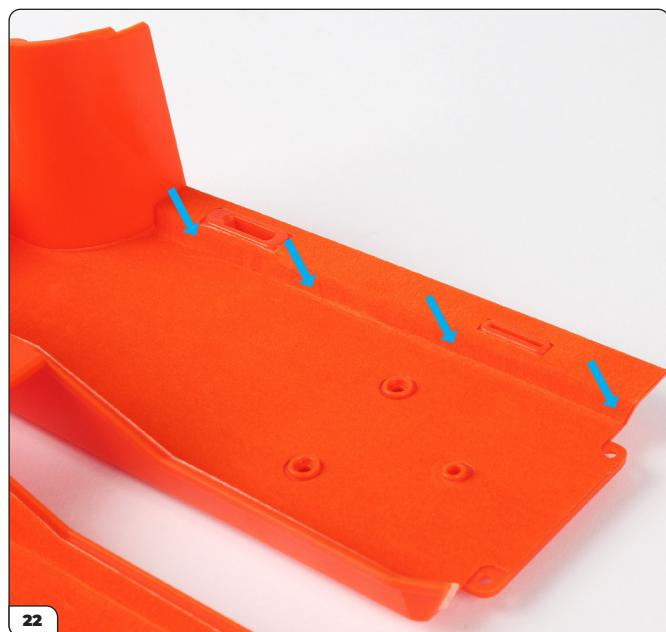

Fold and press the bottom edge down.

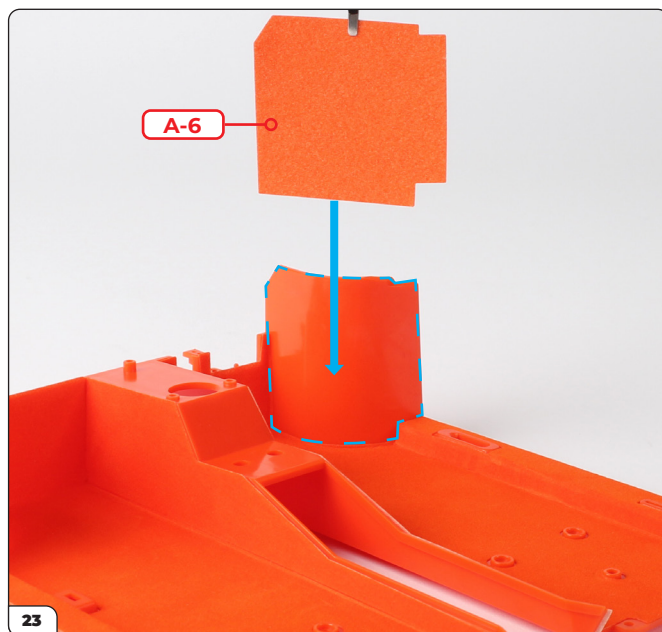

Remove sticker A-6 and align it with the right-hand side as shown.

Stage 042: Adding Carpet to the Cockpit Floor

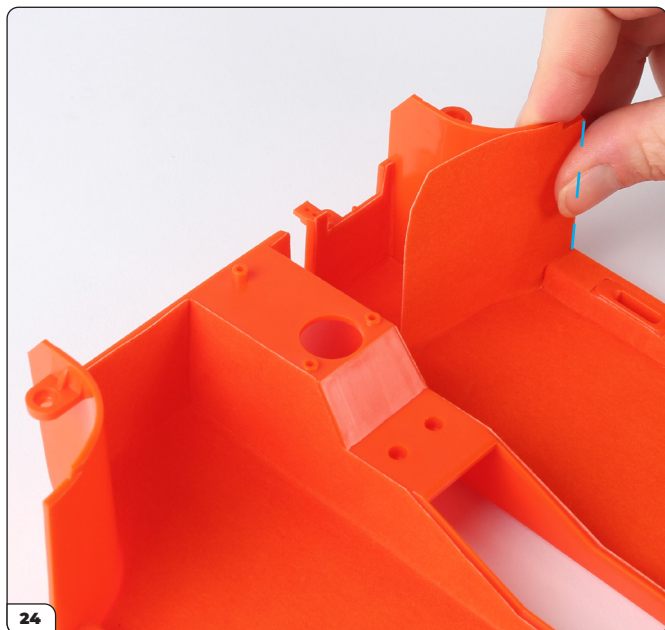

Press the sticker onto the right-hand side, aligning the outside edge first (dashed line).



Press the sticker around the curve while aligning the remaining edges.

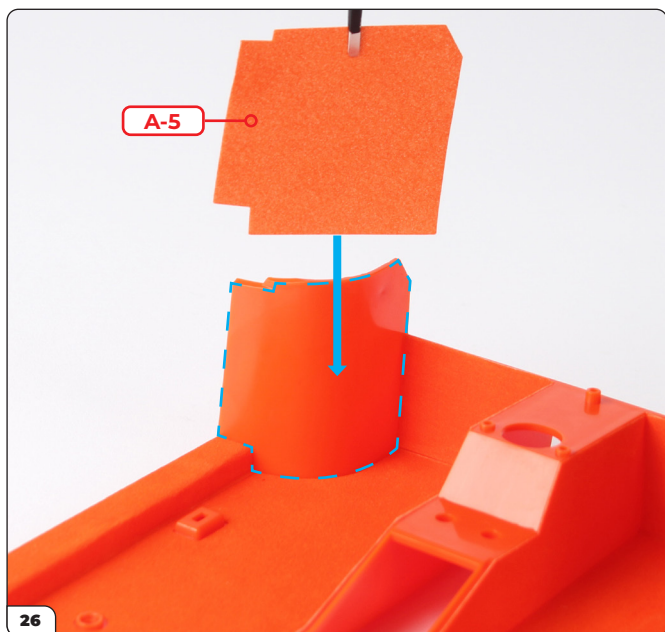

Remove sticker A-5 and align it with the left-hand side as shown.

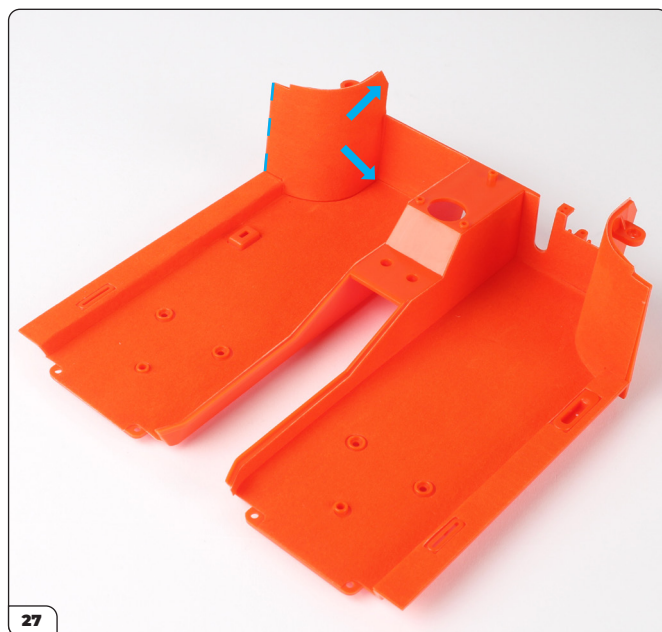

Press the sticker onto the left-hand side, aligning the outside edge first then pressing it around the curve.

Stage 042: Adding Carpet to the Cockpit Floor

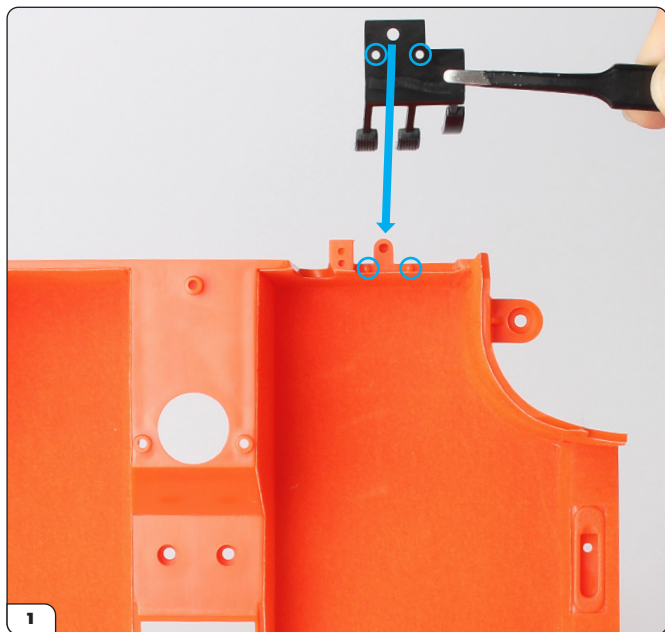

FITTING THE PEDALS, HANDBRAKE AND POWER SWITCH

Take the pedals (42-B) and align them with the fixing points in the driver's footwell.

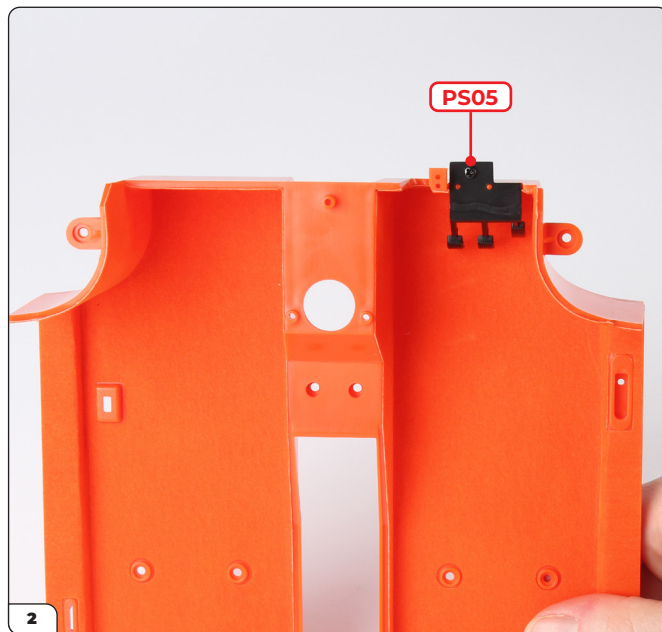

Press the pedals in place and secure with a PS05 screw.



Align the handbrake (42-C) with the rectangular hole on the right hand side.



Push in place.

Stage 042: Adding Carpet to the Cockpit Floor

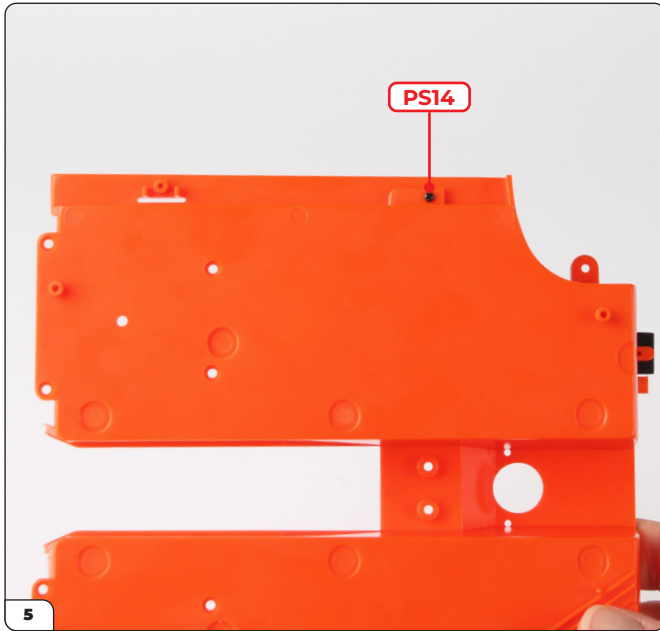

Secure from underneath with a PS14 screw.



Put the power switch cable No. 13 plug (42-F) through the bracket (42-E). Make sure the bracket is oriented as shown.

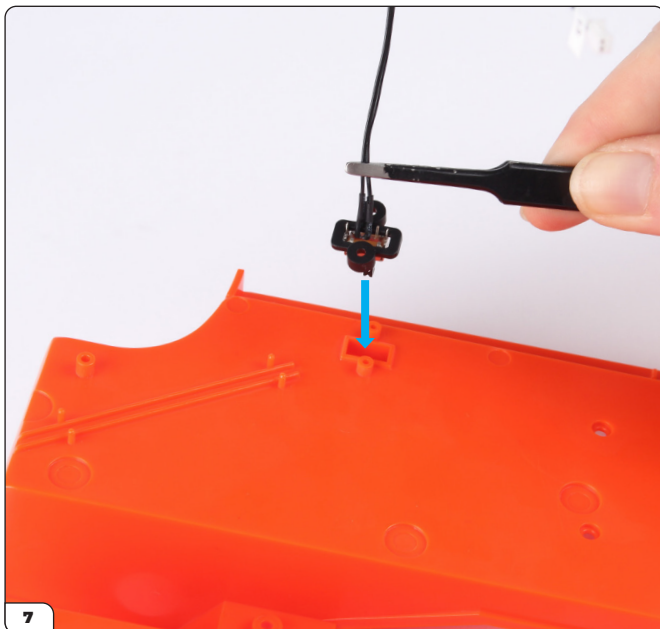

Move the bracket down the cable to the switch then push the switch into the rectangular opening on the bottom of the cockpit floor.

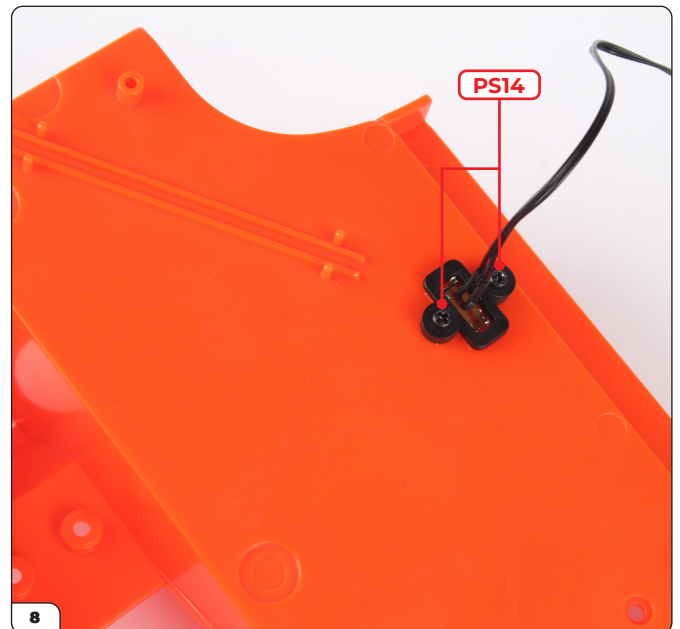

Secure the bracket to the floor using 2x PS14 screws.

Stage 042: Adding Carpet to the Cockpit Floor

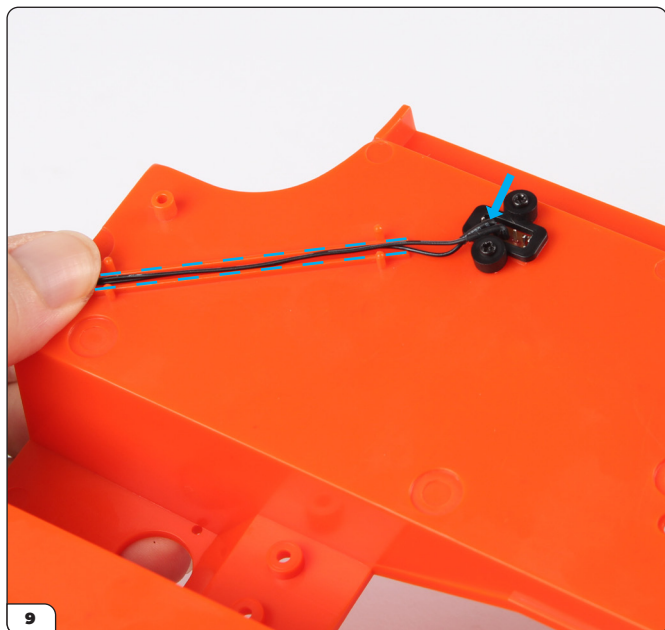

Carefully bend the cables (arrow) then place them in the channel (dashed lines).



Secure the cables by pressing the two cable brackets (42-D) in place.

