

**NO
TIME
TO
DIE** *007™*

DB5



Pack 12

BUILD INSTRUCTIONS

**STAGE 093: ATTACHING THE
REAR BUMPER**

**STAGE 097: BUILDING THE LEFT
HEADLIGHT AND MINIGUN**

**STAGE 094: ATTACHING THE
FRONT BUMPER**

**STAGE 098: INSTALLING THE LEFT
HEADLIGHT AND MINIGUN MECHANISM**

**STAGE 095: BUILDING THE RIGHT
HEADLIGHT AND MINIGUN**

**STAGE 099: BUILDING THE
REMOTE CONTROL**

**STAGE 096: INSTALLING THE RIGHT
HEADLIGHT AND MINIGUN MECHANISM**

**STAGE 100: ATTACHING THE CHASSIS
AND BODY**

NO TIME TO DIE © Danjaq, LLC and Metro-Goldwyn-Mayer Studios Inc. NO TIME TO DIE, *007™* and related James Bond Indicia © 1962-2024 Danjaq, LLC and Metro-Goldwyn-Mayer Studios Inc. NO TIME TO DIE, *007™* and related James Bond Trademarks are trademarks of Danjaq, LLC. All Rights Reserved.



Aston Martin, the Aston Martin Wings logo and the model name "DB5" are trademarks owned, licensed or used by Aston Martin Lagonda Limited. All Rights Reserved.

Advice from the experts

Spare screws are included with each part. Occasionally, you may be instructed to keep spare or unused screws for a later stage. Keep these spares in a safe place and label them correctly.

Please make sure you don't mix up the screws. They look quite similar, but the threads do vary slightly. Using the wrong screws may damage the parts.

When securing parts together using multiple screws, fit each screw loosely to ensure all the parts are correctly aligned before gently tightening them firmly, but not overtight, in the order in which you placed them.

The screwdriver can be magnetized by stroking it with a magnet (fridge magnet, etc.) enabling it to hold the screws and make assembly easier.

If a screw is tight going into a metal part, do not force it as you may shear the head off. Remove it and put a tiny smear of Vaseline, soap or light oil on the thread. That will lubricate it and make it easier to drive home.

During the course of this build, you will receive many pieces that you will assemble immediately – following the instructions in the corresponding stage – and other pieces that you should store safely to one side, for use in future assembly stages.

Left and Right! When building your *No Time To Die* Aston Martin DB5, the left- or right-hand side refers to that side as if you are sitting in the car.



WARNING: Some parts are assembled using magnets. These magnets can cause serious injury if they are swallowed. Keep away from children. If you suspect a magnet has been swallowed, seek medical help straight away.

Number Plate Options: LED or Non-LED

You have two options for the number plates on your model – the changing LED number plates or the non-LED versions. If you have chosen to fit the LED version in stage 092 you can continue to stage 093 on page 7.

If you have chosen the non-LED version, you can find the parts in Stage 100. Open the box and take the parts shown in the image below. Keep the other parts in the box safe until they are needed in Stage 100.

Follow the instructions over the next pages to install them. Keep the front number plate and front stickers until they are needed in stage 094.

NON-LED NUMBER PLATES PARTS LIST

Name
100-E Front number plate
100-F Rear number plate
100-G Number plate stickers



Attaching the Non-LED Rear Number Plate



Take the rear number plate light assembly (stage 089) and press it into the two upper holes in the boot lid (stage 091).



Secure from inside with 2x PS03 screws (from stage 092).



Push the rear number plate (100-F) into the boot lid. The pins are different sizes to ensure the correct orientation.



Align the circuit board mount (stage 092) with the inside of the boot lid. Press it onto the screw post and pin.

Attaching the Non-LED Rear Number Plate

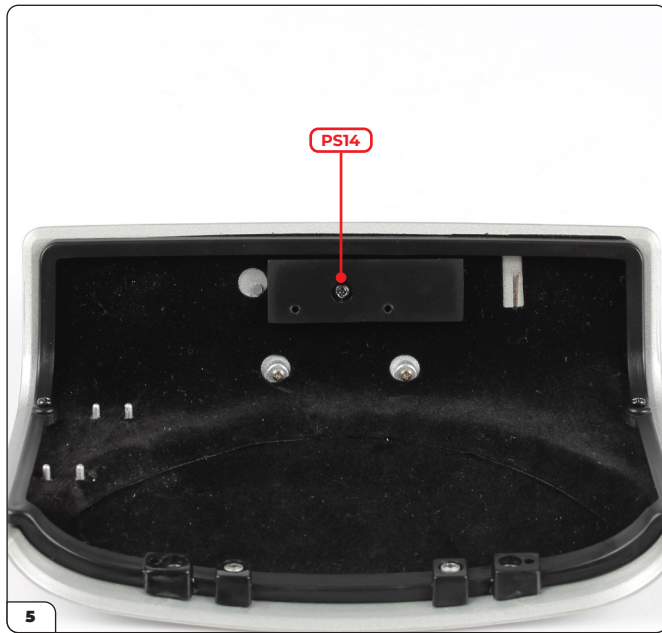

Screw the circuit board mount to the rear number plate with a PS14 screw (stage 092).

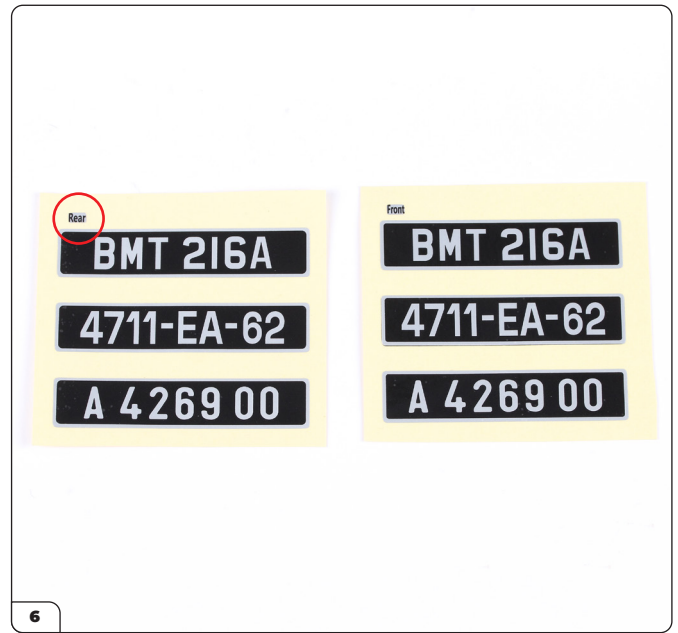

Take the number plate stickers (100-G). Choose one of the stickers to use from the sheet marked "Rear" (circled).



Peel the sticker off the sheet and apply it to the rear number plate.



The rear number plate has been installed.

Attaching the Non-LED Rear Number Plate

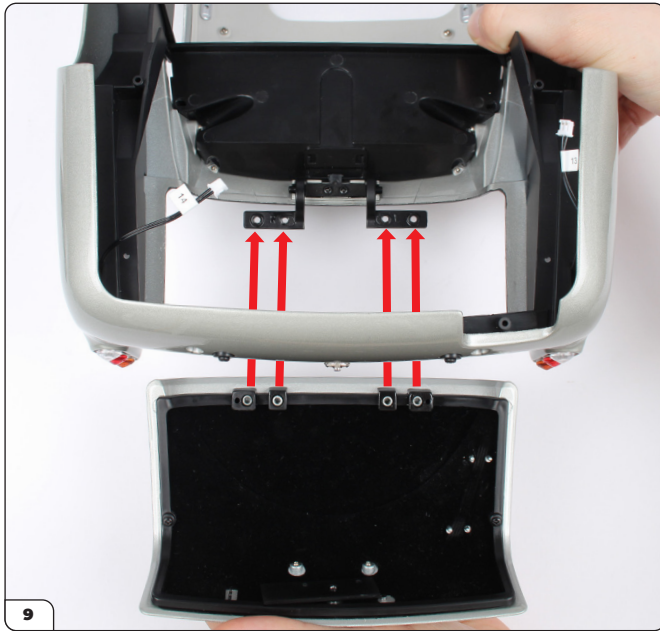

Place the main body upside down on your work surface then align the boot lid with the hinges.

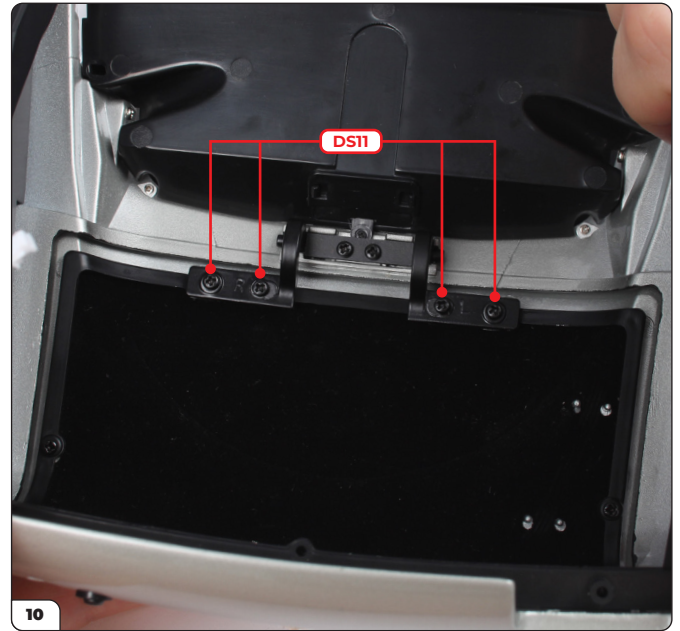

Position the boot lid against the body and screw it to the hinges using 4x DS11 screws (stage 092).



Stage 093: Attaching the Rear Bumper

In this stage you will attach the rear bumper.



STAGE 093 PARTS LIST

Name
93-A Rear bumper
93-B Left overrider
93-C Right overrider
93-D Rear bumper reflector x2
PS01 screws x5
PS20 screws x3



Stage 093: Attaching the Rear Bumper



Push one of the rear bumper reflectors (93-D) into the rear bumper (93-A). The reflector is shaped so it will only go in one way.

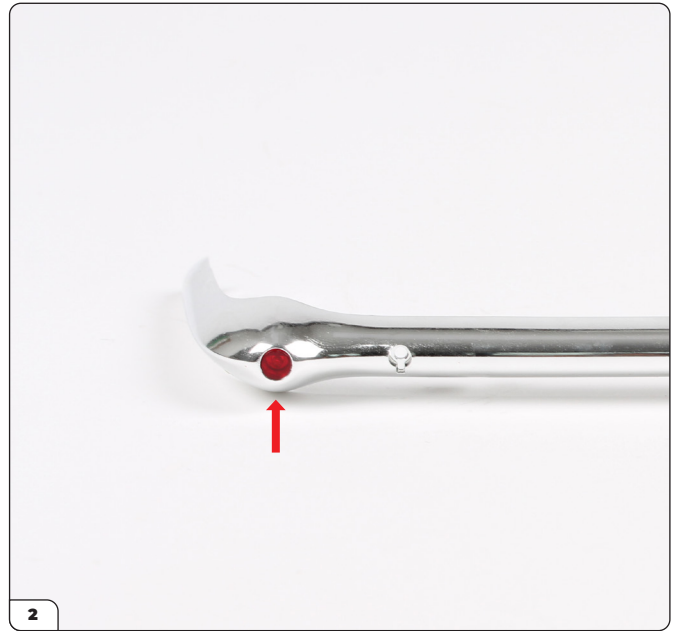

Push the second rear bumper reflector into the other side.



Screw the reflectors to the rear bumper with 2x PS01 screws.

Stage 093: Attaching the Rear Bumper

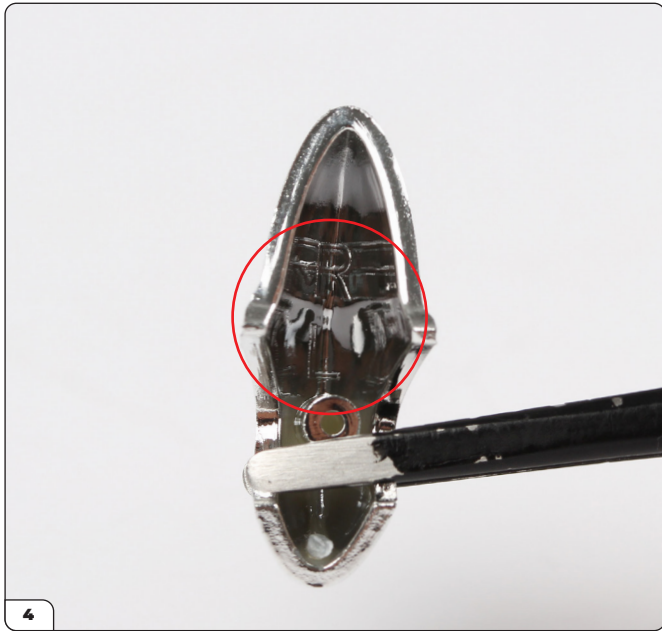

Take the rear left overrider (93-B). It has "R L" marked on the inside (circled).

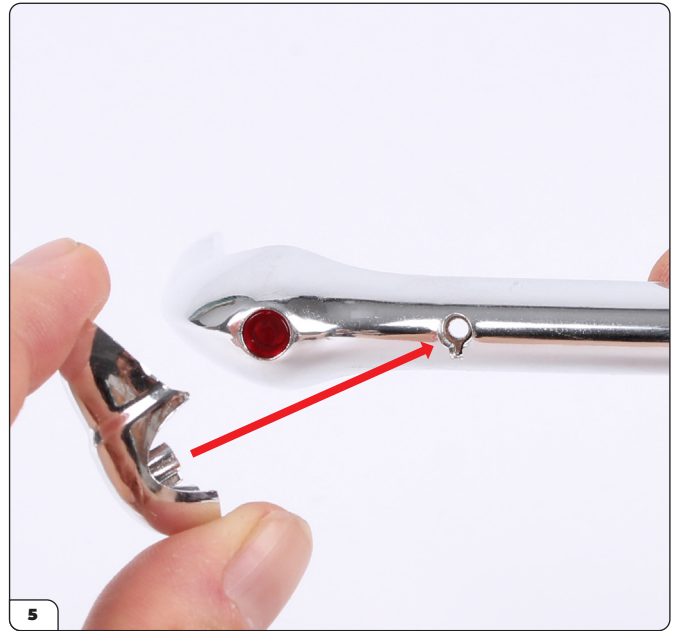

Push the rear left overrider into the rear bumper.



Make sure the rear left overrider is place on the left side.



Screw the overrider to the bumper with a PS01 screw.

Stage 093: Attaching the Rear Bumper

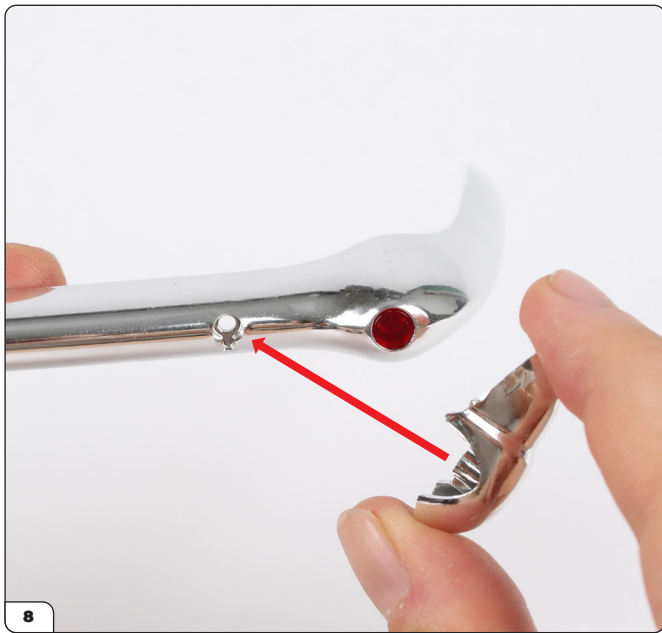

Take the rear right overrider (93-C) marked with "R R". Push it into the rear bumper.



Screw the overrider to the bumper with a PS01 screw.



Push the rear bumper into the body assembly.

Stage 093: Attaching the Rear Bumper

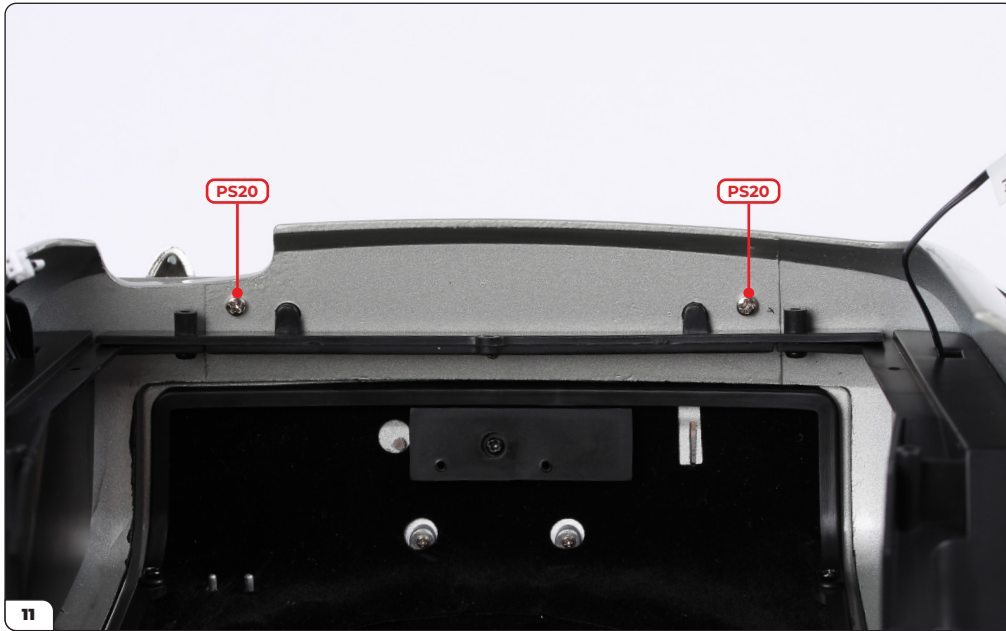

Screw the rear bumper to the body with 2x PS20 screws.



Stage 094: Attaching the Front Bumper

In this stage you will attach the front number plate and bumper. If you are using the non-LED number plates, you will need the parts from stage 100.



STAGE 094 PARTS LIST

Name	Name
94-A Front bumper	94-F Circuit board
94-B Left overrider	94-G Front number plate screen
94-C Right overrider	PS01 screws x6
94-D Front number plate frame back	PS06 screws x3
94-E Front number plate frame front	PS20 screws x3

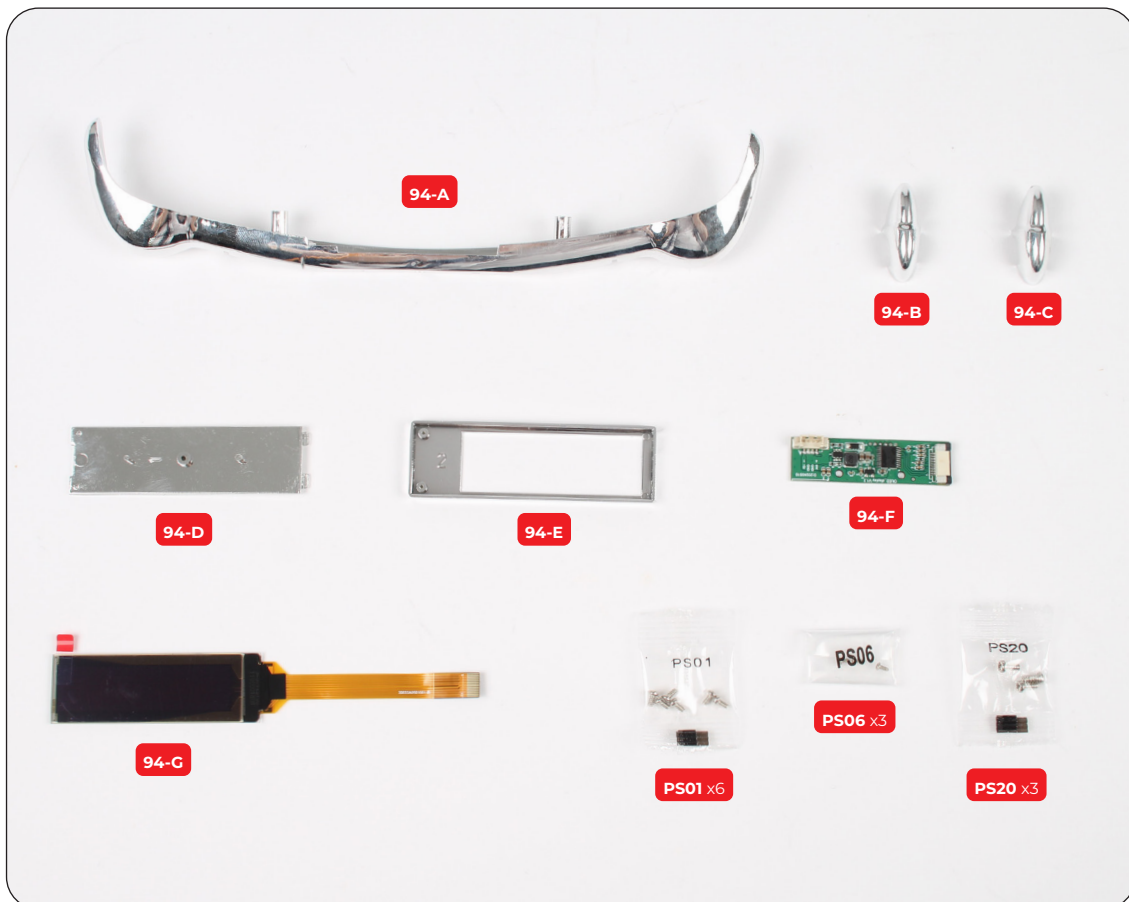

Stage 094: Attaching the Front Bumper

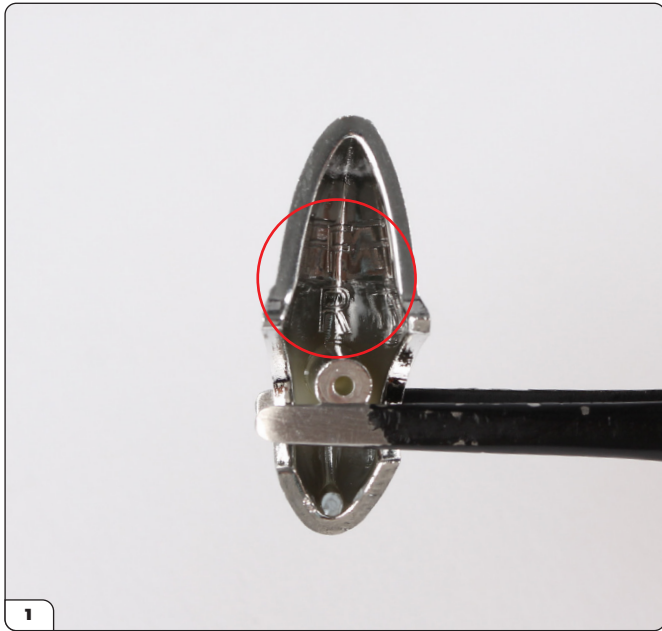

Building the Front Bumper

Take the front right overrider (94-C). It has "F R" marked on the inside (circled).



Push the front right overrider into the front bumper (94-A). Make sure you are placing it on the correct side.



Screw the overrider to the front bumper with a PS01 screw.

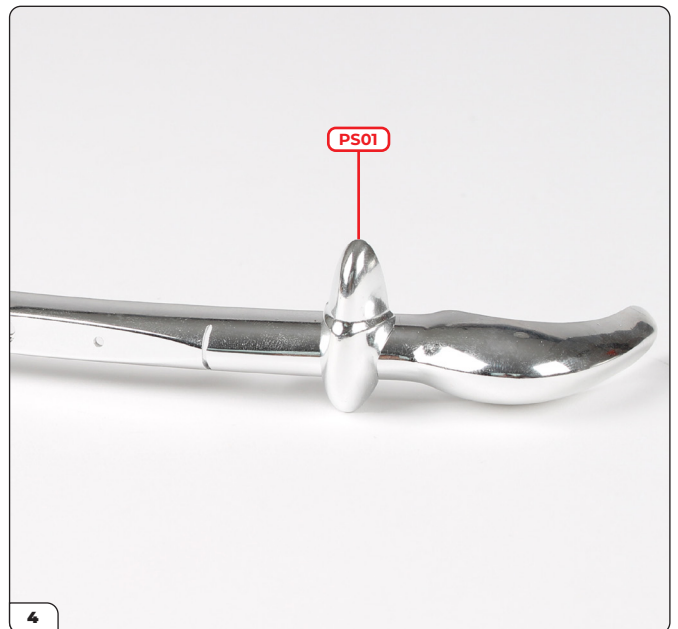

Push the front left overrider (94-B), marked "F L", into the front bumper and screw it in place with a PS01 screw.

Stage 094: Attaching the Front Bumper

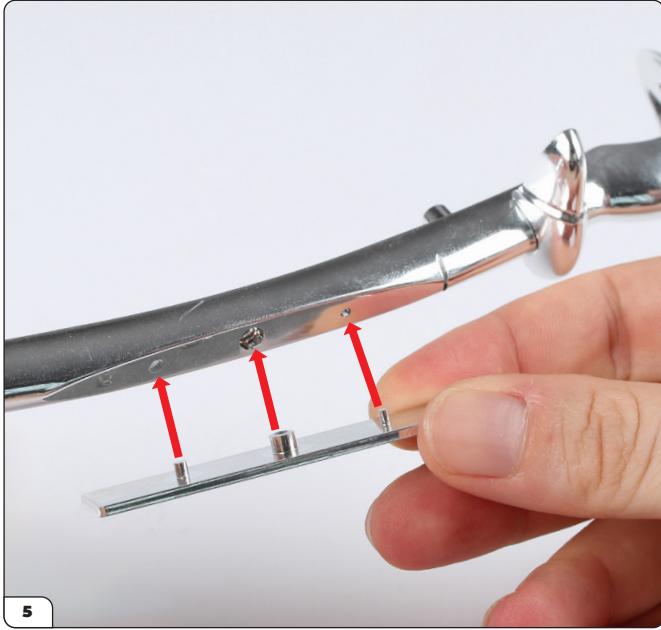

Fitting the Non-LED Front Number Plate

Take the front number plate (100-E) and push it into the front bumper.

If you are using the LED number plates, go to step 11 on page 16.

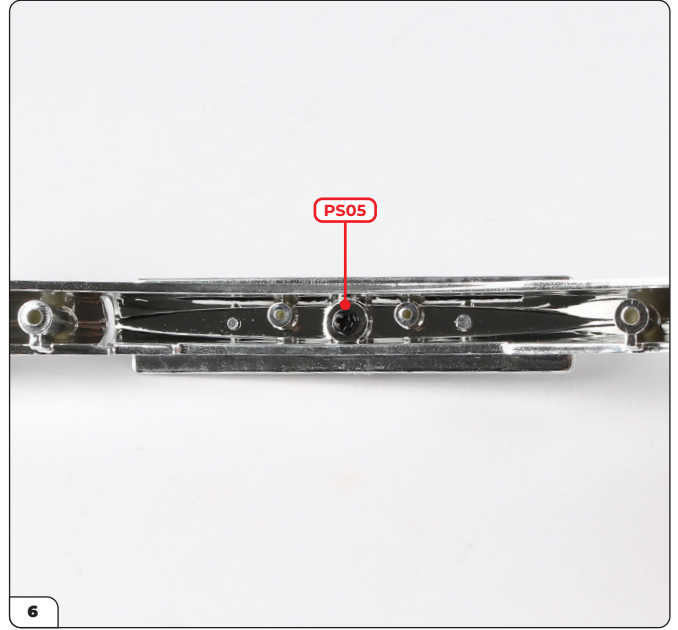

Screw the front number plate to the front bumper with a PS05 screw.

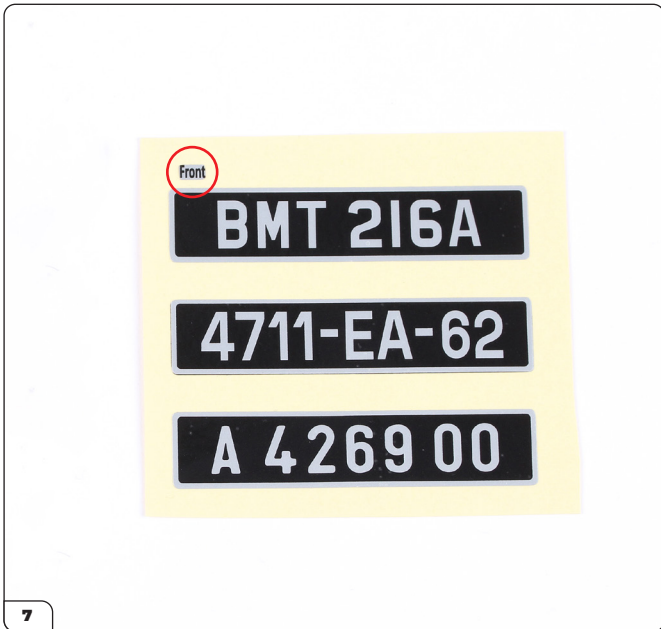

Take the number plate stickers (100-G). Choose one of the stickers to use from the sheet marked "Front" (circled).



Peel the sticker off the sheet and apply it to the front number plate.

Stage 094: Attaching the Front Bumper

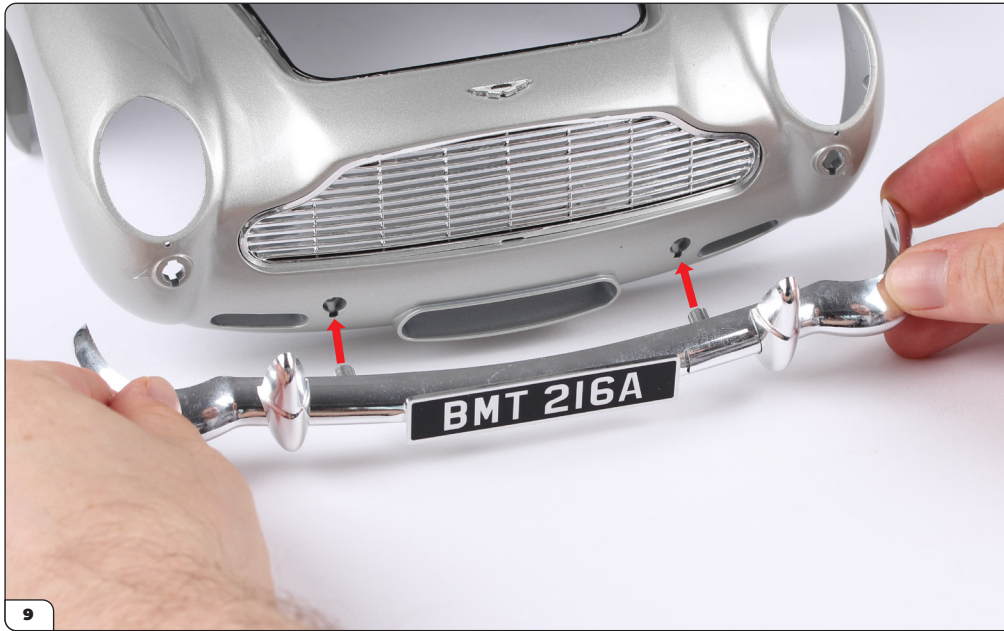

Push the front bumper into the main body.

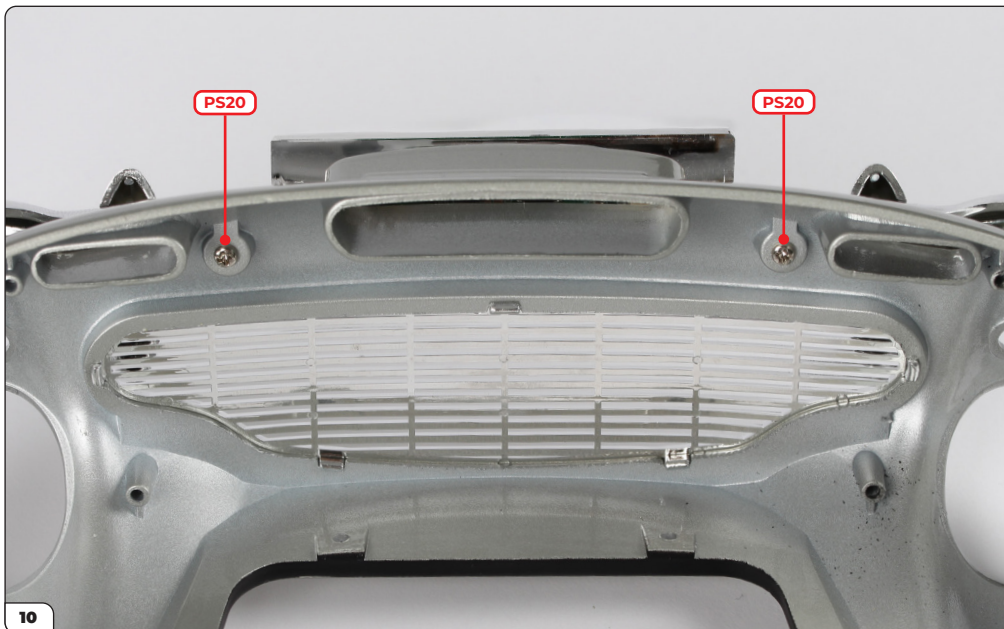

Screw the front bumper to the body with 2x PS20 screws. You can now continue to stage 095.

Stage 094: Attaching the Front Bumper

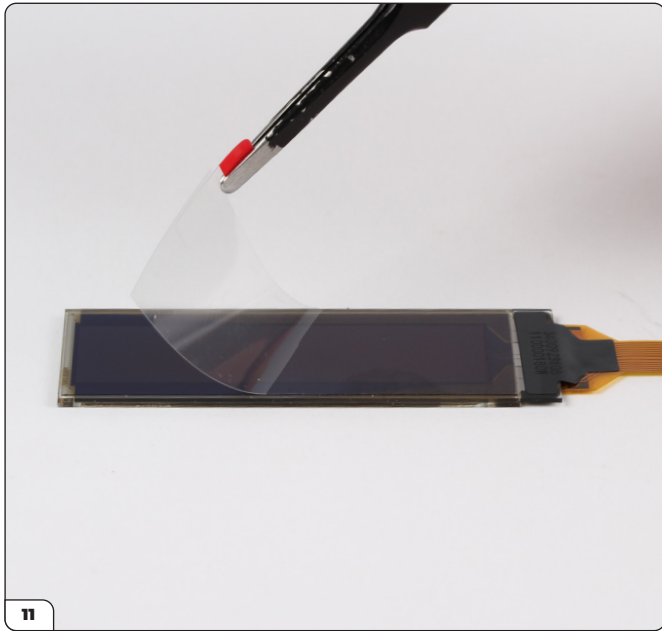

Fitting the LED Front Number Plate

Take the front number plate screen (94-G) and peel the protective film from it.

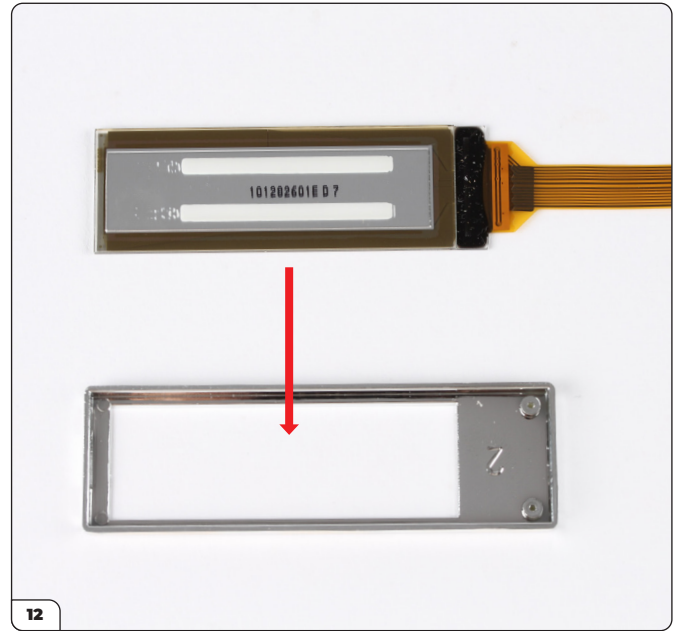

Align the screen with the front number plate frame front (94-E) as shown.

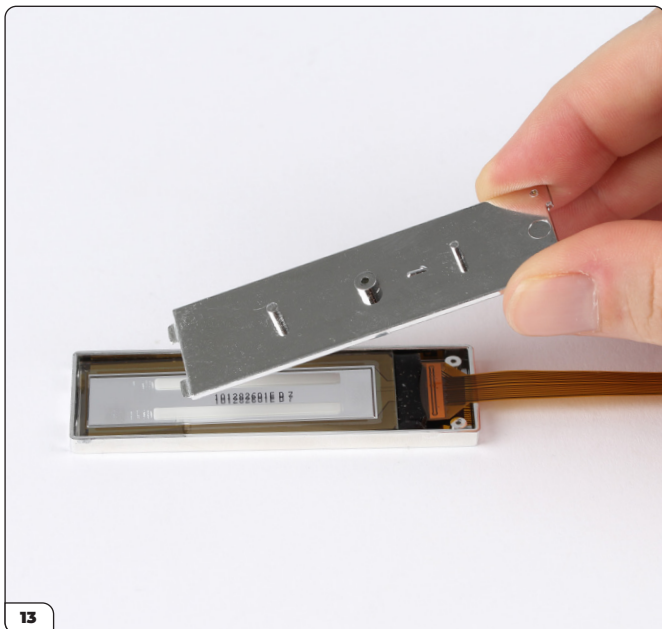

Place the screen into the frame, then align the frame back (94-D) with the assembly.



Fit the back in place. You may need to adjust the position of the screen slightly to allow the front and back to fit together.

Stage 094: Attaching the Front Bumper

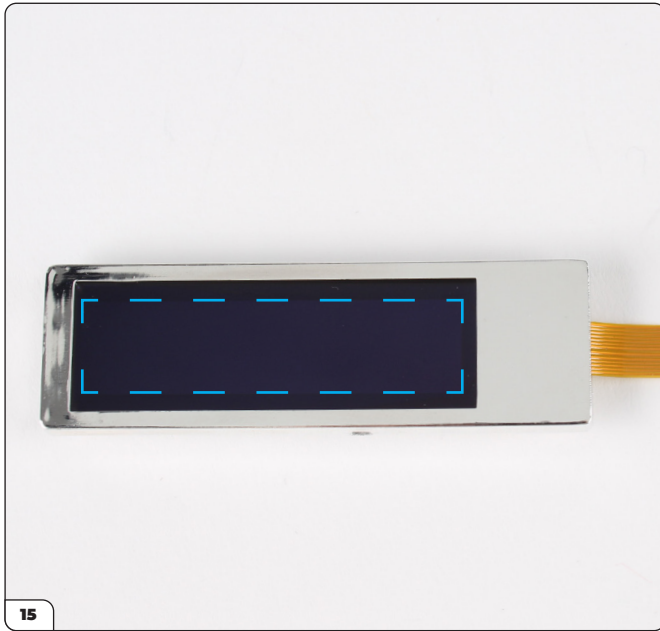

Turn the number plate over and check the screen is centred (dashed line). Carefully adjust the position by sliding the screen if needed.

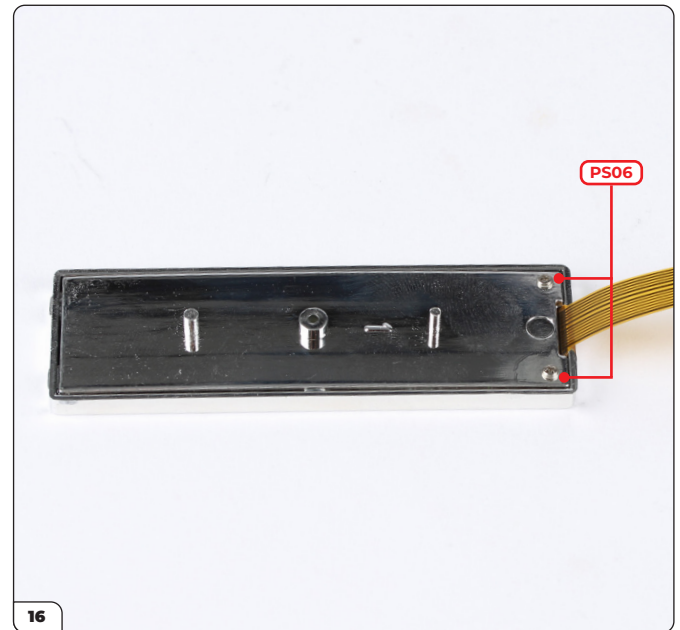

Secure the front and back together using 2x PS06 screws.

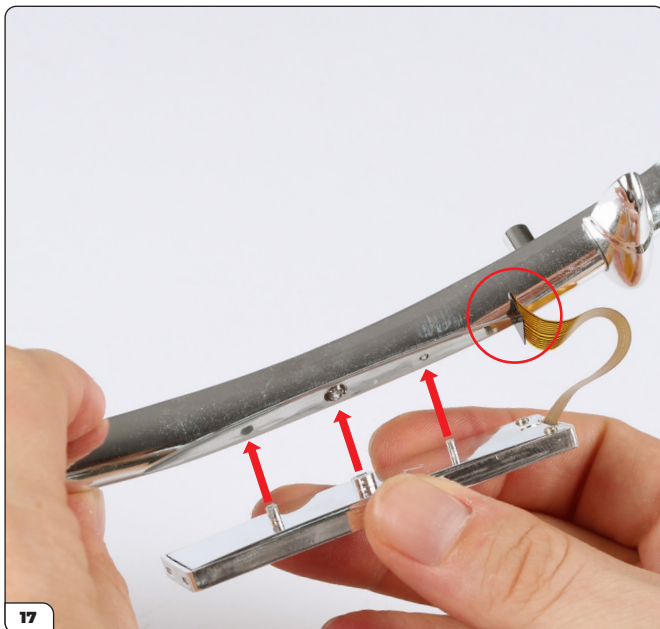

Push the screen ribbon cable through the opening in the front bumper (circled) then push the front number plate into the holes (arrows).

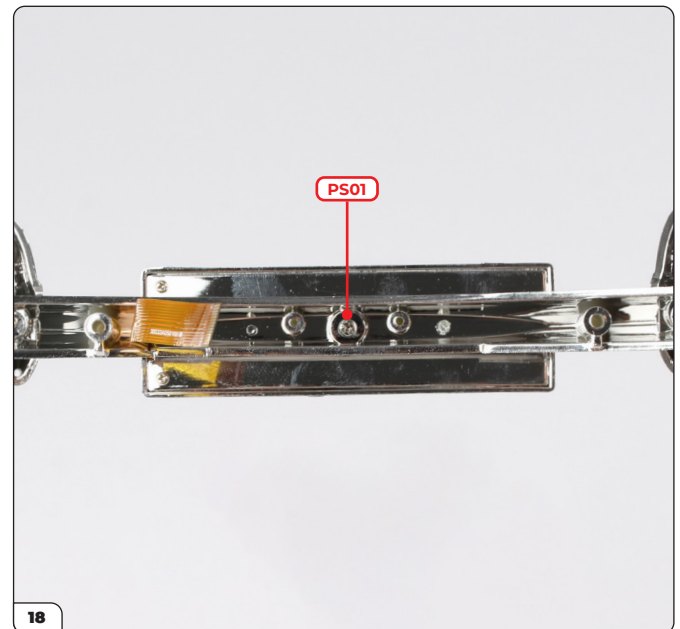

Screw the front number plate to the front bumper with a PS01 screw.

Stage 094: Attaching the Front Bumper

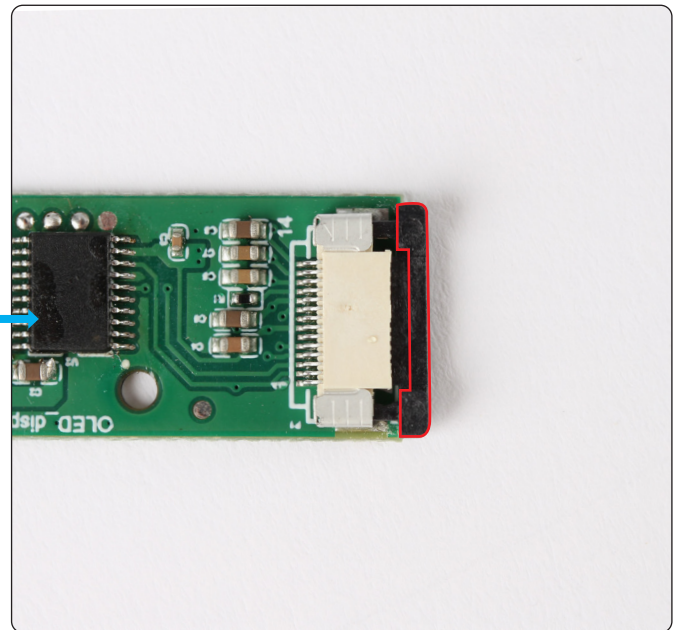
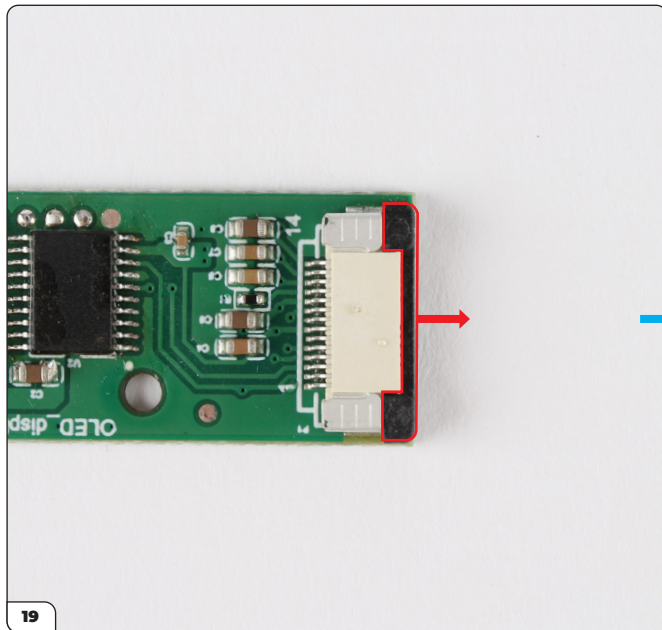

Take the circuit board (94-F) and unlock the socket by sliding the black section out as shown.

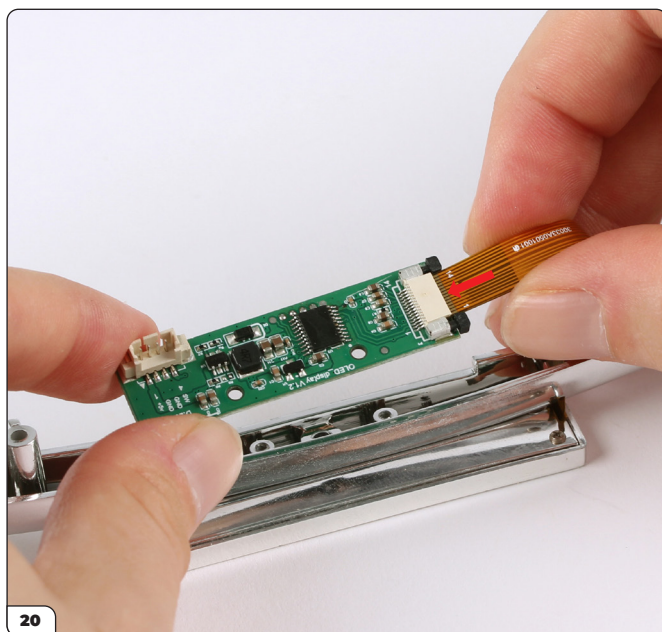

Plug the ribbon cable into the circuit board.

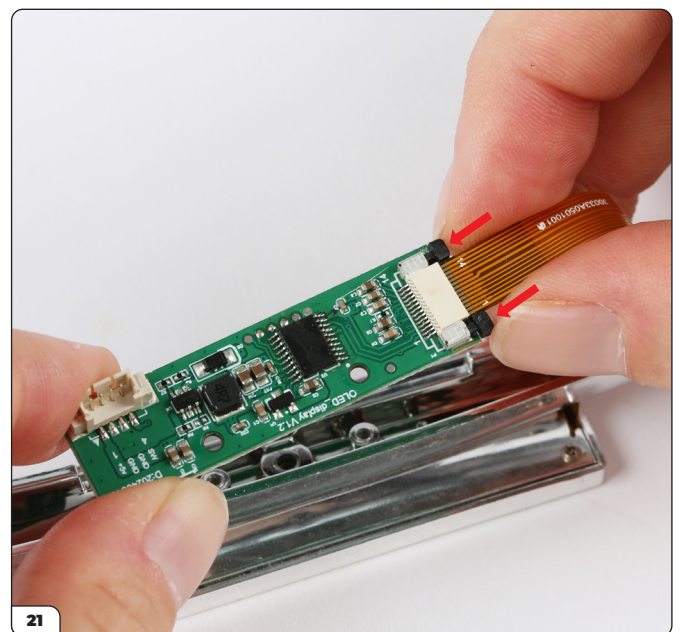

Lock the socket by pushing the black section back in.

Stage 094: Attaching the Front Bumper

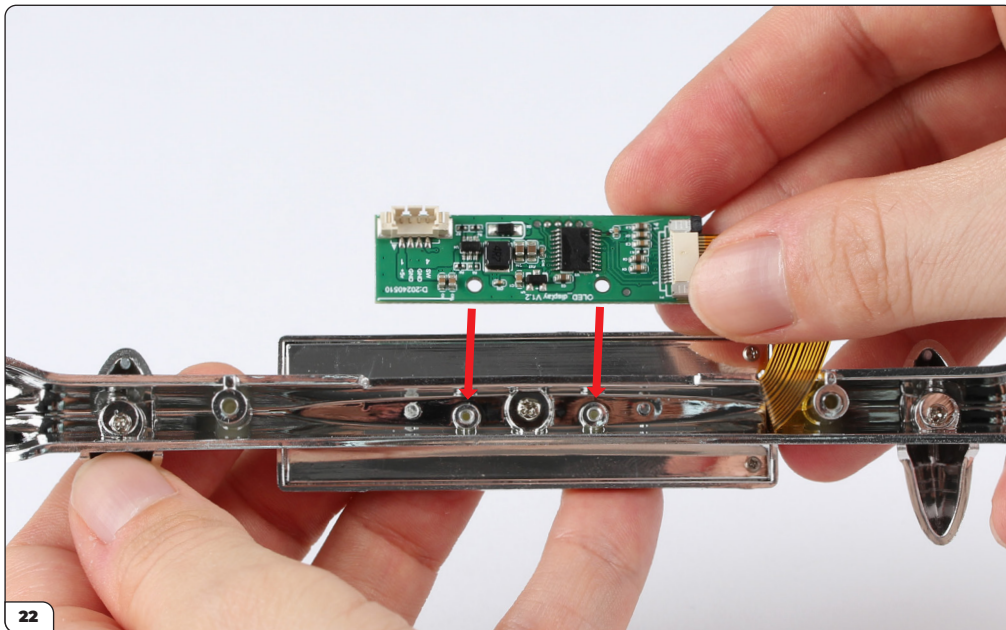

Place the circuit board onto the front bumper.

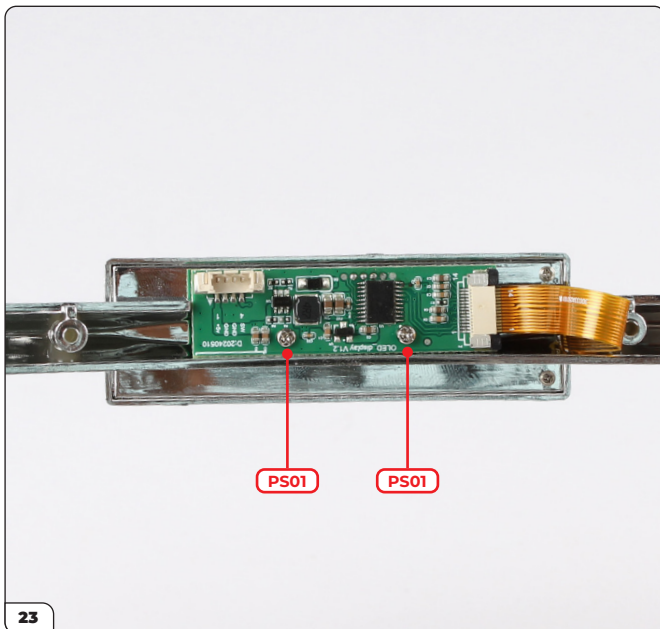

Screw the circuit board to the front bumper with 2x PS01 screws.

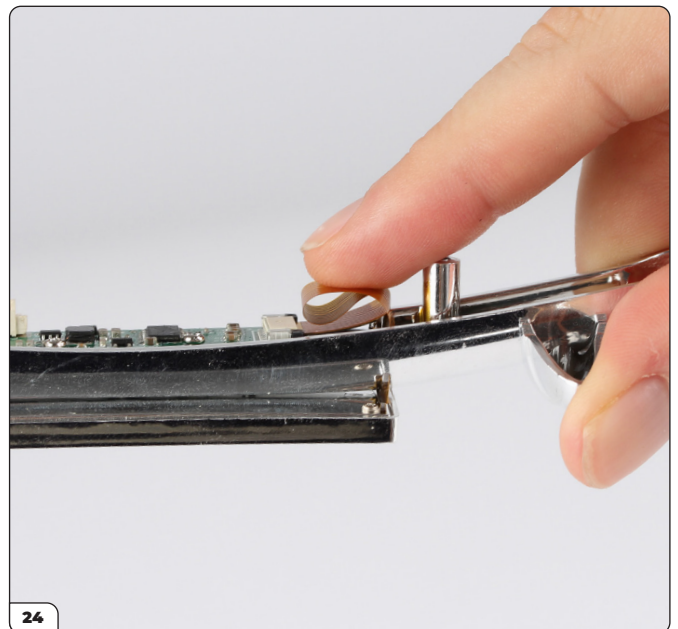

Fold the ribbon cable and tuck it into the front bumper.

Stage 094: Attaching the Front Bumper



Push the front bumper into the main body (stage 93).

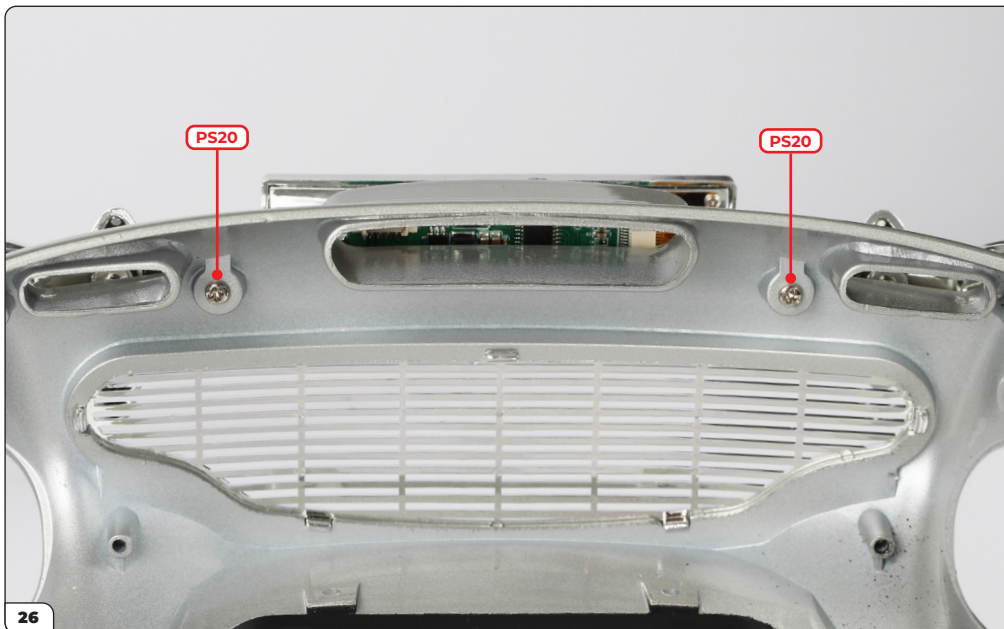

Screw the front bumper to the body with 2x PS20 screws.

Stage 094: Attaching the Front Bumper

STAGE COMPLETE



Stage 095: Building the Right Headlight and Minigun

In this stage you'll build the right headlight and the M134 minigun



STAGE 095 PARTS LIST

Name	Name
95-A Headlight housing (R)	95-H M134 barrel clamp
95-B Headlight reflector	95-I M134 muzzles
95-C Headlight glass	95-J M134 barrel cluster
95-D Headlight cover	95-K Light rod x6
95-E Headlight bezel	95-L Headlight LED '03'
95-F Foglight lens	PS21 screws x3
95-G Foglight mount	DS41 screws x2



Stage 095: Building the Right Headlight and Minigun



Press the headlight glass (95-C) into the reflector (95-B). There is a small tab which goes into a small recess (arrow).

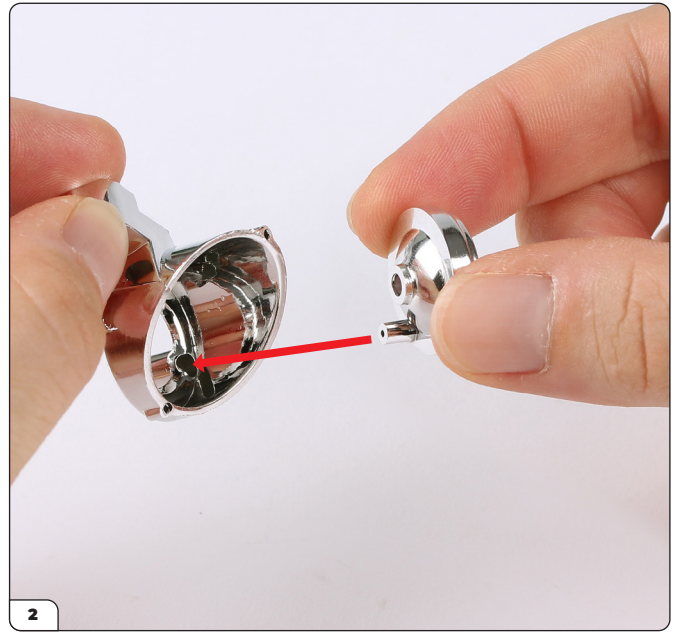

Push the reflector into the headlight housing (95-A).



Screw the parts together with a PS21 screw.

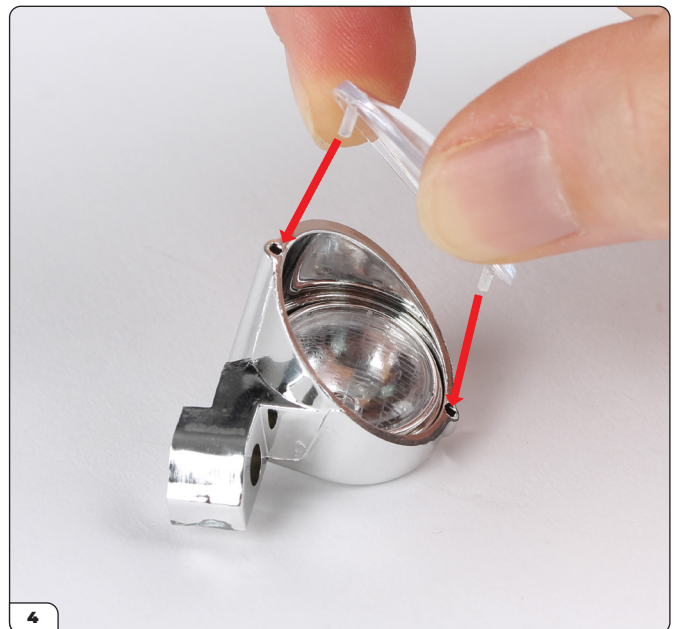

Press the headlight cover (95-D) into the headlight housing. You may need to remove excess paint from the holes.

Stage 095: Building the Right Headlight and Minigun



Gently push the headlight LED (95-L) into the headlight housing.

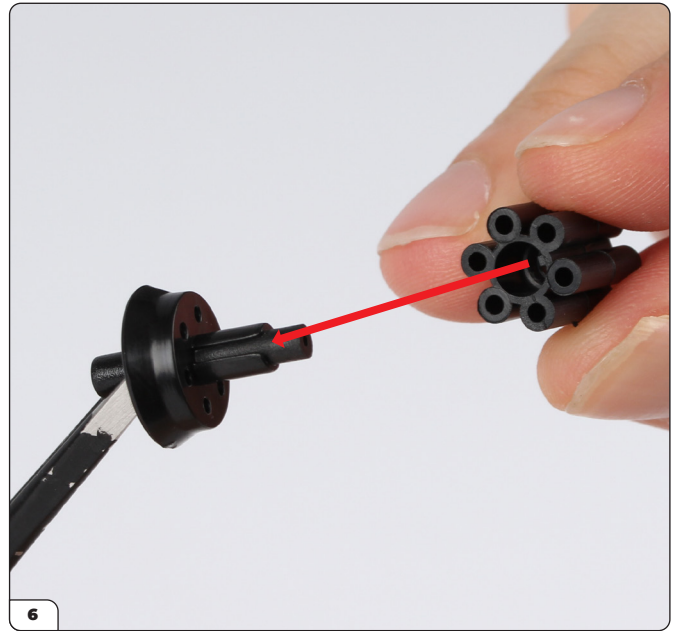

Push the barrel cluster (95-J) onto the barrel clamp (95-H). There is a recess on the barrel clamp so it only fits in one way.



Push the muzzles (95-I) into the barrel cluster. This part also has a recess so can only fit in one way.



Screw the parts together with a PS21 screw.

Stage 095: Building the Right Headlight and Minigun

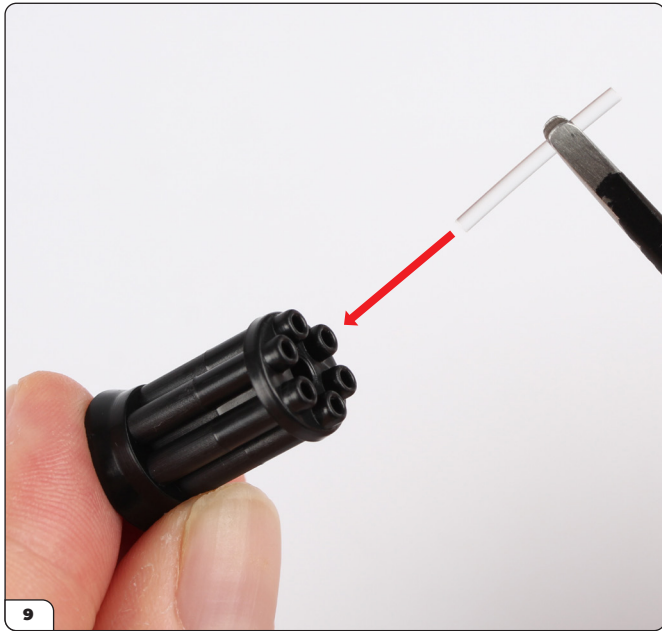

Take one of the light rods (95-K) and push it into a barrel.

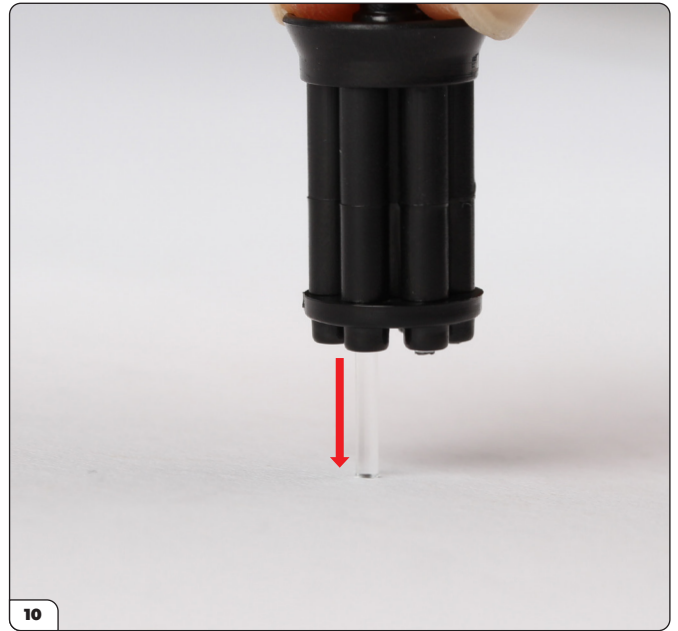

Take another light rod and press it into another barrel. You may find it easier to push the light rods in by pressing down on the table as shown.



Continue until all six light rods have been inserted into the barrels.

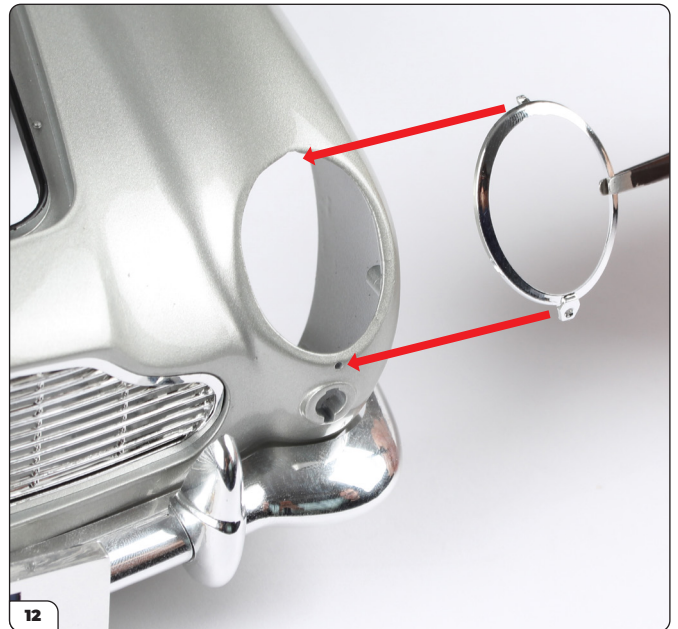

Place the headlight bezel onto the main body.

Stage 095: Building the Right Headlight and Minigun



Screw the bezel to the main body with a DS41 screw. Be very careful your screwdriver doesn't slip and scratch the paintwork!

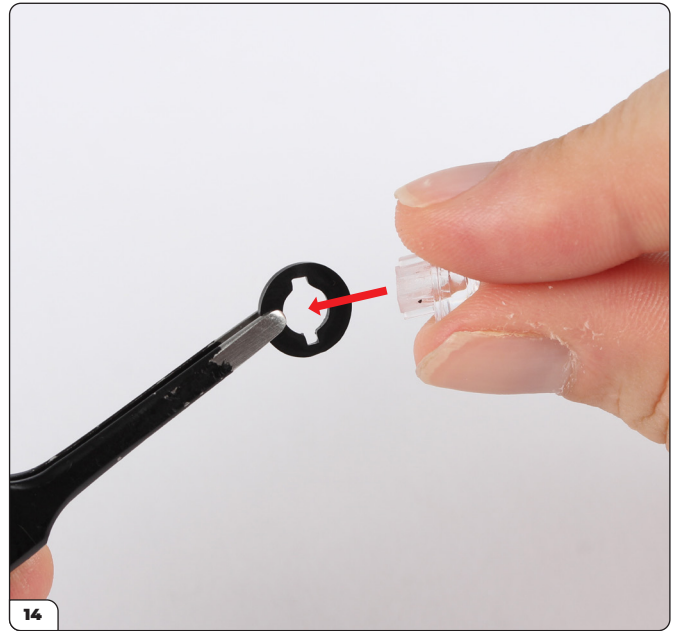

Push the foglight lens (95-F) into the foglight mount (95-G).

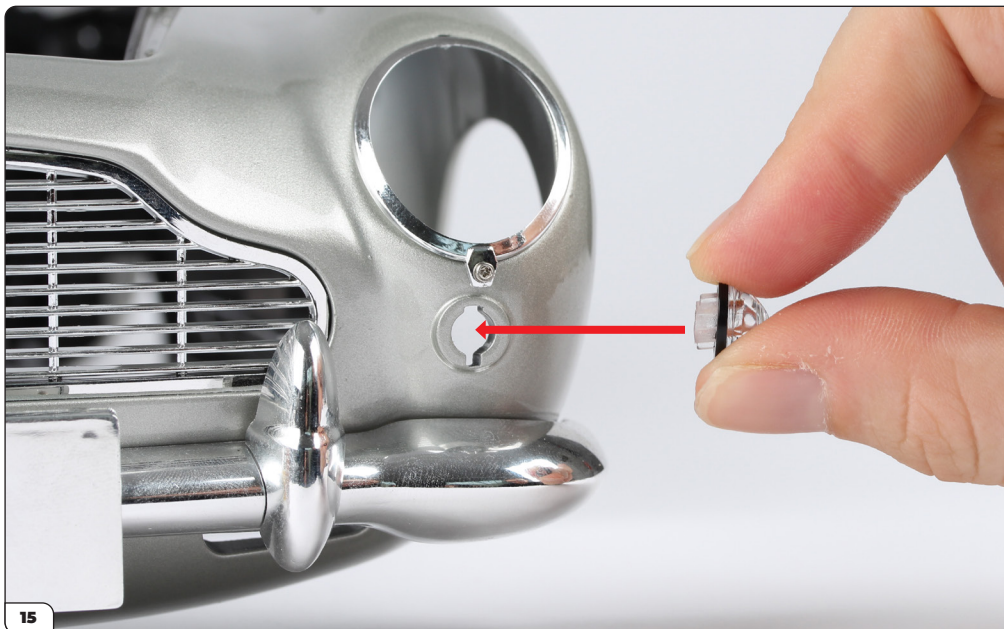

Push the foglight into the main body.

Stage 095: Building the Right Headlight and Minigun

STAGE COMPLETE



Stage 096: Installing the Right Headlight and Minigun Mechanism

In this stage you'll build and install the mechanism that operates the right headlight and minigun.



STAGE 096 PARTS LIST

Name	Name
96-A Mechanism part 1	96-J Short spring
96-B Mechanism part 2	96-K Long spring
96-C Mechanism part 3	96-L Motor with wires '05'
96-D Minigun stopper	96-M Muzzle flash LED '07'
96-E Minigun stopper bracket	DS02 screws x6
96-F Headlight stopper	DS03 screws x2
96-G Cap	PS05 screws x5
96-H Clamp x2	PS17 screws x2
96-I Shaft	DS28 screws x3



Stage 096: Installing the Right Headlight and Minigun Mechanism

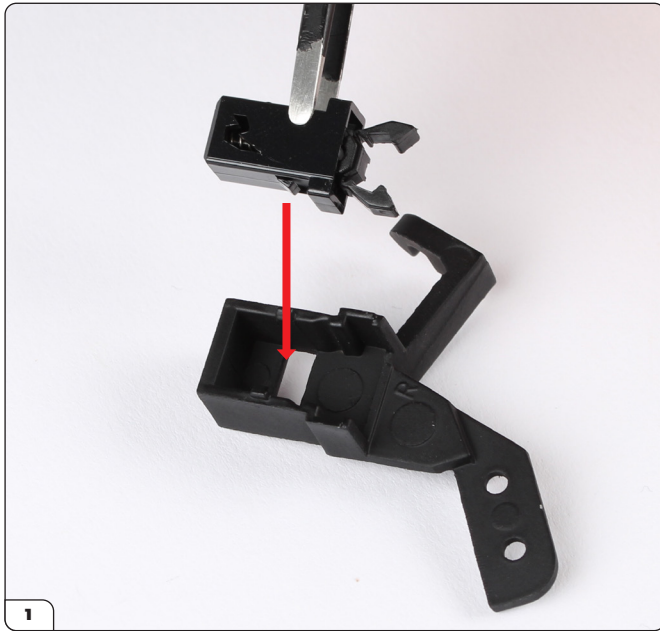

Assembling the Headlight Minigun Mechanism
Press one of the clamps (96-H) into the mechanism part 2 (96-B).



Press the other clamp into the mechanism part 1 (96-A).

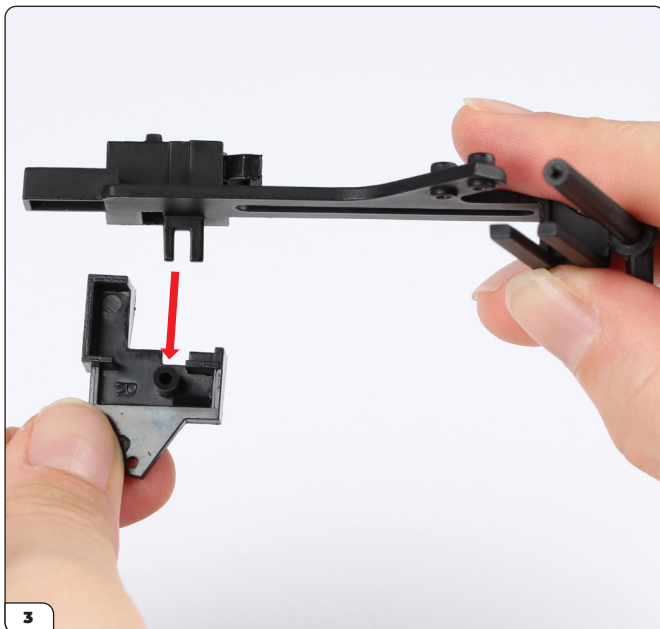

Push mechanism part 1 into mechanism part 3 (96-C) in the orientation shown.

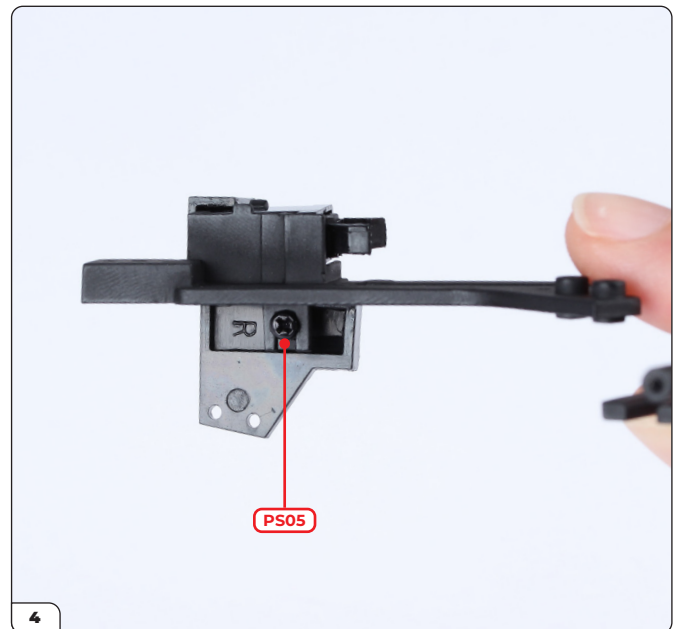

Screw the parts together with a PS05 screw.

Stage 096: Installing the Right Headlight and Minigun Mechanism

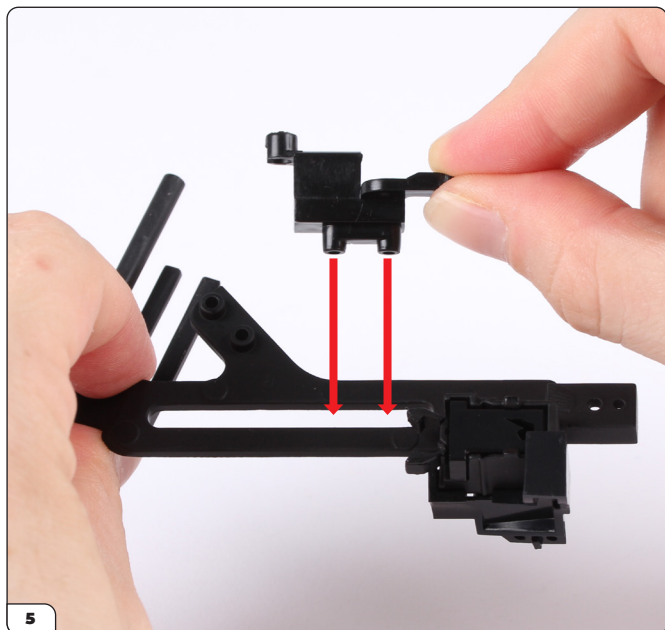

Place the minigun stopper (96-D) into the rail on part 1 in the orientation shown.



The minigun stopper will align with the clamp when pushed back along the rail.

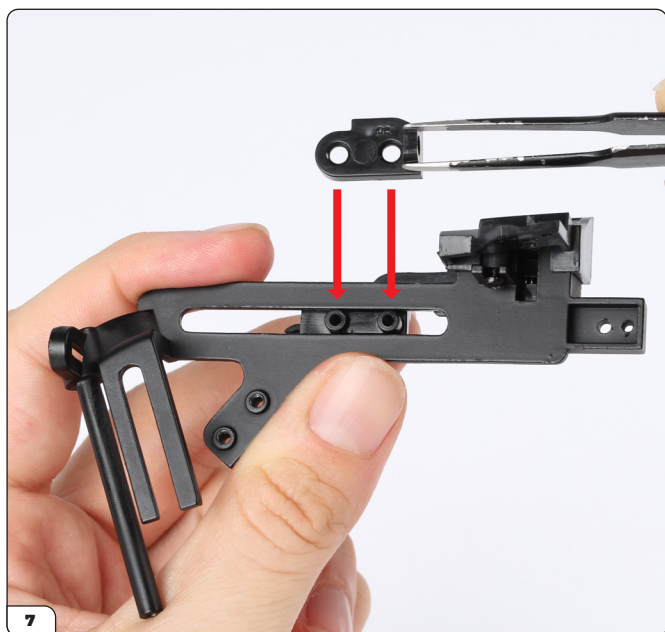

Hold the minigun stopper in place and turn the assembly over. Place the minigun stopper bracket (96-E) over the screw holes in the orientation shown.



Screw the parts together with 2x PS05 screws.

Stage 096: Installing the Right Headlight and Minigun Mechanism

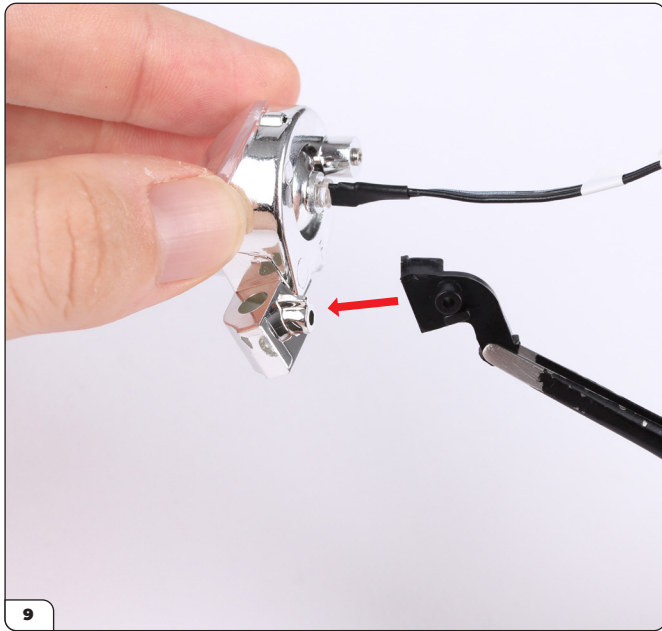

Push the headlight stopper (96-F) onto the right headlight housing (stage 095).



Screw the parts together with a PS05 screw.



Place the long spring (96-K) onto the shaft (96-I).



Push the shaft into the minigun stopper bracket.

Stage 096: Installing the Right Headlight and Minigun Mechanism



Push the other end of the shaft into the recess.

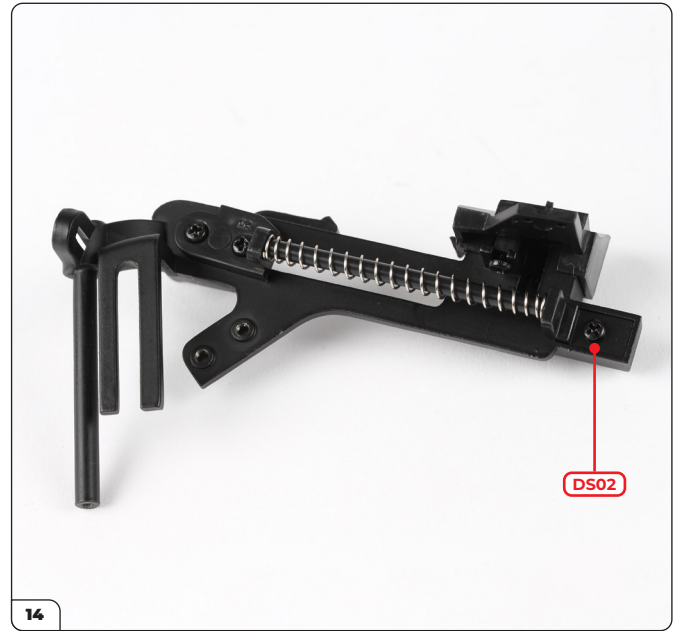

Screw the shaft to part 1 using a DS02 screw.

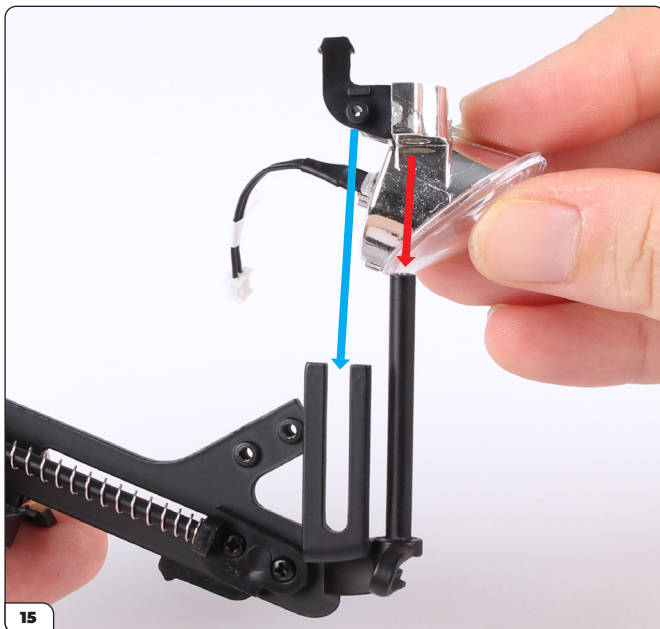

Push the right headlight housing onto part 1, fitting the headlight stopper between the rails as shown by the blue arrow.



The assembly should now look like this.

Stage 096: Installing the Right Headlight and Minigun Mechanism

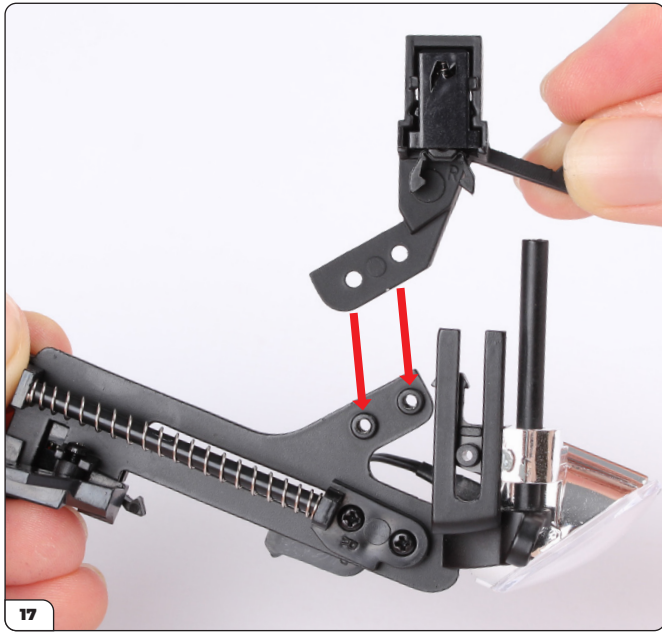

Take mechanism part 2 (from step 1) and place it over the two screw holes.

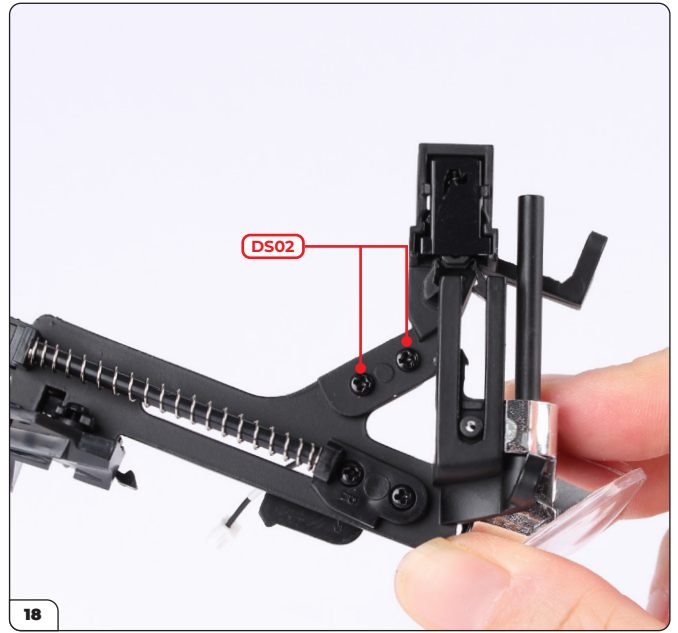

Screw the parts together with 2x DS02 screws.



Screw the headlight stopper with a PS17 screw. Don't overtighten as the part should be able to slide up and down the rail.



Place the short spring (96-J) onto the headlight shaft.

Stage 096: Installing the Right Headlight and Minigun Mechanism

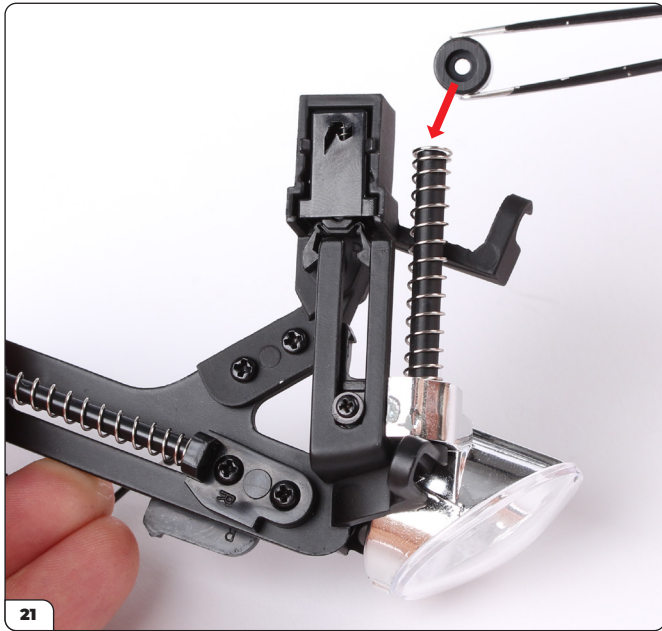

Push the cap (96-G) over the end of the shaft.

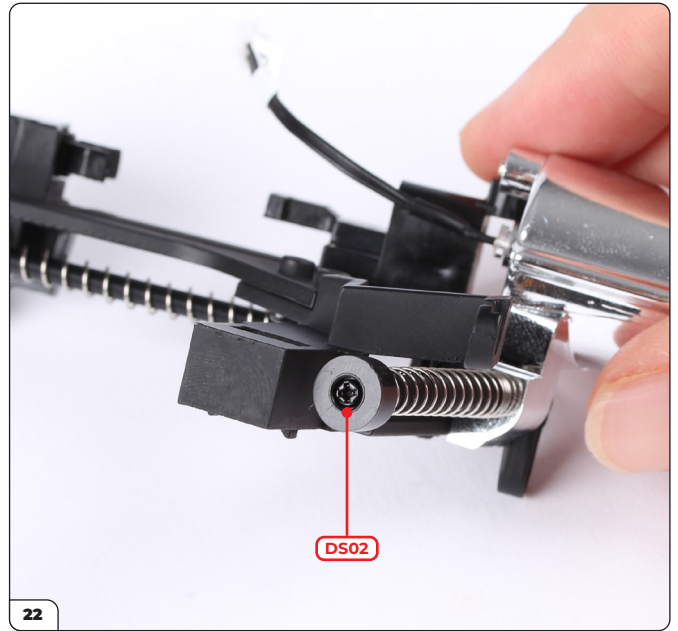

Screw the cap to the shaft with a DS02 screw.

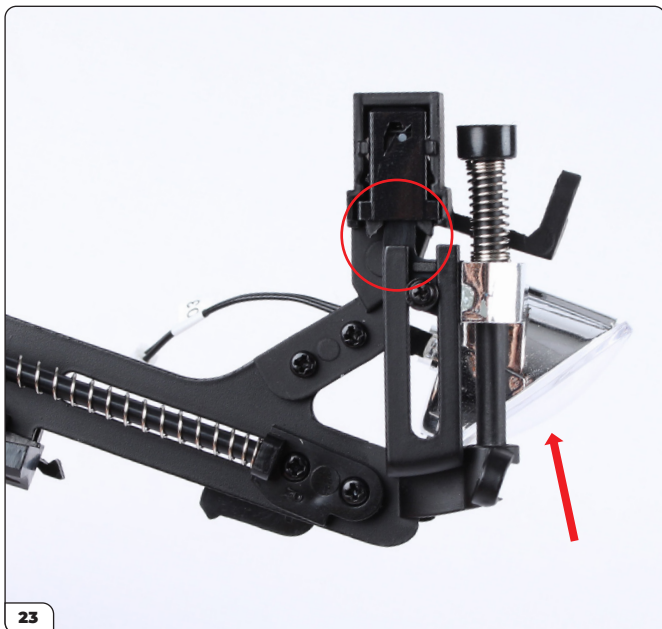

Push the headlight until it clicks into the clamp (circled) and holds in place.



Push the motor (96-L) into the minigun stopper.

Stage 096: Installing the Right Headlight and Minigun Mechanism



Press the motor firmly in place, taking care not to damage the wires.



Push the minigun assembly (stage 095) onto the pin of the motor.



Push the muzzle flash LED (96-M) into the minigun stopper.



Make sure the bulb is pressed firmly in place.

Stage 096: Installing the Right Headlight and Minigun Mechanism



Attaching the Mechanism

Push the mechanism onto the main body.

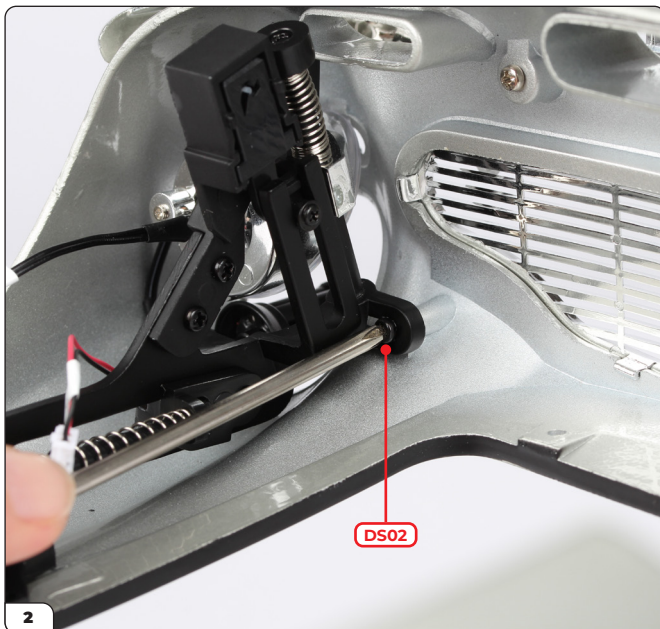

Screw the mechanism to the first screw post with a DS02 screw.



Screw the mechanism to the second screw post with a DS02 screw.

Stage 096: Installing the Right Headlight and Minigun Mechanism

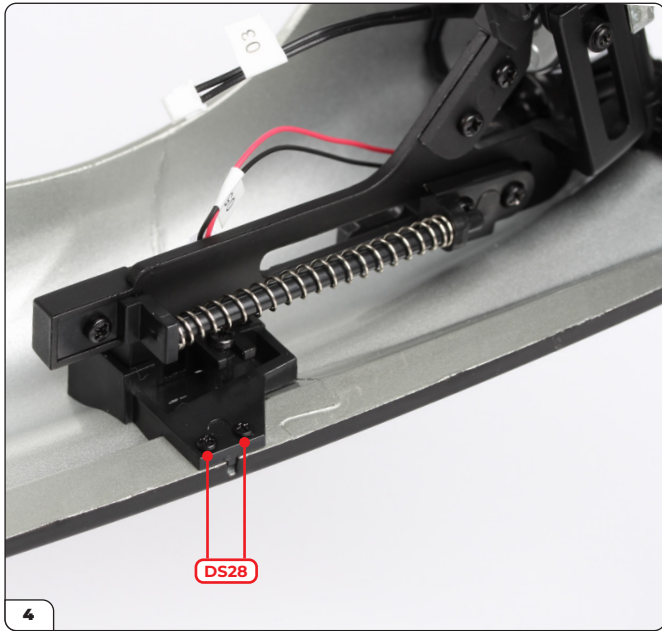

Screw mechanism part 3 (96-C) to the main body with 2x DS28 screws.



To return the headlight, push the minigun back inside until it clicks.



Push down on the headlight to release it from the clamp.



The headlight will pop back up into place. To change back to the minigun, repeat these steps in reverse.

Stage 096: Installing the Right Headlight and Minigun Mechanism

STAGE COMPLETE



Stage 097: Building the Left Headlight and Minigun

In this stage you'll build the left headlight and the M134 minigun



STAGE 097 PARTS LIST

Name	Name
97-A Headlight housing (L)	97-H M134 barrel clamp
97-B Headlight reflector	97-I M134 muzzles
97-C Headlight glass	97-J M134 barrel cluster
97-D Headlight cover	97-K Light rod x6
97-E Headlight bezel	97-L Headlight LED '02'
97-F Foglight lens	PS21 screws x3
97-G Foglight mount	DS41 screws x2



Stage 097: Building the Left Headlight and Minigun

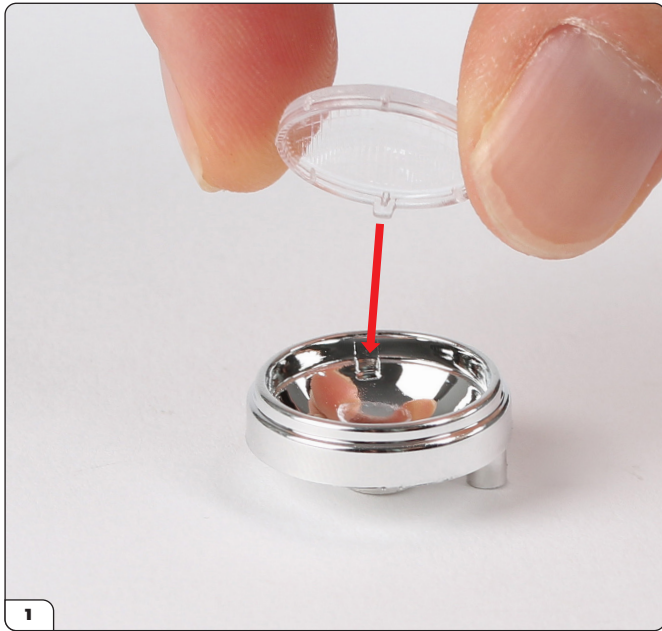

Press the headlight glass (97-C) into the reflector (97-B). There is a small tab which goes into a small recess (arrow).

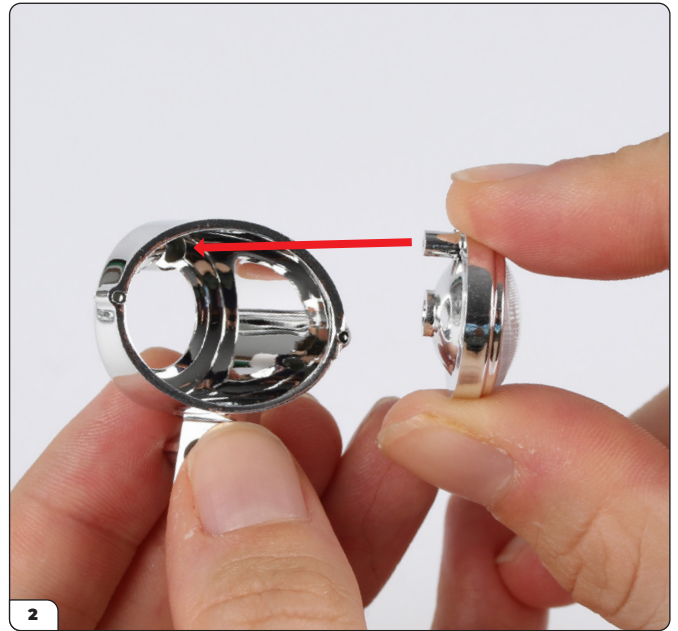

Push the reflector into the left headlight housing (97-A).



Screw the parts together with a PS21 screw.



Press the headlight cover (97-D) into the headlight housing. You may need to remove excess paint from the holes.

Stage 097: Building the Left Headlight and Minigun



Push the headlight LED (97-L) into the headlight housing.

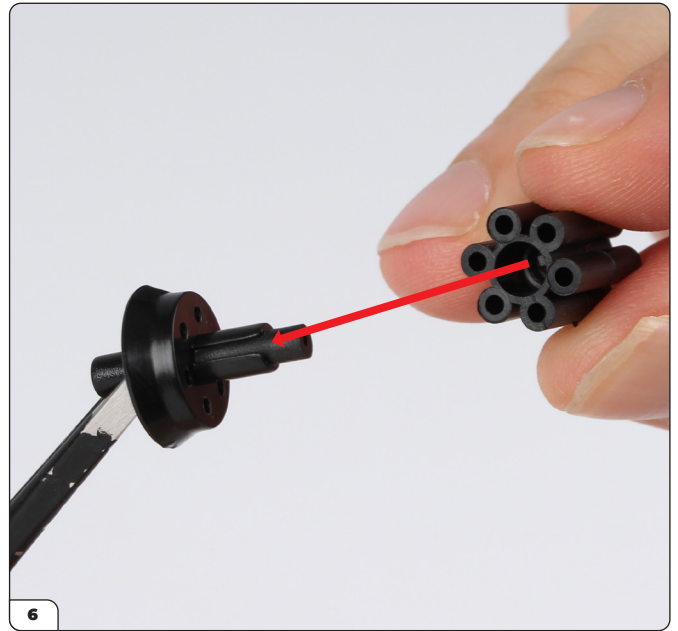

Push the barrel cluster (97-J) onto the barrel clamp (97-H). There is a recess on the barrel clamp so it only fits in one way.

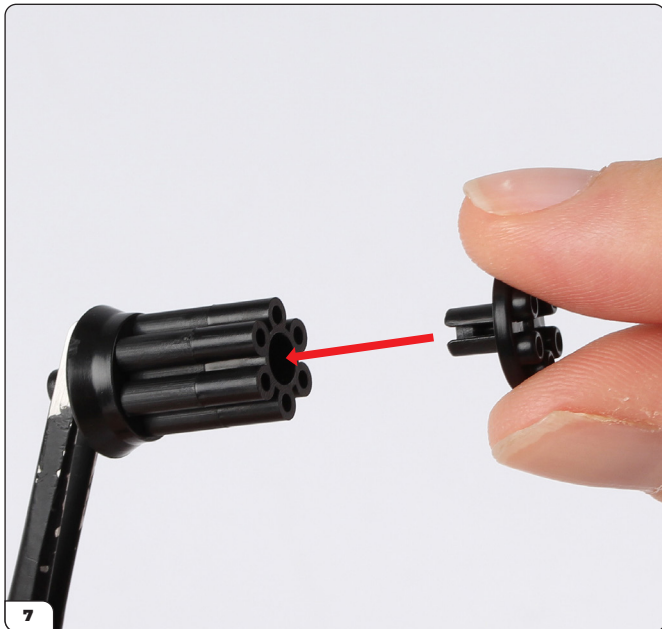

Push the muzzles (97-I) into the barrel cluster. This part also has a recess so can only fit in one way.

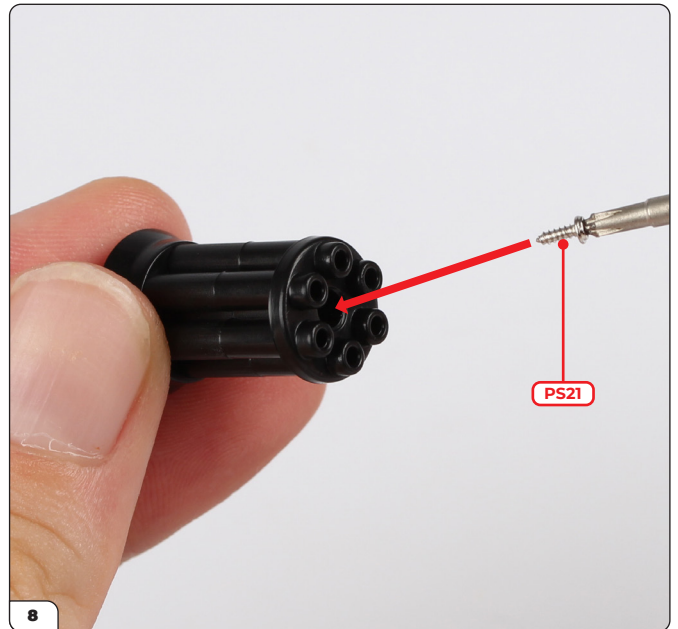

Screw the parts together with a PS21 screw.

Stage 097: Building the Left Headlight and Minigun

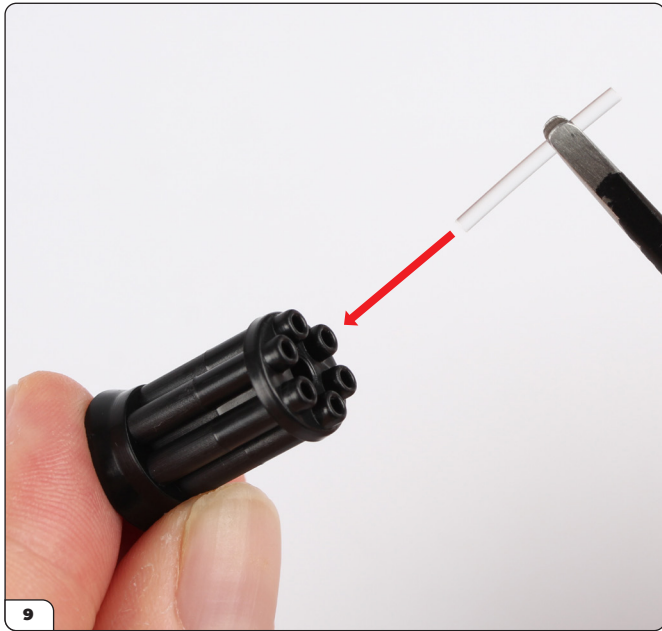

Take one of the light rods (97-K) and push it into a barrel.



Take another light rod and press it into another barrel. You may find it easier to push the light rods in by pressing down on the table as shown.



Continue until all six light rods have been inserted into the barrels.

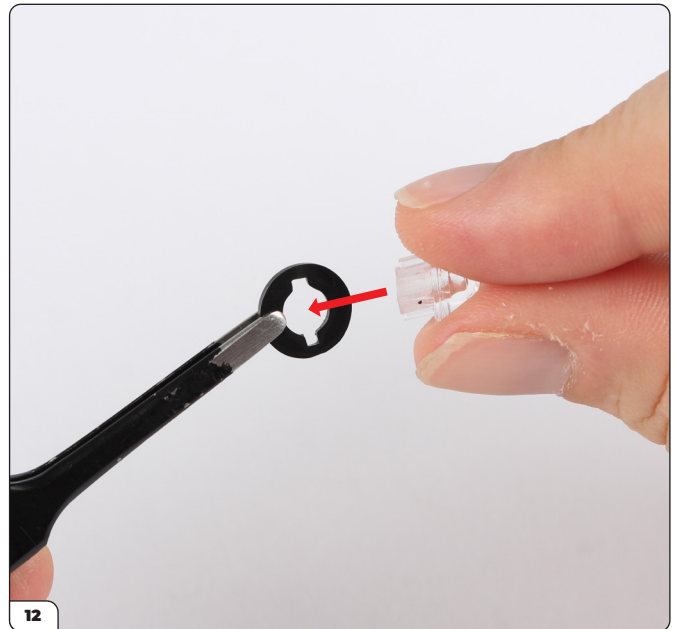

Push the foglight lens (97-F) into the foglight mount (97-G).

Stage 097: Building the Left Headlight and Minigun



Push the foglight into the main body.



Place the headlight bezel onto the main body.



Screw the bezel to the main body with a DS41 screw.

Stage 097: Building the Left Headlight and Minigun

STAGE COMPLETE



Stage 098: Installing the Left Headlight and Minigun Mechanism

In this stage you'll build and install the mechanism that operates the left headlight and minigun.



STAGE 098 PARTS LIST

Name	Name
98-A Mechanism part 1	98-J Short spring
98-B Mechanism part 2	98-K Long spring
98-C Mechanism part 3	98-L Motor with wires '05'
98-D Minigun stopper	98-M Muzzle flash LED '07'
98-E Minigun stopper bracket	DS02 screws x6
98-F Headlight stopper	DS03 screws x2
98-G Cap	PS05 screws x5
98-H Clamp x2	PS17 screws x2
98-I Shaft	DS28 screws x3



Stage 098: Installing the Left Headlight and Minigun Mechanism

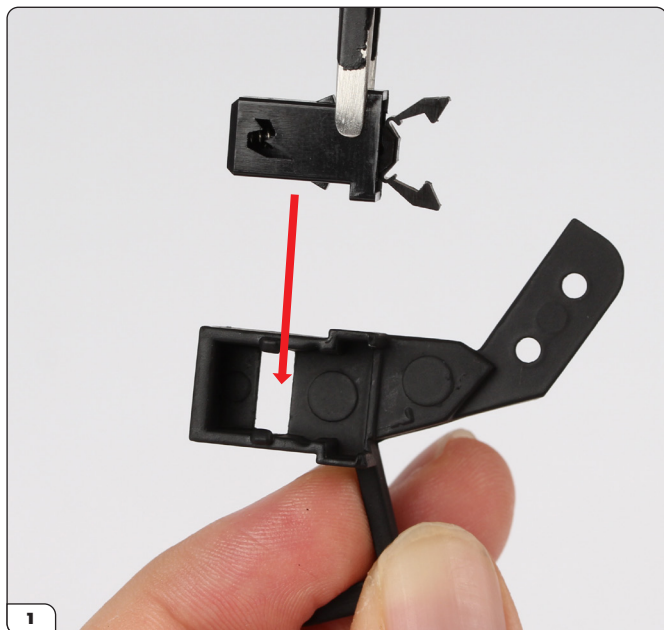

Assembling the Headlight Minigun Mechanism
Press one of the clamps (98-H) into the mechanism part 2 (98-B).



Press the other clamp into the mechanism part 1 (98-A).

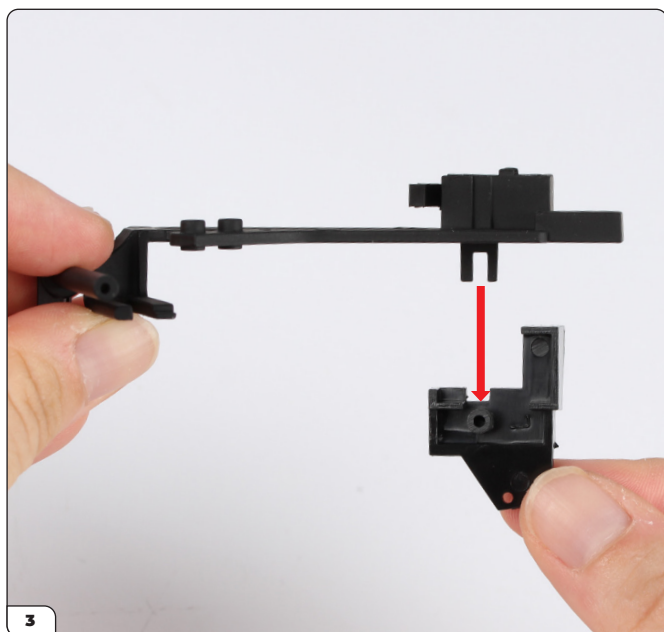

Push mechanism part 1 into mechanism part 3 (98-C) in the orientation shown.

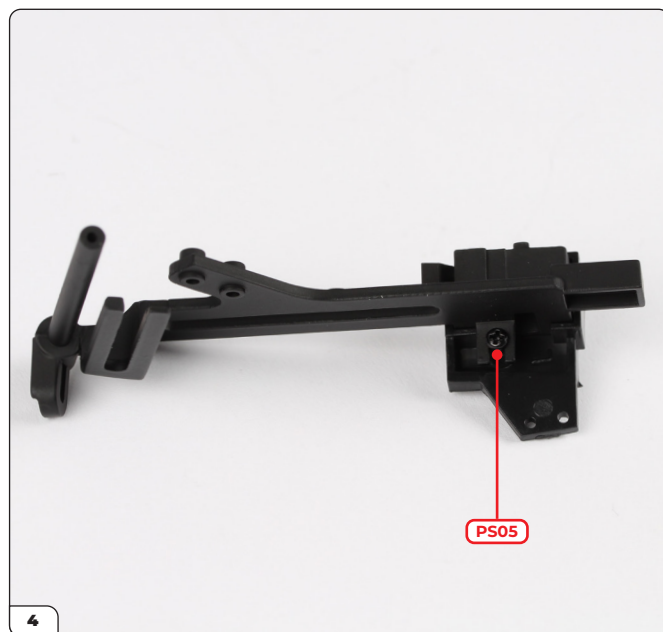

Screw the parts together with a PS05 screw.

Stage 098: Installing the Left Headlight and Minigun Mechanism

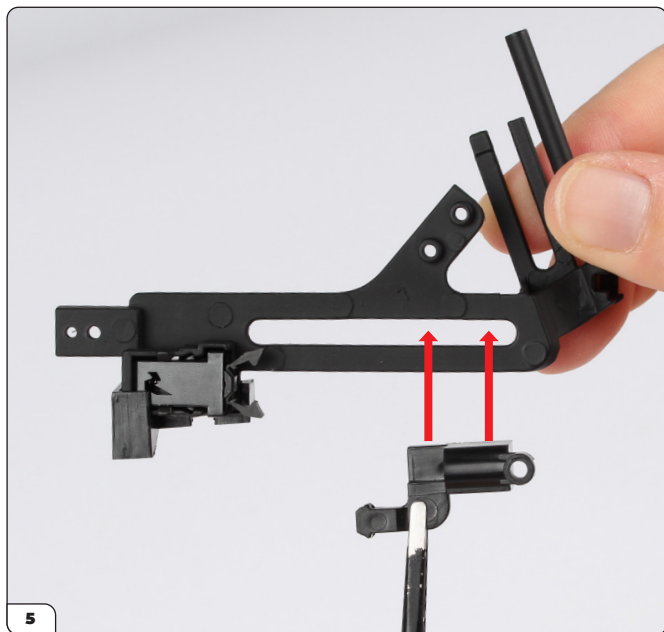

Place the minigun stopper (98-D) into the rail on part 1 in the orientation shown.



The minigun stopper will align with the clamp when in place

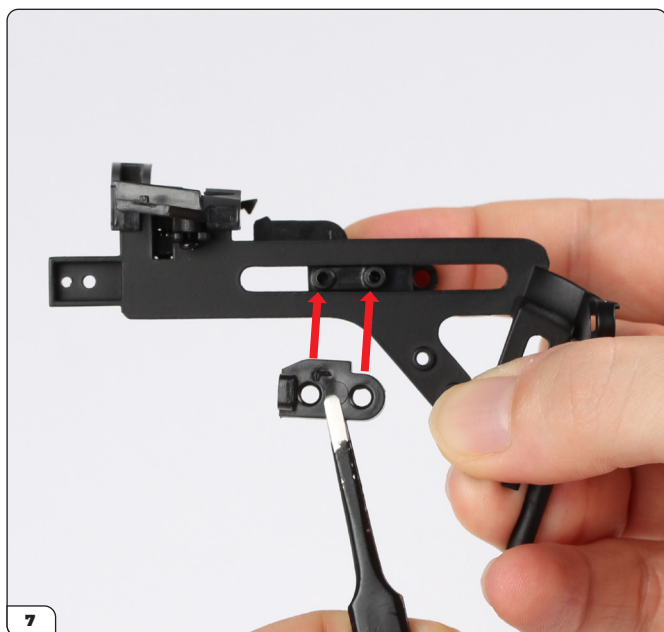

Hold the minigun stopper in place and turn the assembly over. Place the minigun stopper bracket (98-E) over the screw holes in the orientation shown.

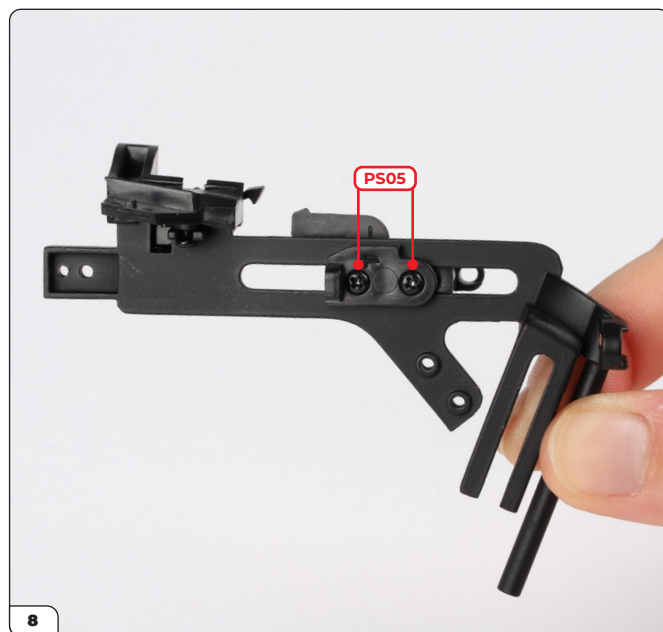

Screw the parts together with 2x PS05 screws.

Stage 098: Installing the Left Headlight and Minigun Mechanism

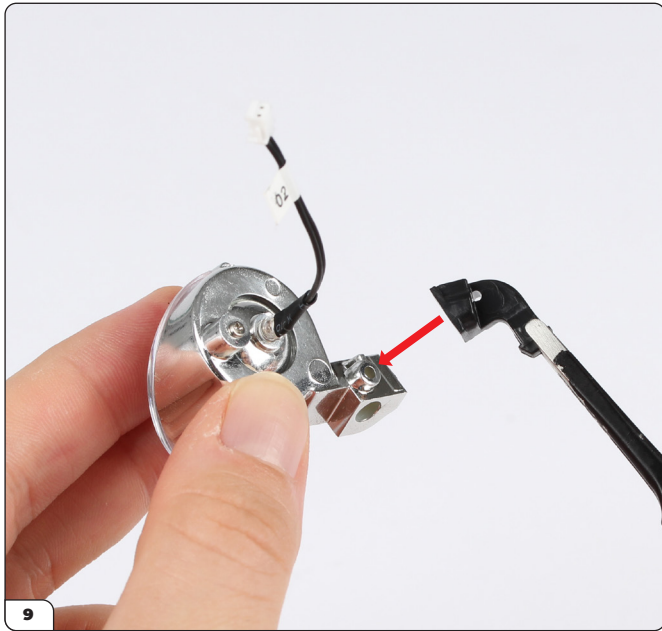

Push the headlight stopper (98-F) onto the left headlight housing (stage 097).

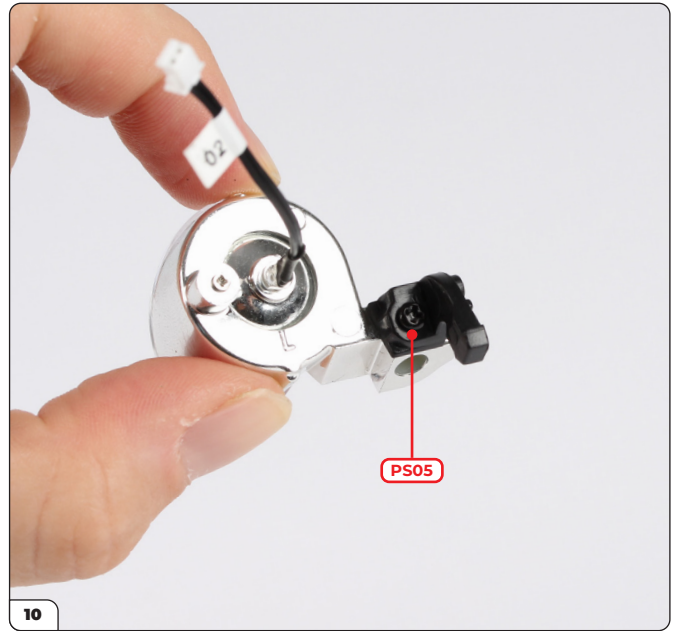

Screw the parts together with a PS05 screw.



Place the long spring (98-K) onto the shaft (98-I).



Push the shaft into the minigun stopper bracket.

Stage 098: Installing the Left Headlight and Minigun Mechanism

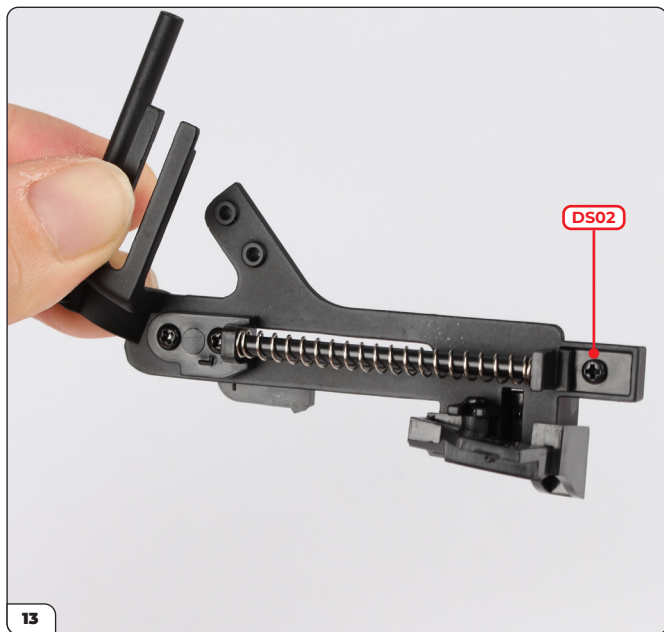

Push the other end of the shaft into the recess and screw it in using a DS02 screw.



Push the left headlight housing onto part 1, fitting the headlight stopper between the rails as shown by the blue arrow.

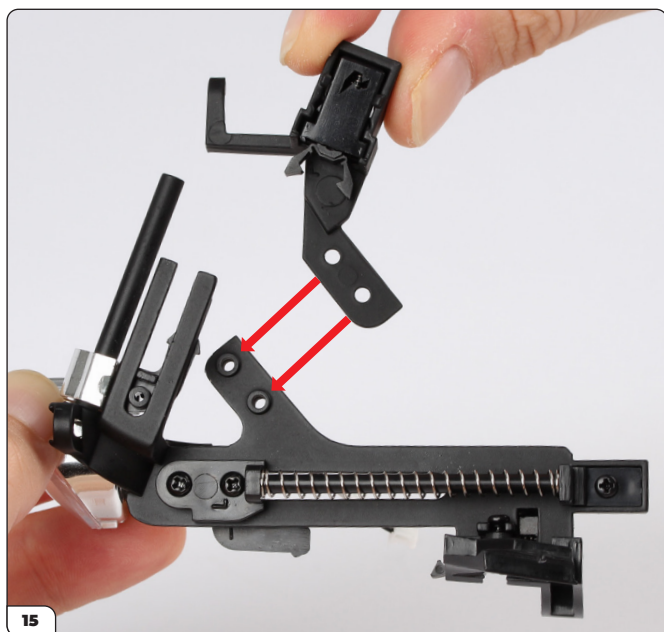

Take mechanism part 2 (from step 1) and place it over the two screw holes.

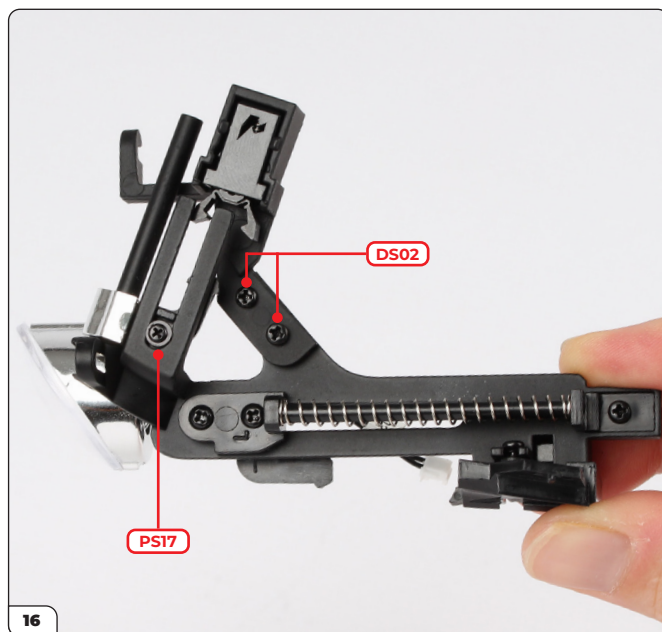

Screw the parts together with 2x DS02 screws. Screw the headlight stopper with a PS17 screw.

Stage 098: Installing the Left Headlight and Minigun Mechanism

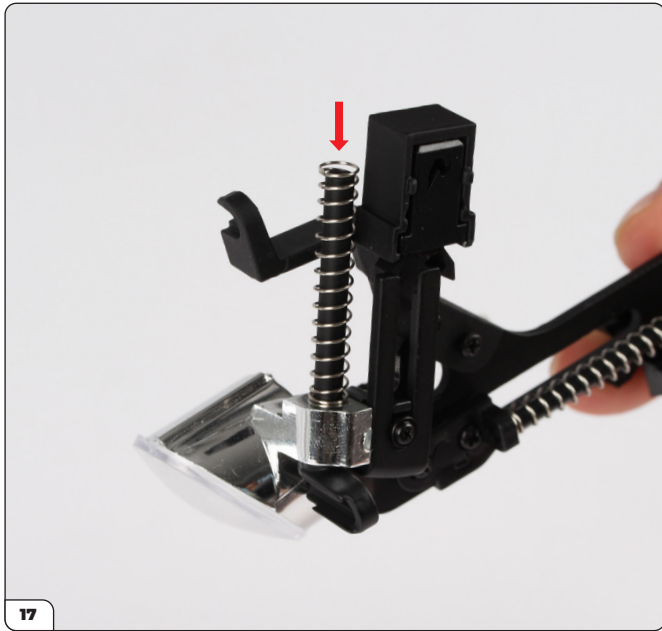

Place the short spring (98-J) onto the headlight shaft.



Push the cap (98-G) over the end of the shaft.



Screw the cap to the shaft with a DS02 screw.

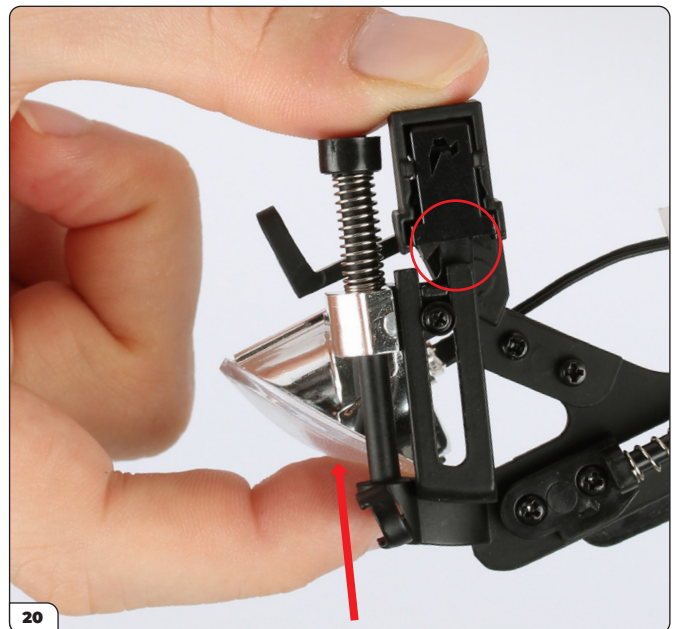

Push the headlight until it clicks into the clamp (circled) and holds in place.

Stage 098: Installing the Left Headlight and Minigun Mechanism

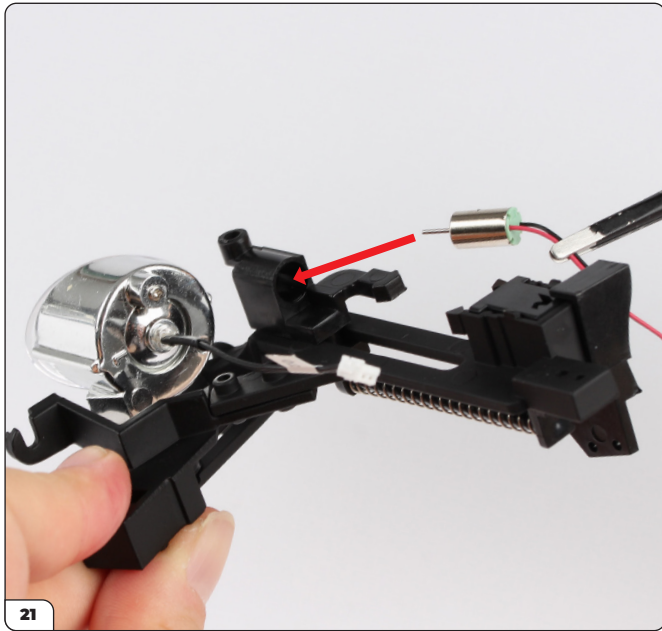

Push the motor (98-L) into the minigun stopper.

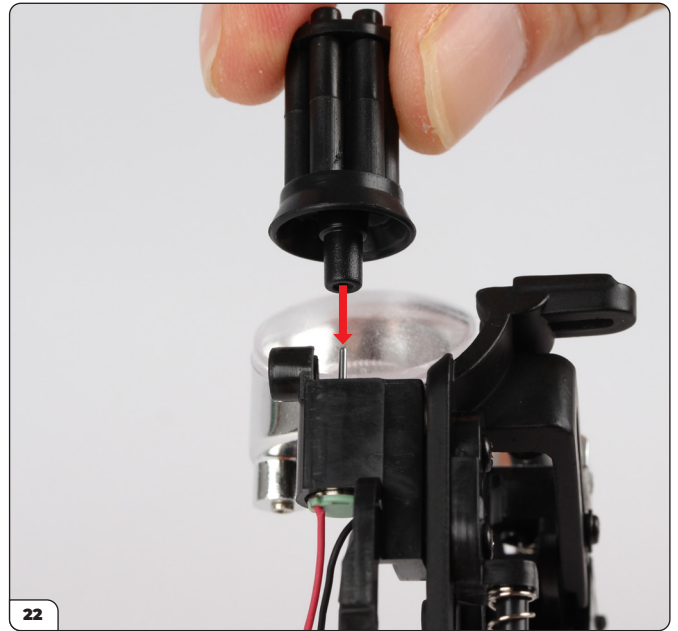

Push the minigun assembly (stage 097) onto the pin of the motor.

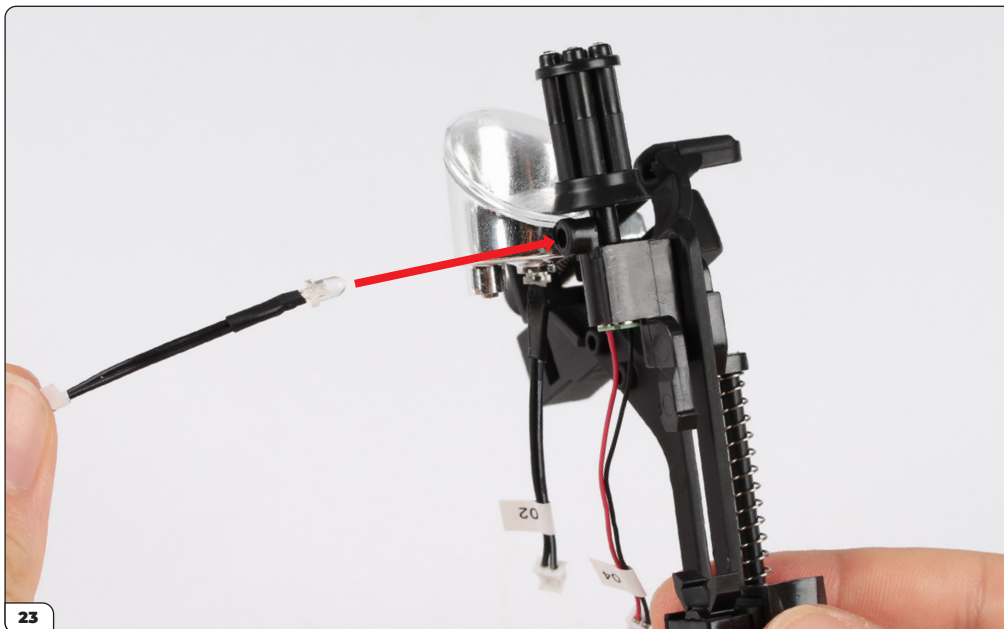

Push the muzzle flash LED (98-M) firmly into the minigun stopper.

Stage 098: Installing the Left Headlight and Minigun Mechanism



Attaching the Mechanism

Push the mechanism onto the main body.

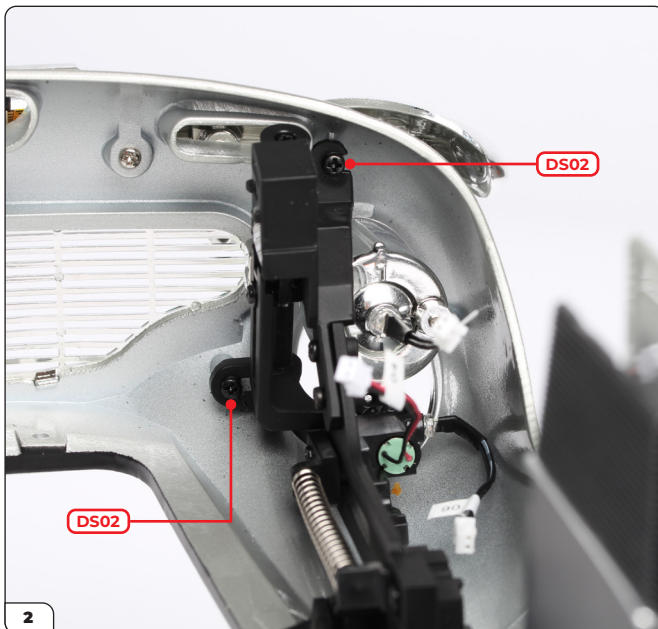

Screw the mechanism to the posts with 2x DS02 screws.

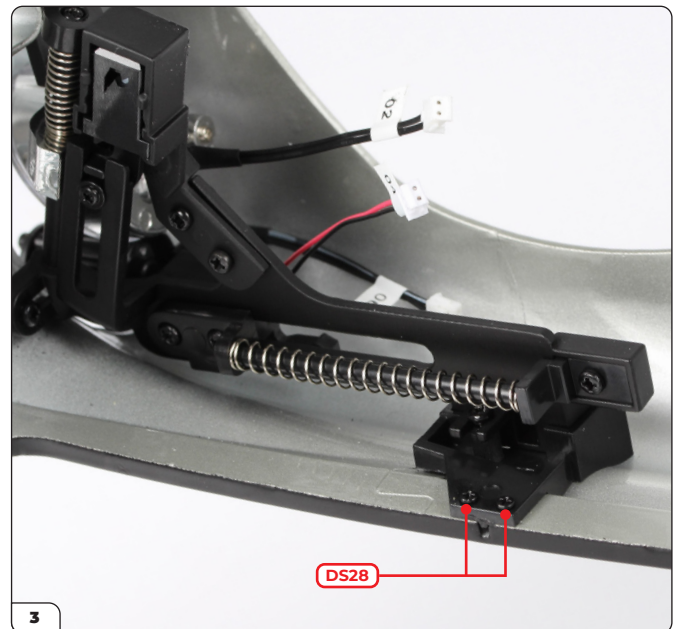

Screw mechanism part 3 (98-C) to the main body with 2x DS28 screws.

Stage 098: Installing the Left Headlight and Minigun Mechanism

STAGE COMPLETE



Stage 099: Building the Remote Control

In this stage you'll build the remote control which operates the electric functions. You'll also attach the bonnet struts to your model.



STAGE 099 PARTS LIST

Name
99-A Bonnet strut x2
99-B Remote control battery cover
99-C Remote control body
99-D Remote control buttons
99-E Remote control front
99-F Remote control circuit board
DS29 screws x3
PS32 screws x8

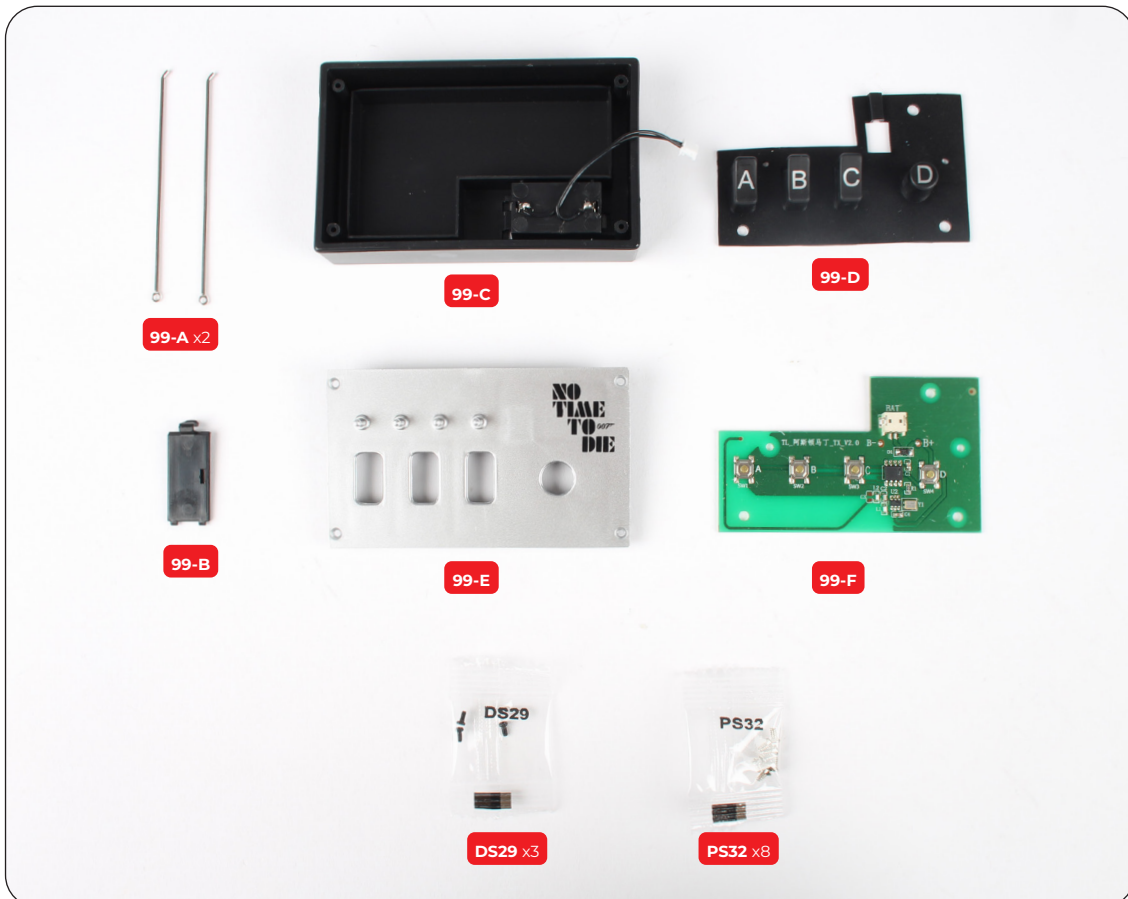

Stage 099: Building the Remote Control

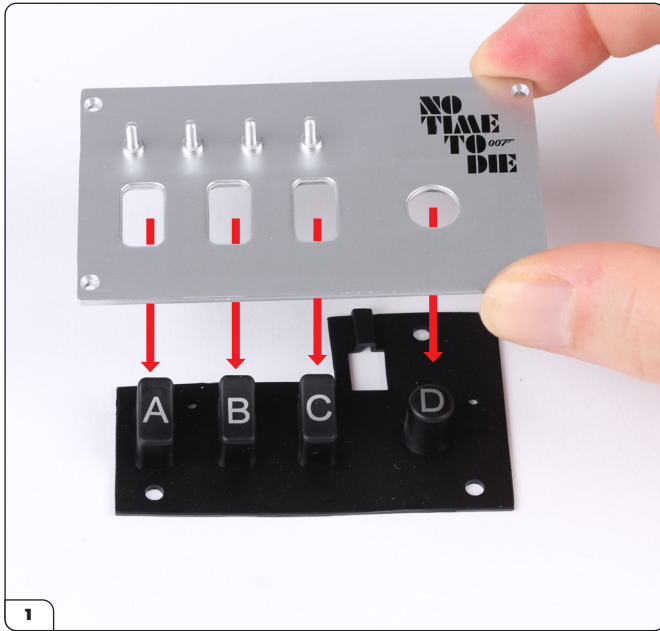

1 Push the remote control front (99-E) onto the buttons (99-D).

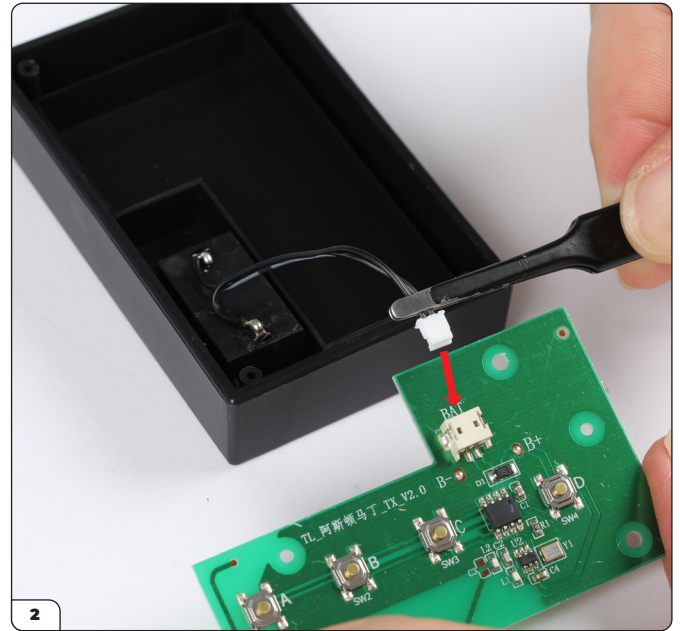

2 Plug the remote control body (99-C) into the circuit board (99-F).

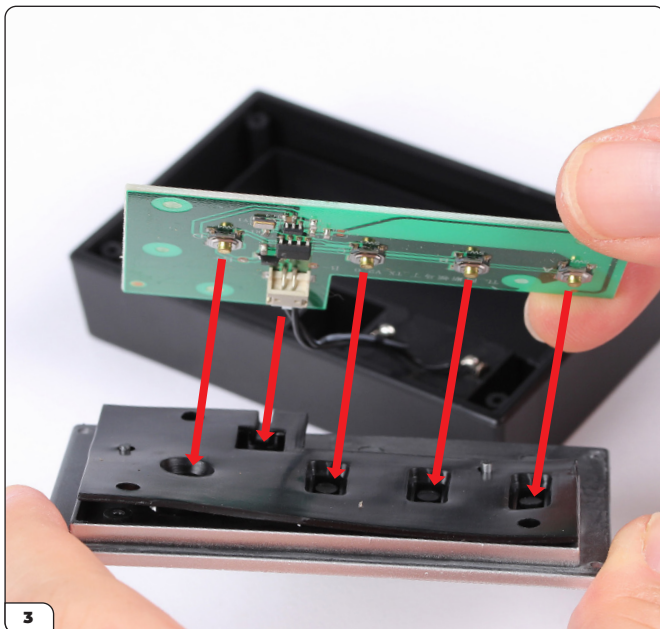

3 Push the circuit board into the buttons.

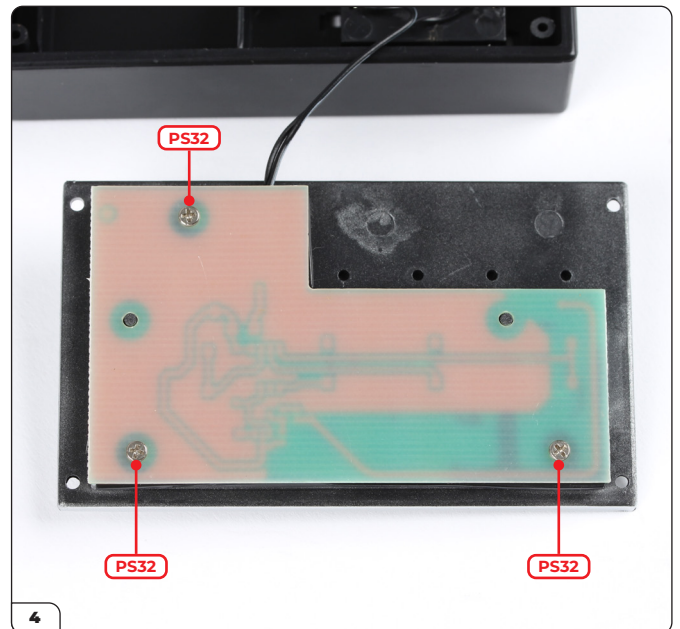

4 Screw the circuit board to the remote control front with 3x PS32 screws.

Stage 099: Building the Remote Control



Place the remote control front onto the body. Make sure the wire does not get trapped (circled).

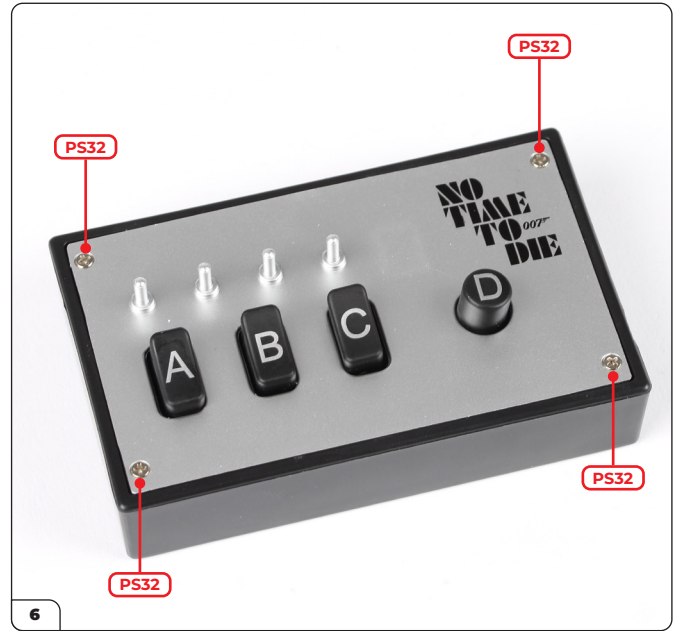

Screw the remote control front to the body with 4x PS32 screws.



Insert 3x LR44 batteries into the remote control then fit the battery cover (99-B).



Align one of the bonnet struts (99-A) with the main body as shown. Make sure the end (circled) is pointing upwards.

Stage 099: Building the Remote Control



Screw the bonnet strut to the main body with a DS29 screw.



Screw the second bonnet strut to the main body with a DS29 screw in the same way.



Stage 100: Attaching the Chassis and Body

In the final stage you'll attach the chassis to the body and finish adding the last details to your model. You'll also have options to install slim-line tyre slashers and apply scratched paintwork to your model.



STAGE 100 PARTS LIST

Name
100-A Roof panel
100-B Slim-line rear hub cap x2
100-C Mine scoop
100-D Minimine x8
Scratched paintwork decal sheets
DS02 screws x7
PS05 screws x8
DS12 screws x3

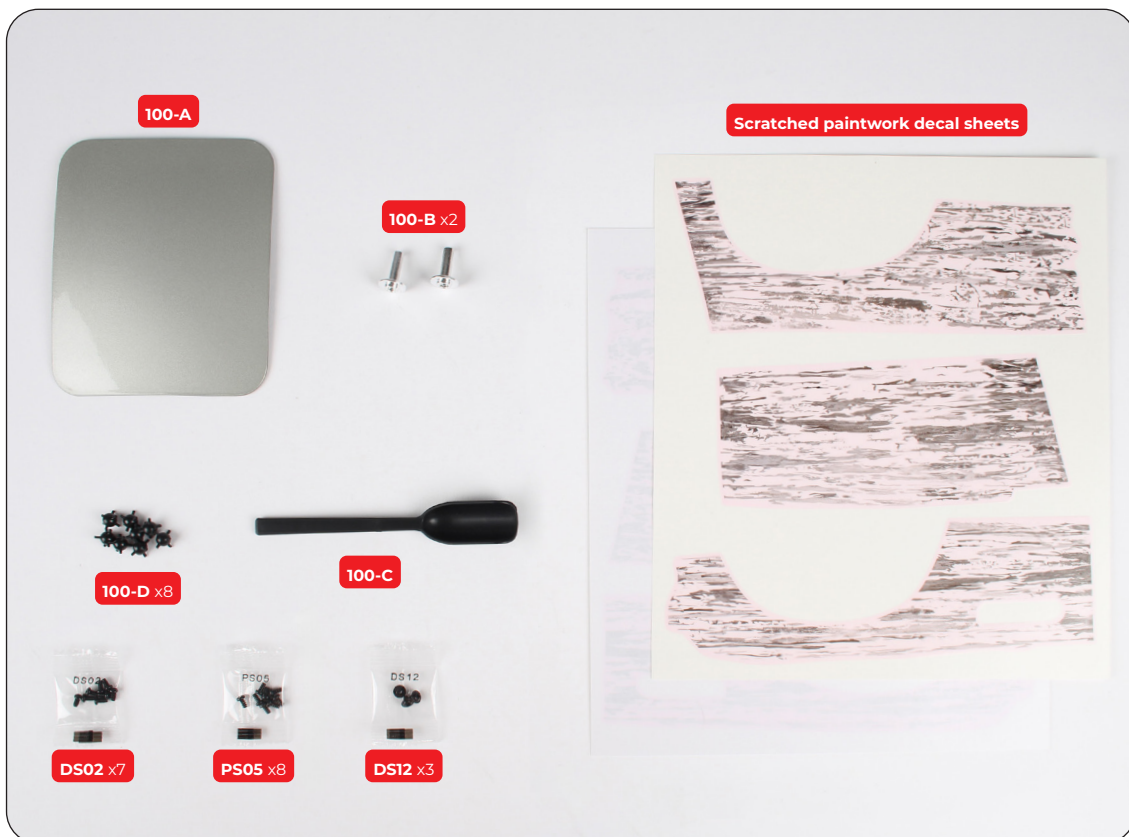

Stage 100: Attaching the Chassis and Body

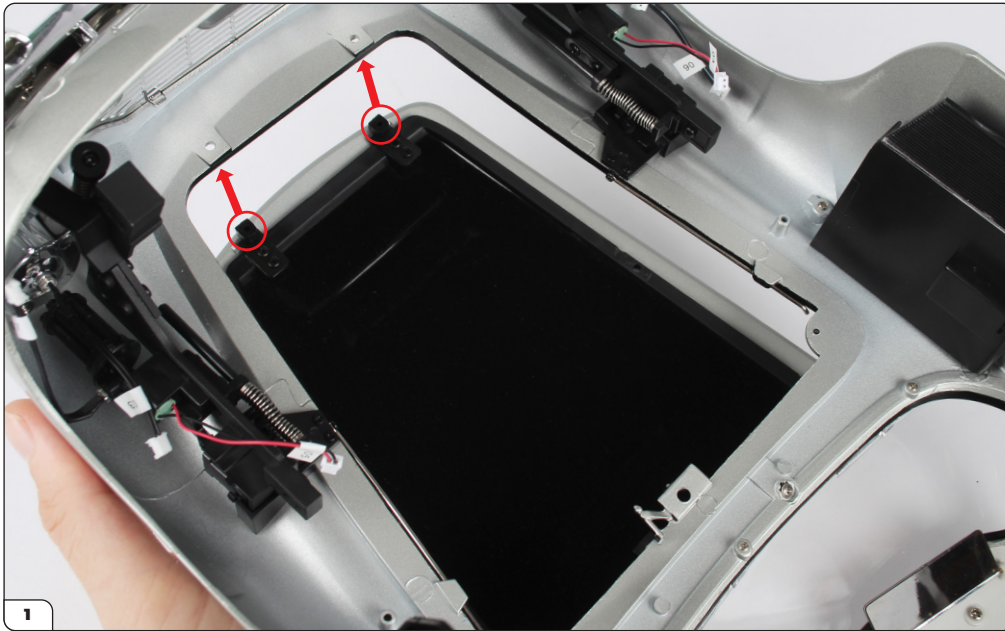

Place the main body (stage 099) upside down on your work surface. Align the bonnet (stage 001) with the main body. Check that the hinge joints (circled) are pointing upwards, then push them into place.

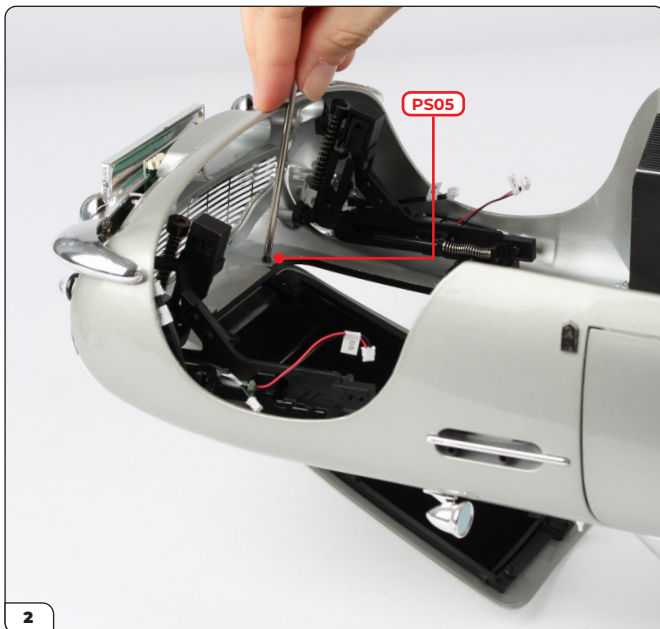

To secure the bonnet, start by screwing a PS05 screw halfway into one of the hinges. This may be easier with the bonnet open as shown.



Close the bonnet, making sure the bonnet lock goes into the hole (circled). Screw a PS05 screw halfway into the other hinge. Tighten both screws firmly once you are happy with the placement of the bonnet.

Stage 100: Attaching the Chassis and Body



Bend the wires at the front over the wheel arches.

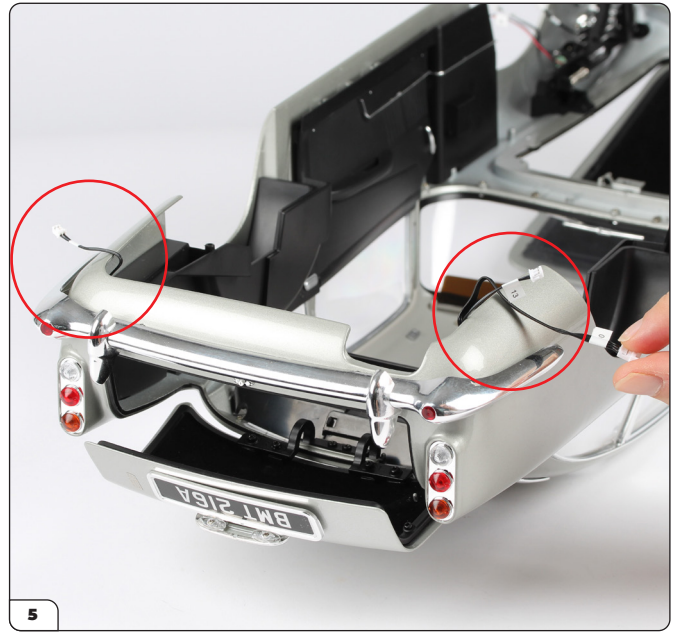

Bend the wires at the rear over the body.

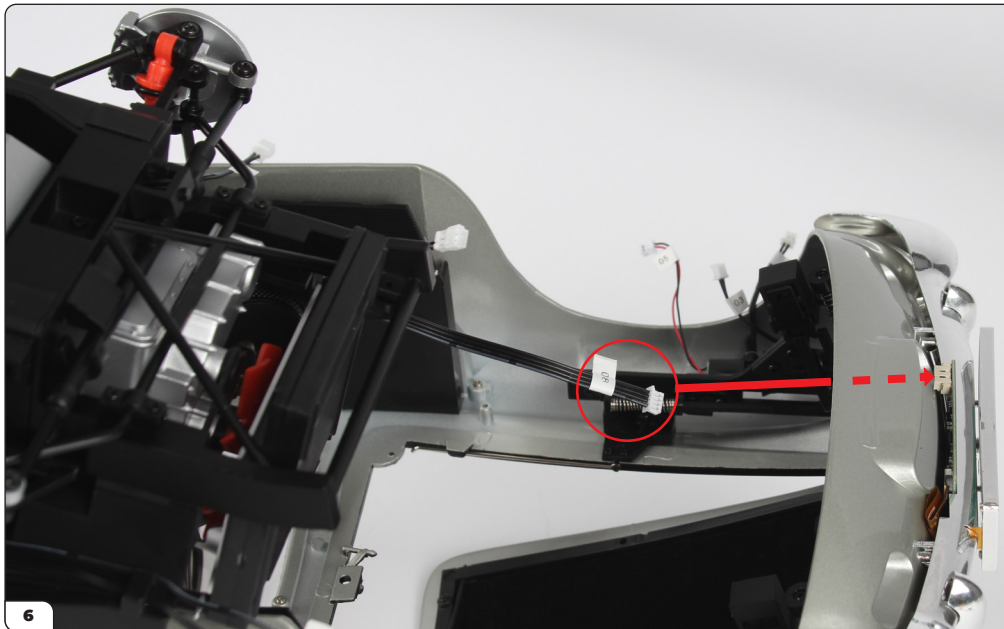

Take the chassis assembly (stage 068). Align it with the main body and push the cable No. 08 (circled) through the opening. Plug the cable into the front number plate circuit board (6b).

If you are using the non-LED number plates, tuck the cable out of the way as you fit the chassis.

Stage 100: Attaching the Chassis and Body



Carefully lower the front of the chassis into the main body.

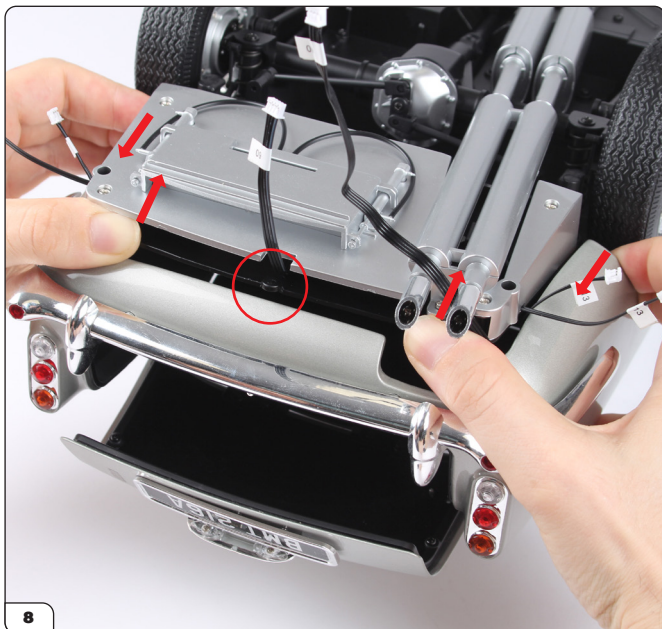

Note the screw hole (circled) at the rear of the chassis. Push the end of the chassis with your thumbs while pulling the rear wheel arches in the opposite direction (arrows).



While applying pressure, lower the rear end of the chassis into the body. Make sure the screw hole highlighted in the previous step doesn't damage the body.

Stage 100: Attaching the Chassis and Body



Number	Location	Function
02	Front Left	Headlight
03	Front Right	Headlight
04	Front Left	Minigun motor
05	Front Right	Minigun motor
06	Front Left	Minigun light
07	Front Right	Minigun light
08	Front Right	LED front plate
09	Rear Left	LED rear plate
13	Rear Left	Brake light
14	Rear Right	Brake light

Testing the Electrics

Connect all the cables together at the front and back using the numbered labels.

Check the table above to make sure you have plugged all the cables together. The cables highlighted in grey are only used for the LED number plates.

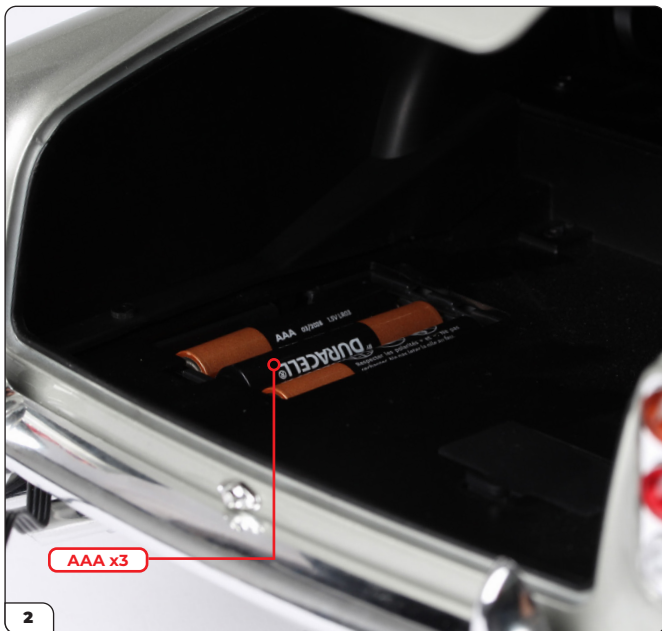

Carefully place the model upright on your work surface. Open the boot and insert 3x AAA batteries into the compartment.



Open the passenger door and switch the power on.

Stage 100: Attaching the Chassis and Body



Press the “B” button on the remote control (stage 099). The rear brake lights will light up. Press the button again to turn them off.



Press the “A” button. The headlights and dashboard lights will turn on. Press the button again to turn them off.



Press the “C” button to cycle through the LED number plates on the front and back.



Press the headlights in and the miniguns out. Press the “D” button to start the minigun motor. The barrels will also illuminate from the LED. Press the button again to turn them off.

Stage 100: Attaching the Chassis and Body



After you have tested the electrics, switch the power off.



Tuck the cables at the rear of the model into the gaps between the body and the chassis.



Tuck the cables at the front of the model into the wheel arches.

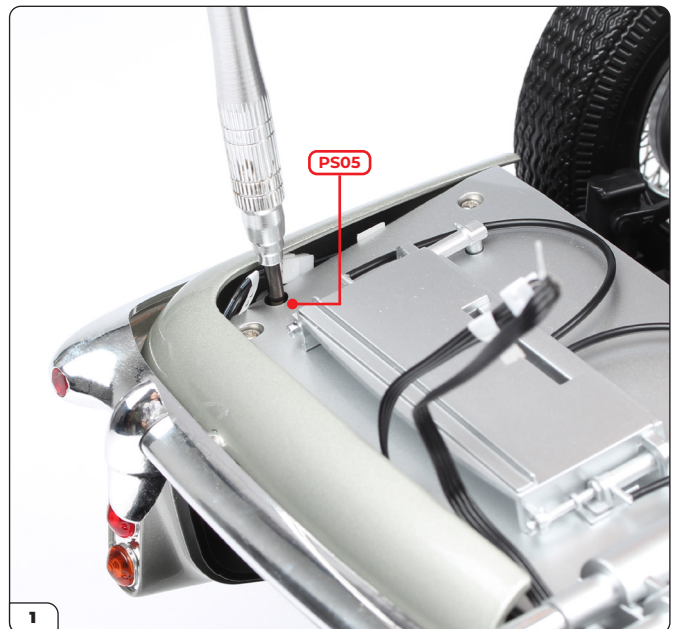

Screwing the Chassis to the Body

Place the model upside down on your work surface. Start to secure the chassis by screwing a PS05 screw into the rear right corner. Tuck the ribbon cable behind the number plate if you haven't done so already.

Stage 100: Attaching the Chassis and Body



Screw a PS05 screw into the rear left corner.

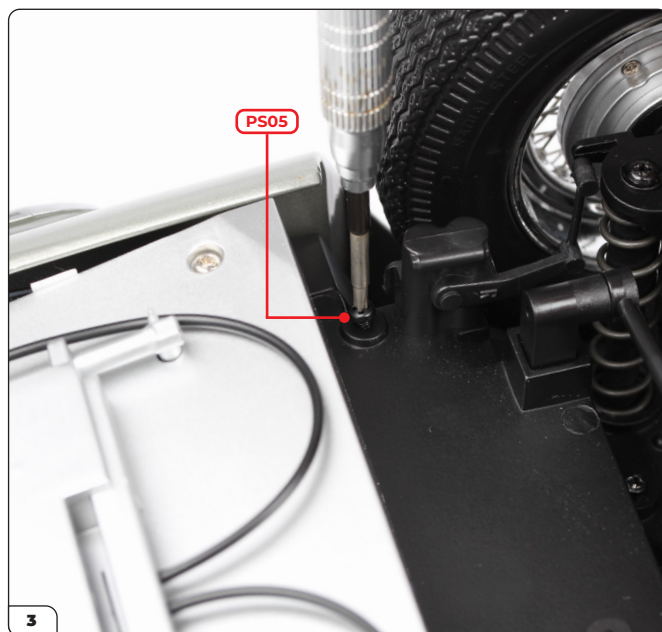

Screw a PS05 screw into the hole behind the rear right wheel.

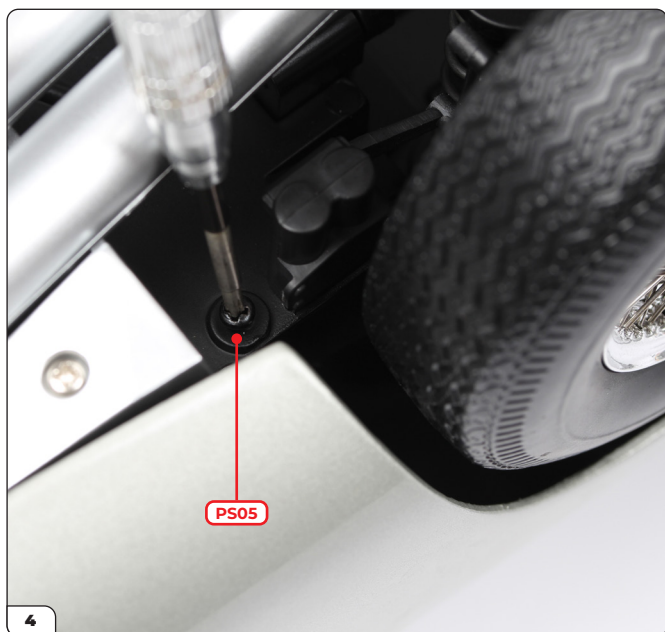

Screw a PS05 screw into the hole behind the rear left wheel.



Screw a PS05 screw into the back of the chassis.

Stage 100: Attaching the Chassis and Body

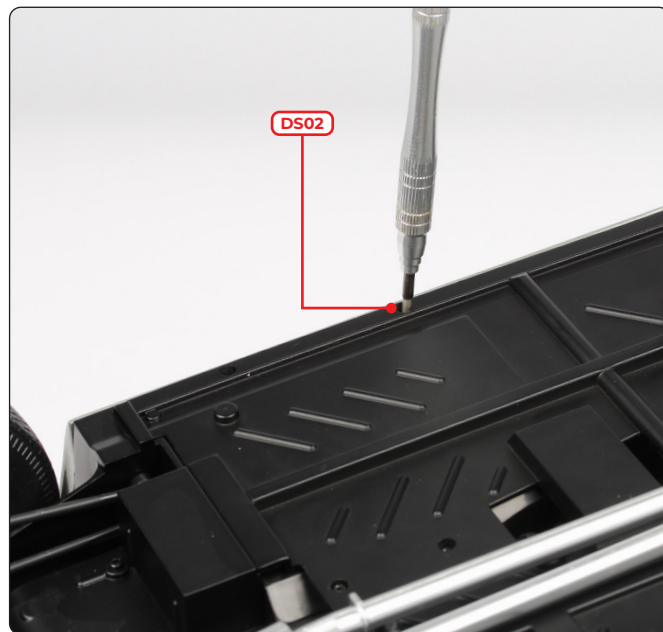
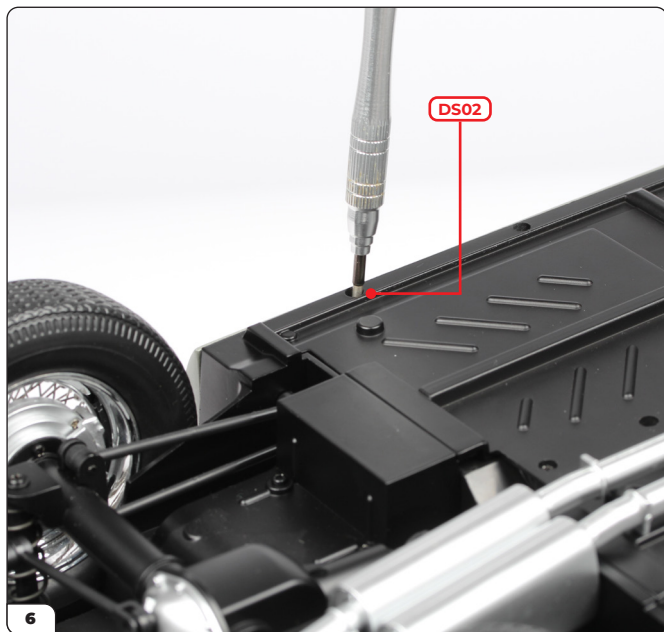

Screw 2x DS02 screws into the two holes on the right side of the chassis.

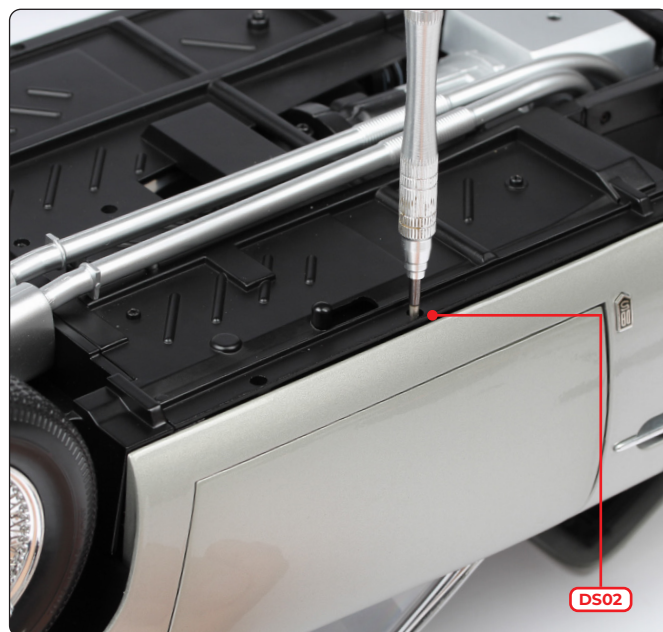
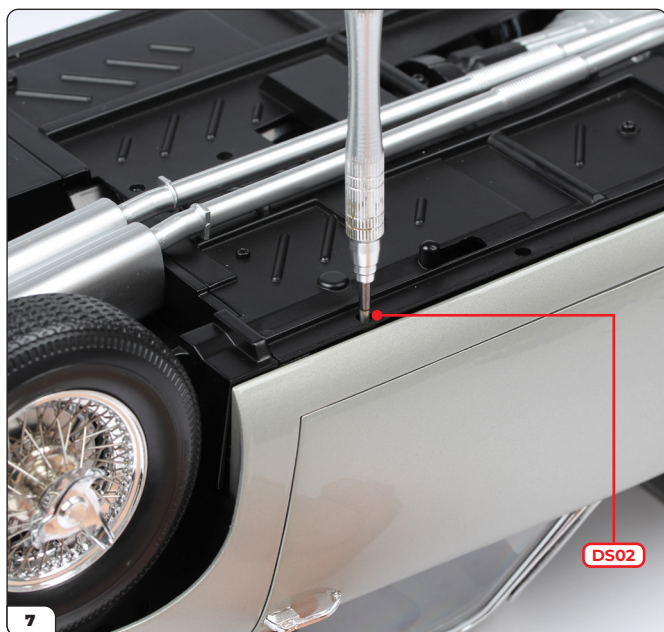

Screw 2x DS02 screws into the two holes on the left side of the chassis.

Stage 100: Attaching the Chassis and Body

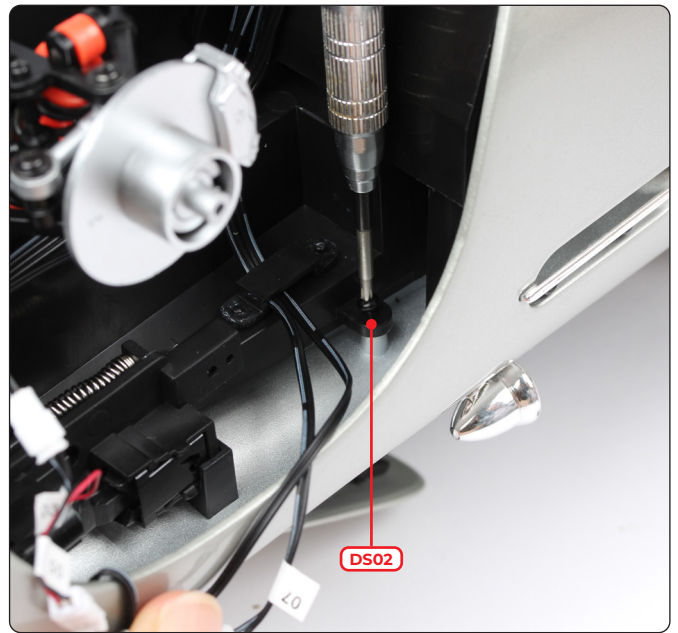
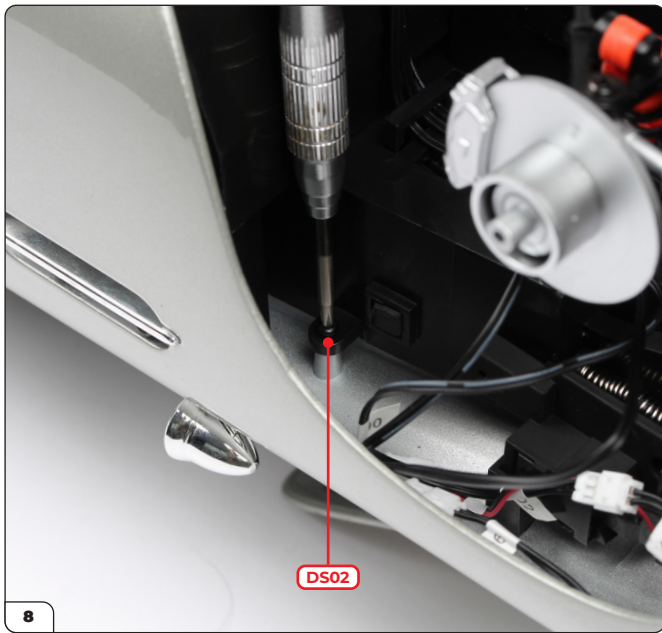

Screw 2x DS02 screws into the two holes in the front wheel arches.

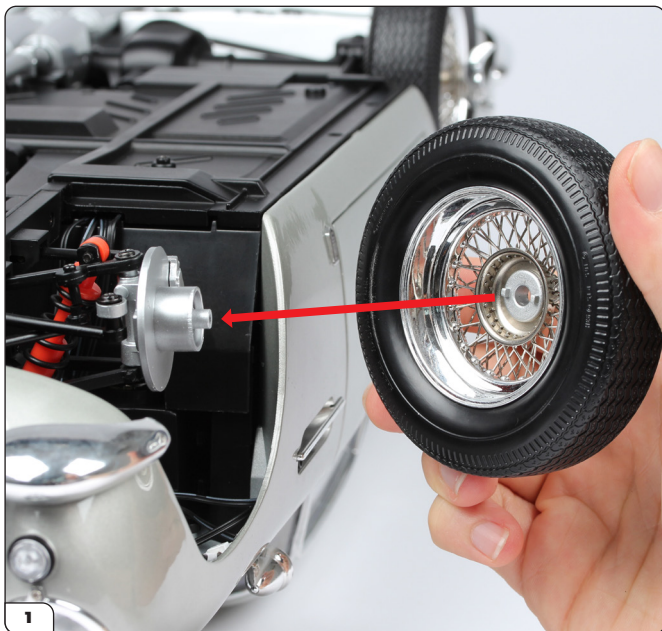

Finishing the Model

Push the wheel (stage 004) onto the front right hub.

Screw a DS12 screw into the hub.

Stage 100: Attaching the Chassis and Body



Place the hub cap (stage 004) onto the wheel. The magnet will hold it in place.



Push the other wheel (stage 029) onto the front left hub and screw in a DS12 screw.



Place the hub cap (stage 029) onto the wheel.



Turn the model upright. Place the roof panel (100-A) onto the opening.

Stage 100: Attaching the Chassis and Body



You will need to remove the roof panel before using the ejector seat!

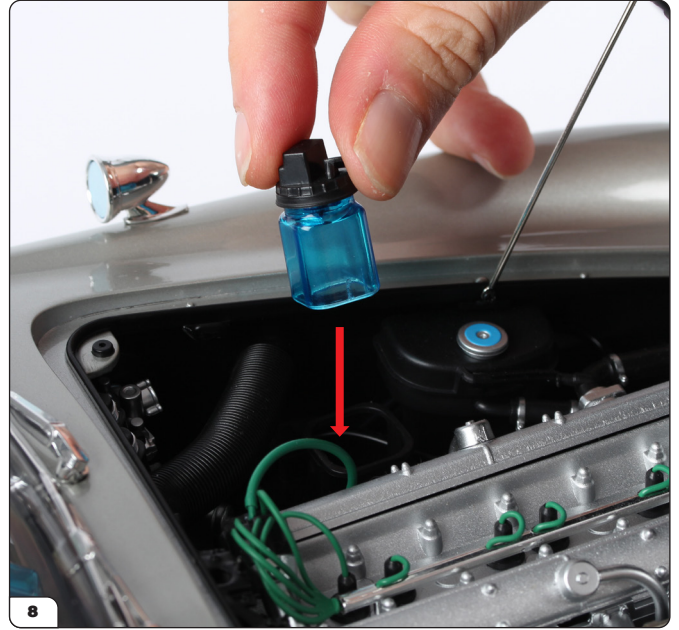

If you placed the washer bottle in a safe place in stage 062, insert it back into the holder.



Open the boot and remove the mine compartment cover. You can use the mine scoop (100-C) to add the minimines (100-D) into the compartment.



To release the minimines, pull open the mine dispenser from underneath.

Stage 100: Attaching the Chassis and Body

Optional Steps

Your *No Time To Die* Aston Martin DB5 is complete, but there are some optional changes you can make in the steps on the following pages.

To change the rear tyre slashers to the slim-line version follow the steps on page 71.

To apply the scratched paintwork decals follow the steps on page 73.



Stage 100: Attaching the Chassis and Body



Installing the Slim-line Tyre Slashers

Pull the tyre slasher and hub cap out from the rear wheel.



Keep the tyre slasher (circled).



Push one of the slim-line rear hub caps (100-B) over the pin in the centre of the wheel.



Push the tyre slasher (from step 2) onto the pin.

Stage 100: Attaching the Chassis and Body



The slim-line tyre slasher has been installed. Repeat steps 1–4 to install the tyre slasher on the other rear wheel.



Stage 100: Attaching the Chassis and Body



Applying the Scratched Paintwork Decals

Take one of the scratched paintwork decal sheets and carefully cut it into three sections.

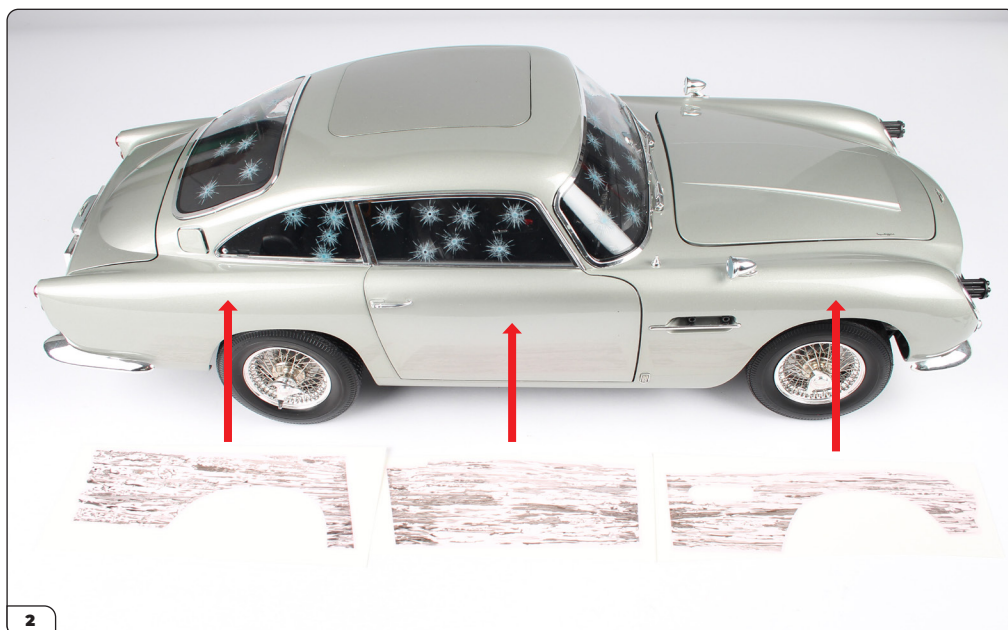

Align the sections with the corresponding panels on the car.

Stage 100: Attaching the Chassis and Body



Place the rear decal into water for 30 seconds. Hold it flat to stop it from curling up.



Use a brush to wet the area on the rear panel.



Slide the decal off the paper and onto the rear panel.



Adjust the decal around the rear wheel arch.

Stage 100: Attaching the Chassis and Body



Apply the middle decal in the same way, making sure to line up the scratches as shown by the arrows.

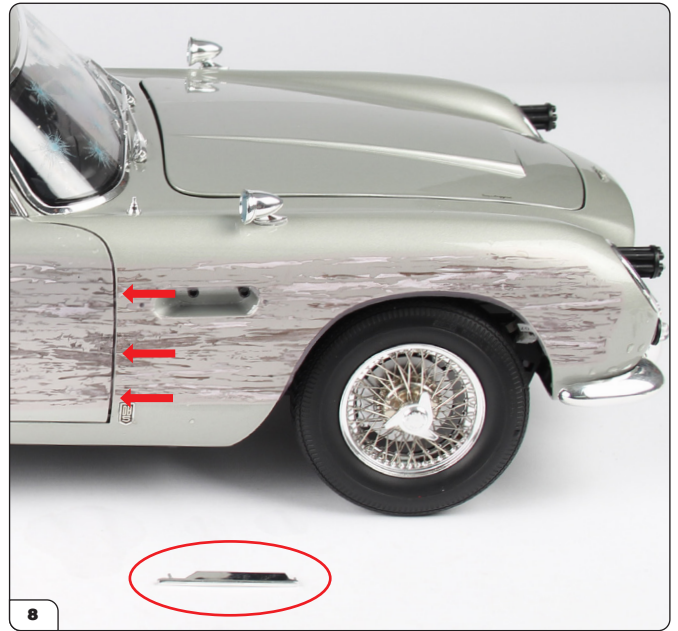

Apply the front decal in the same way, making sure to line up the scratches as shown by the arrows. You may find it easier to remove the side strake first (circled).



Repeat these steps for the decals on the opposite side. Once they have all been applied, wait for 12 hours for the decals to dry.

Stage 100: Attaching the Chassis and Body



After 12 hours, peel away the pink protective film.



Use a wet brush to smooth down any overlapping edges.

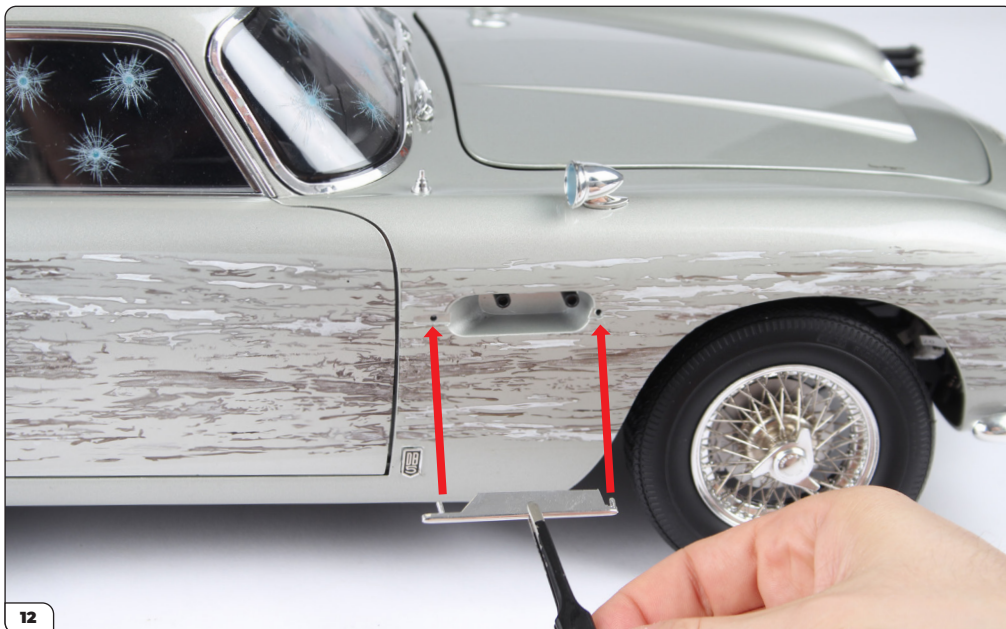

Insert the side strakes back into place.

Stage 100: Attaching the Chassis and Body

STAGE COMPLETE



Your model is now complete!

Don't forget, as an Agora Advantage Club member you will have Reward points to redeem. You may now have enough points to enjoy a free pack 1 for your next model.

[Check your points score in your account.](#)