

Ferrari

250 GTO



Pack 07

BUILD INSTRUCTIONS

STAGE 49: SIDELIGHTS AND INDICATORS

STAGE 50: FOG LIGHTS AND FRONT GRILLE

**STAGE 51: AIR INTAKE COVERS
AND FERRARI BADGE**

STAGE 52: HOT AIR DUCTS

**STAGE 53: THE BONNET LOCKING SYSTEM
(PART 1)**

**STAGE 54: THE BONNET LOCKING SYSTEM
(PART 2)**

**STAGE 55: THE FRONT LEFT SUSPENSION
(PART 1)**

**STAGE 56: THE FRONT LEFT SUSPENSION
(PART 2)**

Advice from the experts

To help you get the best out of building the Ferrari 250 GTO, we've prepared a modellers checklist with hints, tips and advice from our experts. The information below is aimed at making your build as enjoyable and professional as possible right from the start.

Have a soft cloth ready to place on your work surface to prevent scratching the paintwork.

Spare screws are included with each part. Occasionally, you may be instructed to keep spare or unused screws for a later stage. Keep these spares in a safe place and label them correctly.

Please make sure you don't mix up the screws. They look quite similar, but the threads do vary slightly. Using the wrong screws may damage the parts.

When securing parts together using multiple screws, fit each screw loosely to ensure all the parts are correctly aligned before gently tightening them firmly, but not overtight, in the order in which you placed them.

The screwdriver can be magnetized by stroking it with a magnet (fridge magnet, etc.) enabling it to hold the screws and make assembly easier.

If a screw is tight going into a metal part, do not force it as you may shear the head off. Remove it and put a tiny smear of Vaseline, soap or light oil on the thread. That will lubricate it and make it easier to drive home.

Only use the correct size screwdriver that fits the screw head firmly.

Use a magnet to help find screws that have fallen on the floor.

Use masking tape to hold parts temporarily in place.

Cut parts from a sprue (framework) with side cutters or a craft knife. Side cutters tend to be easiest.

During the course of this build, you will receive many pieces that you will assemble immediately – following the instructions in the corresponding stage – and other pieces that you should store safely to one side, for use in future assembly stages.

Left and Right! When building your *Ferrari 250 GTO*, the left- or right-hand side refers to that side as if you are sitting in the car.



WARNING: Some parts are assembled using magnets. These magnets can cause serious injury if they are swallowed. Keep away from children. If you suspect a magnet has been swallowed, seek medical help straight away.

All parts belong to a kit. Collectors item for adults.

Not suitable for children under 14.

Produced under license of Ferrari S.p.A. The name FERRARI, the PRANCING HORSE device, all associated logos and distinctive designs are property of FERRARI S.p.A. The body designs of the Ferrari cars are protected as Ferrari S.p.A. property under design, trademark and trade dress regulations.

Stage 49: Sidelights and Indicators

In this stage you'll fit the sidelights and indicators to the front of the body.



STAGE 49 PARTS LIST

Name	Name
1 Sidelights	6 Left indicator wiring
2 Left indicator lens	7 Right indicator wiring
3 Right indicator lens	
4 Left indicator housing	
5 Right indicator housing	

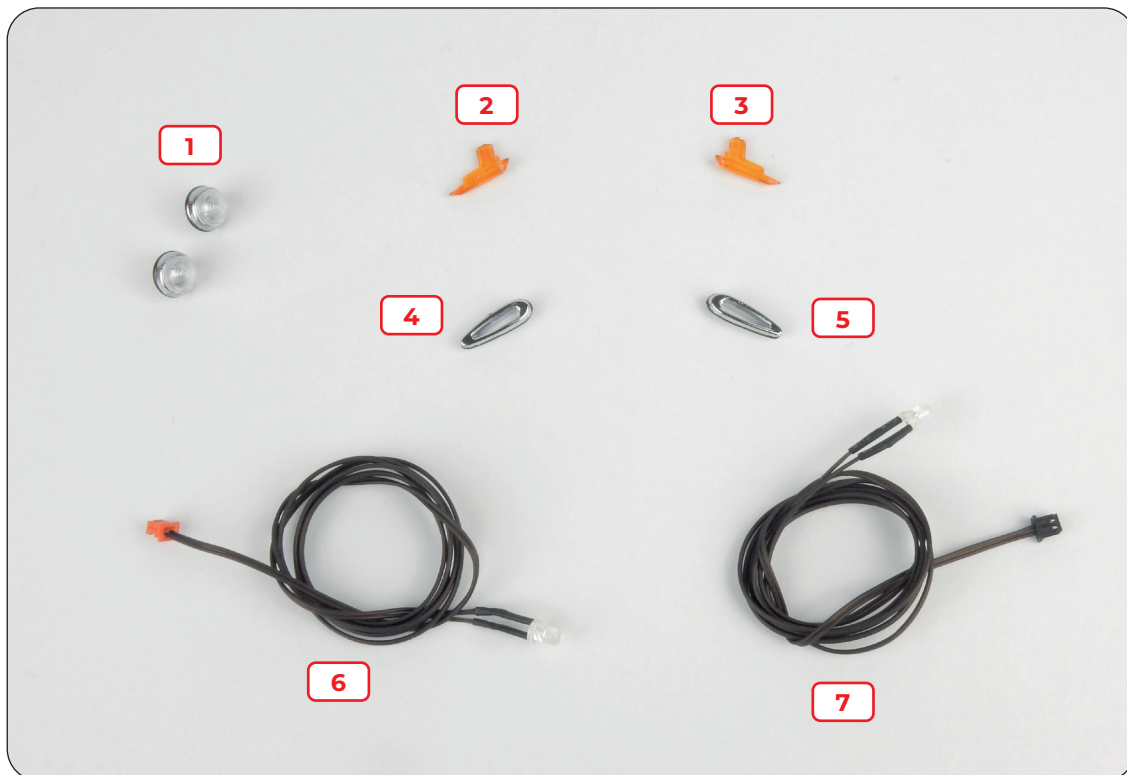

Stage 49: Sidelights and Indicators



49/01 Place the front section of the body, one of the sidelights, the left indicator housing and the left indicator lens on your work surface. The housing and lens are inside a small bag with the letter "L" marked on it.

49/02 Fit the sidelight to the body, being careful not to damage the components.



49/03 Fit the indicator housing into position, as shown in the photo...

49/04 ... then fit the left indicator lens to the housing to hold both parts in place.



Stage 49: Sidelights and Indicators



49/05 Repeat these steps to fit the second sidelight and the components for the right indicator, which are contained in a small bag marked "R".

49/06 Next place the two sets of wires on your work surface. The set of wires with the red connector is for the left indicator, the set with the black connector is for the right indicator.



49/07 Working from inside the body, and making sure the sets of wires correspond to the correct side, insert the LED lights into the holes. Using a pair of tweezers to ensure you don't damage the components, bend the lights as shown in the round photo. Do not force them into the holes, you can use a small drop of PVA glue if necessary.

Stage 49: Sidelights and Indicators

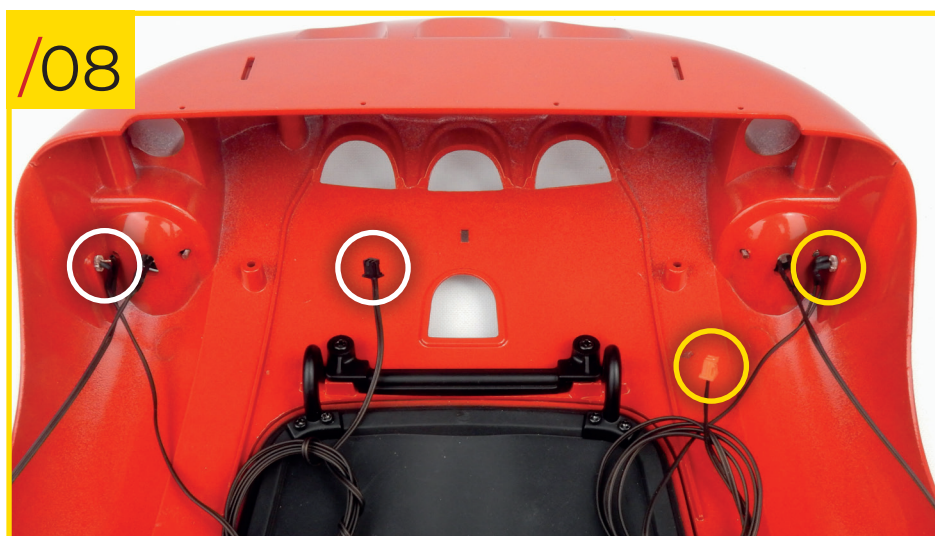

49/08 Look at the photo to check that you've fitted the two sets of wires correctly.



STAGE 49 IS COMPLETE
Here's how the front section of the body looks at the end of this stage.

Stage 50: Fog Lights and Front Grille

In this stage you'll fit the fog lights and front grille to the body.



STAGE 50 PARTS LIST

Name
1 Front grille
2 Left fog light housing
3 Right fog light housing
4 Fog light lenses

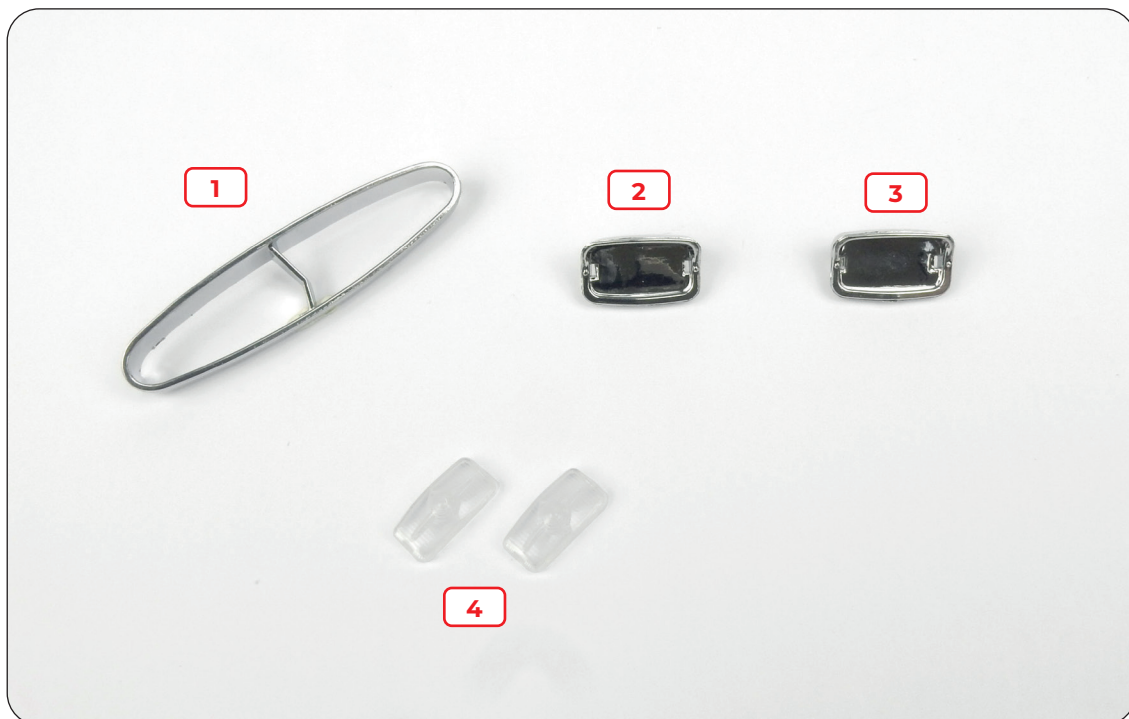

Stage 50: Fog Lights and Front Grille



50/01 Place the front section of the body on a soft surface along with the front grille that you received with this stage. Fit the grille in place.

50/02 Look at the photo to check that you've fitted the pieces together correctly.



50/03 Now place the two fog light housings on your work surface. The housing with the letter "L" marked on it goes on the left, the one with letter "R" goes on the right.

Stage 50: Fog Lights and Front Grille

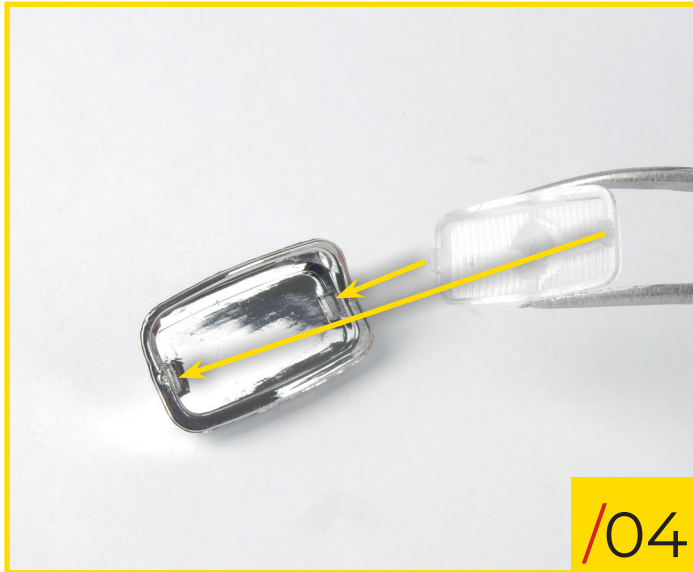

50/04 Fit the fog light lenses to the two housings.

/04



/05

50/05 Here's how the two fog lights look once they've been correctly fitted.



/06

50/06 Now fit the left fog light into its position on the front of the body, as shown.

Stage 50: Fog Lights and Front Grille



50/07 Do the same for the right fog light.



STAGE 50 IS COMPLETE
Here's how the front section of the body looks at the end of this assembly phase.

Stage 51: Air Intake Covers and Ferrari Badge

In this stage you'll add the air intake covers and Ferrari badge to the front of the body.



STAGE 51 PARTS LIST

Name
1 Lower air intake covers
2 Upper air intake cover
3 Ferrari badge

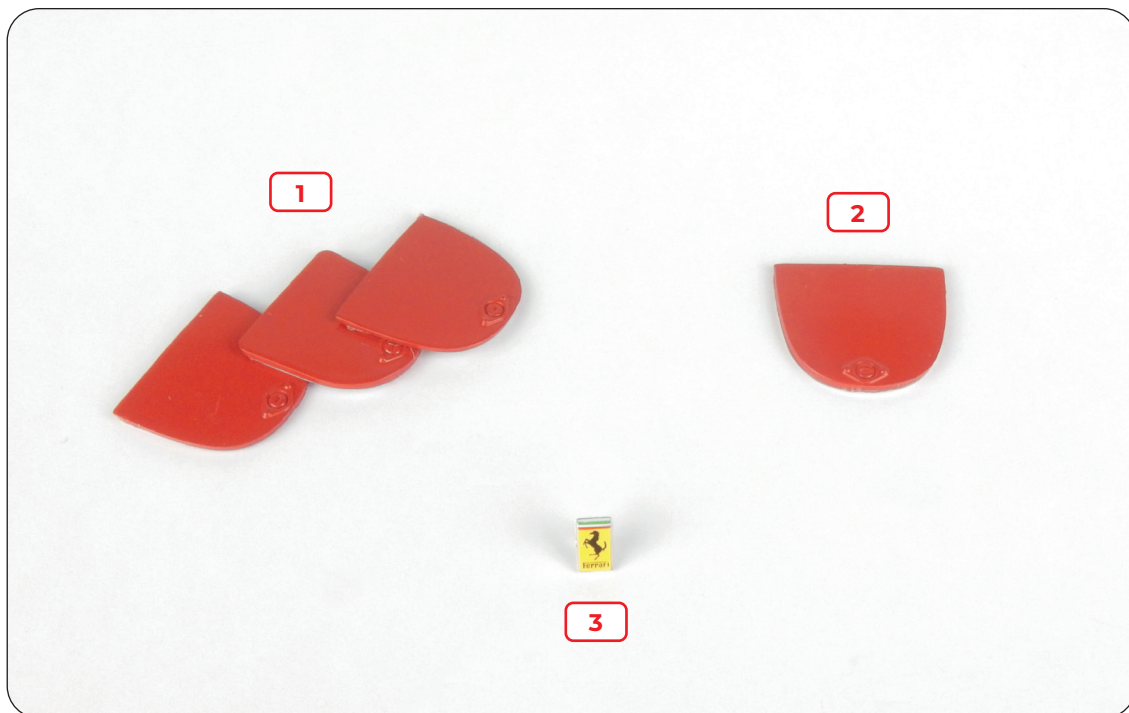

Stage 51: Air Intake Covers and Ferrari Badge



51/01 Place the air intake covers on your work surface and orientate them as shown. The upper cover isn't quite as wide as the others, whilst the lower covers have letters imprinted on their inner sides. These will help to ensure you fit them into the correct positions.

51/02 First, remove the backing from the double-sided tape on the edge of the upper cover.

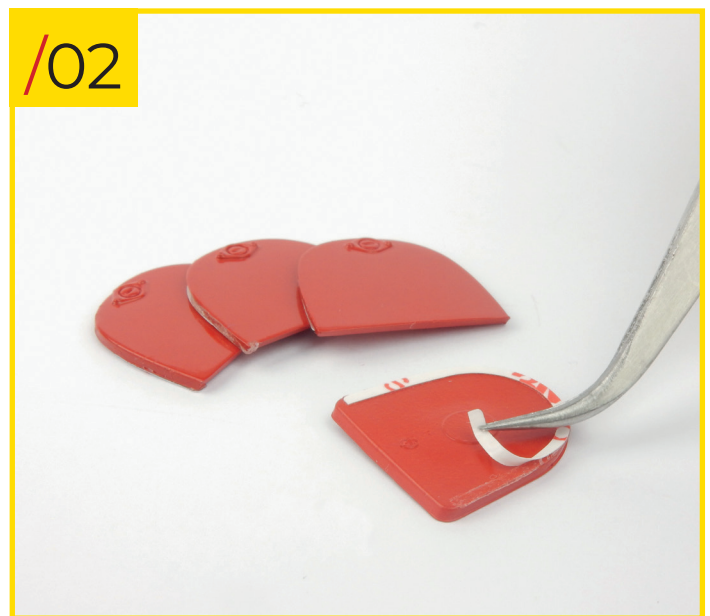

51/03 Fit the upper air intake cover to the front of the body, as shown.

Stage 51: Air Intake Covers and Ferrari Badge

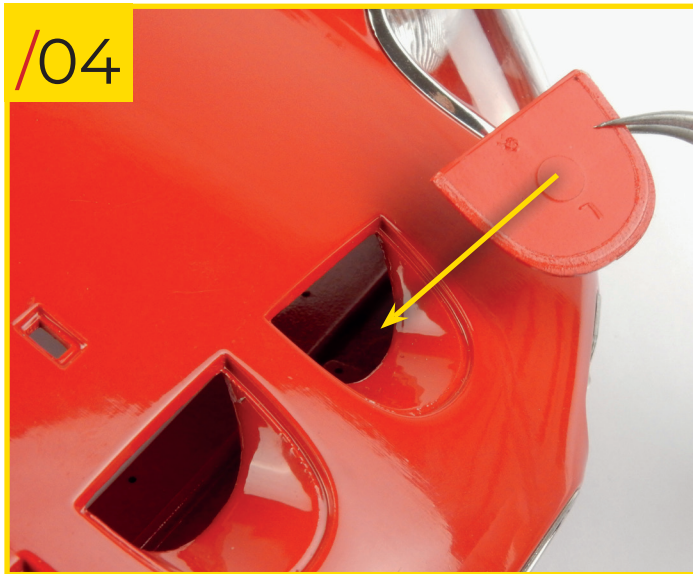

51/04 Now remove the backing from the lower cover with an "L" on it and fit it to the body, as shown.

51/05 Repeat these steps to fit the one with an "M"...



51/06 ... and then the one with an "R".

Stage 51: Air Intake Covers and Ferrari Badge



51/07 Finally, push the Ferrari badge into its position, orientating it as shown.



STAGE 51 IS COMPLETE
Here's how the front section of your model's body looks at the end of this assembly phase.

Stage 52: Hot Air Ducts

In this stage you'll fit the engine's hot air ducts to the front section of your model's body.



STAGE 52 PARTS LIST

Name	Name
1 Left primary duct	7 type C screws
2 Right primary duct	
3 Left secondary duct	
4 Right secondary duct	

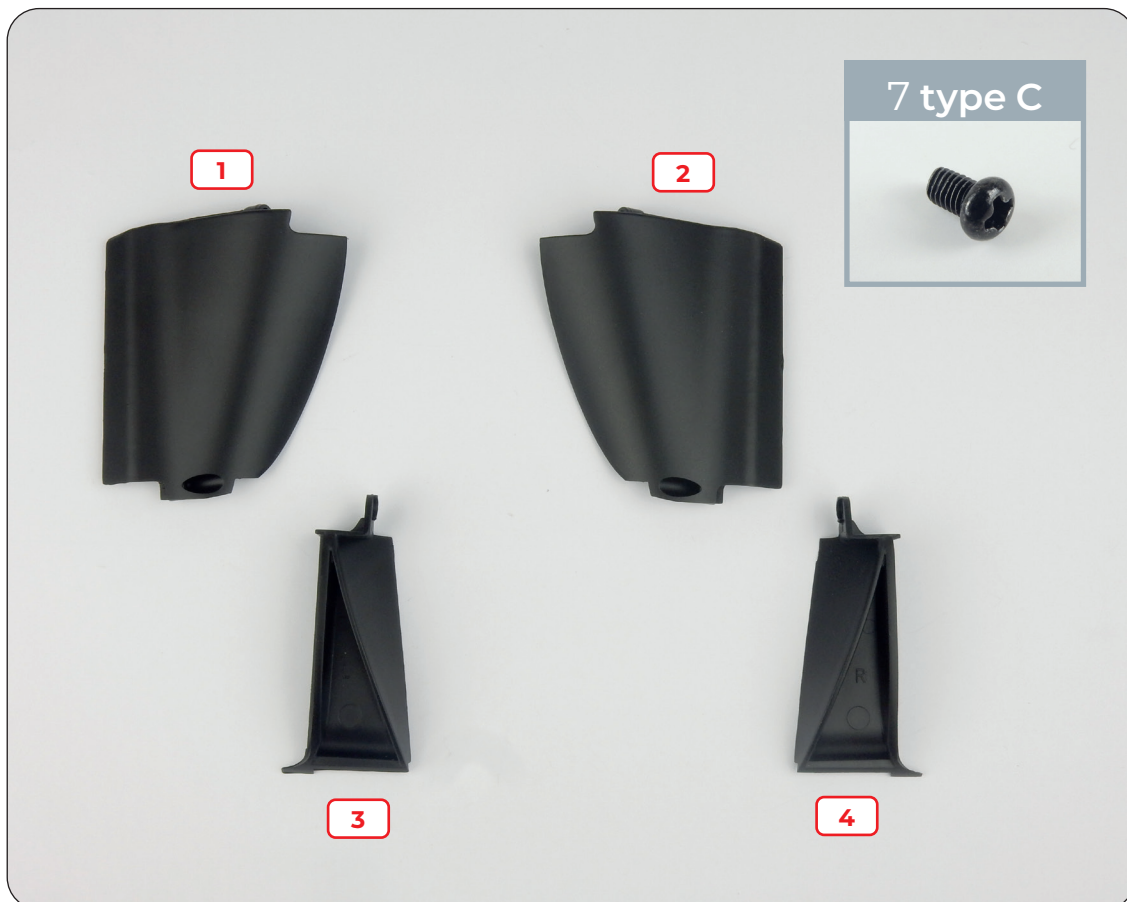

Stage 52: Hot Air Ducts



52/01 Place the front section of the body on a soft surface, along with the left primary duct and the left secondary duct.

52/02 Working on the inside of the body, fit the left primary duct, orientating the pieces as shown.



52/03 Secure the pieces together using two type C screws.

Stage 52: Hot Air Ducts



52/04 Fit the left secondary duct to the body and secure the pieces together with another type C screw.



52/05 Now fit the right primary duct, orientating the pieces as shown in the photo.



52/06 Screw two type C screws into the holes indicated to secure the pieces together.

Stage 52: Hot Air Ducts



52/07 Finally, fit the right secondary duct to the body and secure it using another type C screw.



STAGE 52 IS COMPLETE
Here's how the front section of your model's body looks after the engine's hot air ducts have been fitted.

Stage 53: The Bonnet Locking System (Part 1)

In this stage you'll start fitting the first set of components for your model's bonnet locking system.



STAGE 53 PARTS LIST

Name	Name
1 Latch receivers	2 type I screws
2 Spring	
3 Latch	
4 Strap	
5 Buckle	

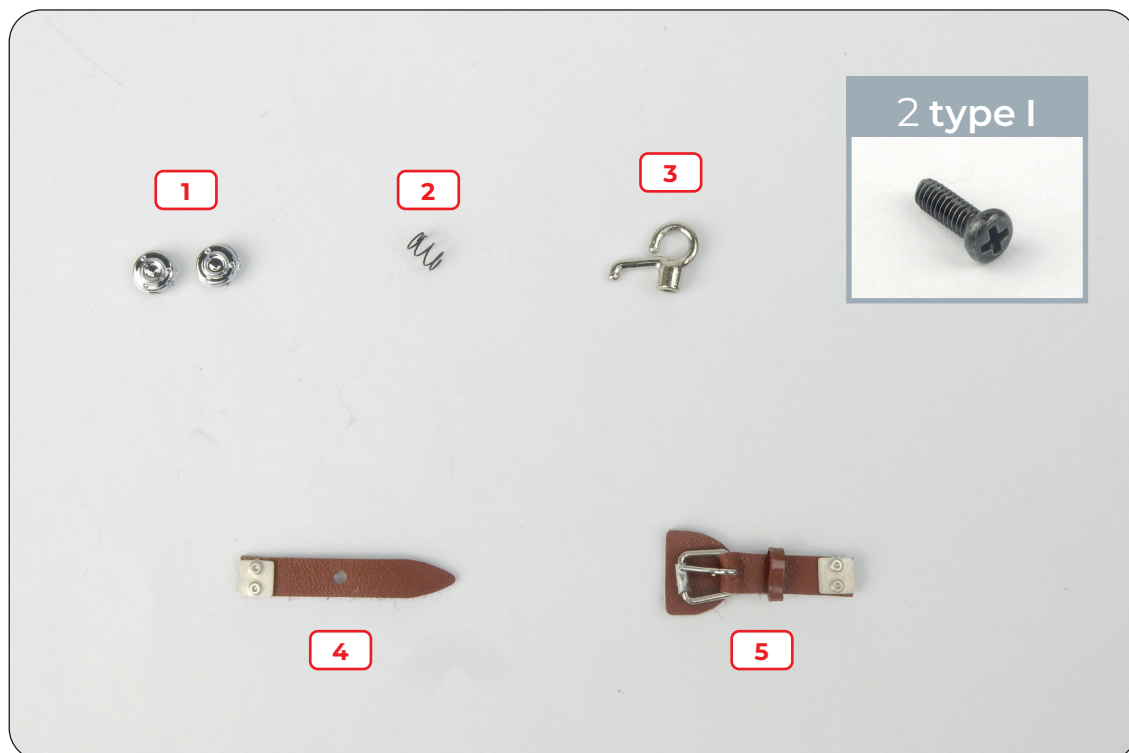

Stage 53: The Bonnet Locking System (Part 1)

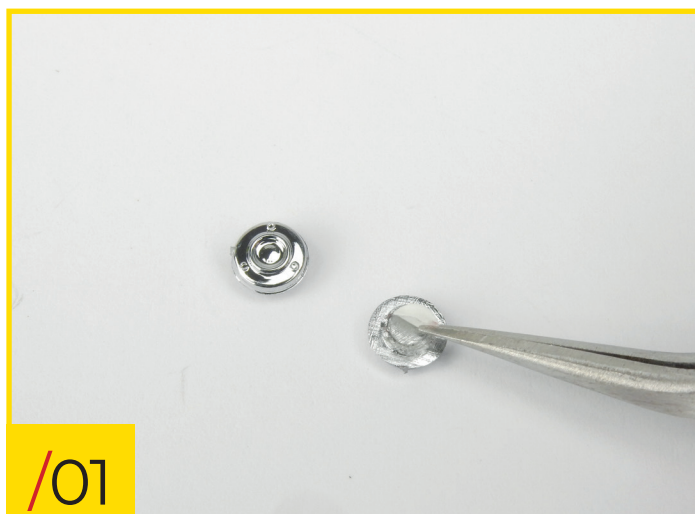

53/01 Remove the piece of protective paper from the underside of the two latch receivers.



53/02 Working on the left side of the body's front section, insert the two receivers into their slots on the body and bonnet, orientating the pieces as shown. You can use a drop of PVA glue if necessary.



53/03 Now slide the spring onto one of the type I screws.

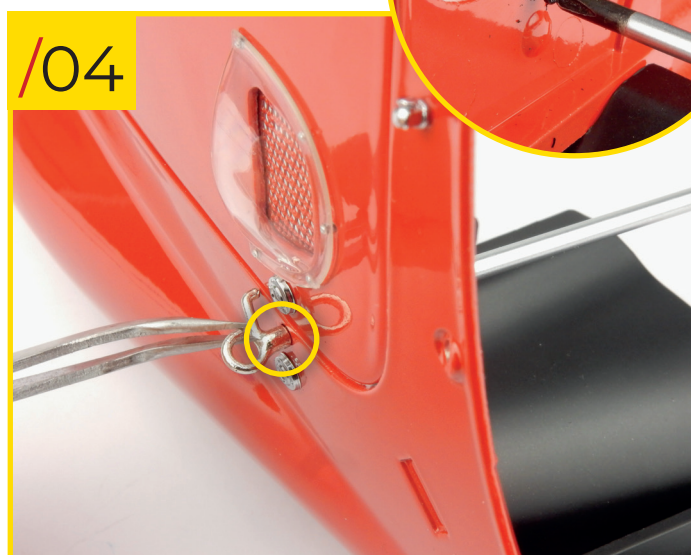
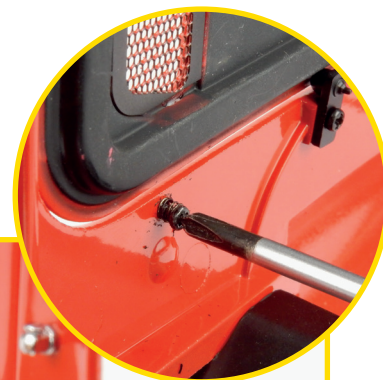

53/04 Insert the latch into the hole in the body that's between the two receivers. To secure it in place, screw the screw (with the spring) into the corresponding hole in the underside of the body. Put the latch's hook into the receiver you fitted to the bonnet. Don't overtighten the screw.

Stage 53: The Bonnet Locking System (Part 1)



/05

53/05 Insert the strap into the buckle, orientating the pieces as shown.

53/06 Remove the piece of protective paper from the underside of the buckle.

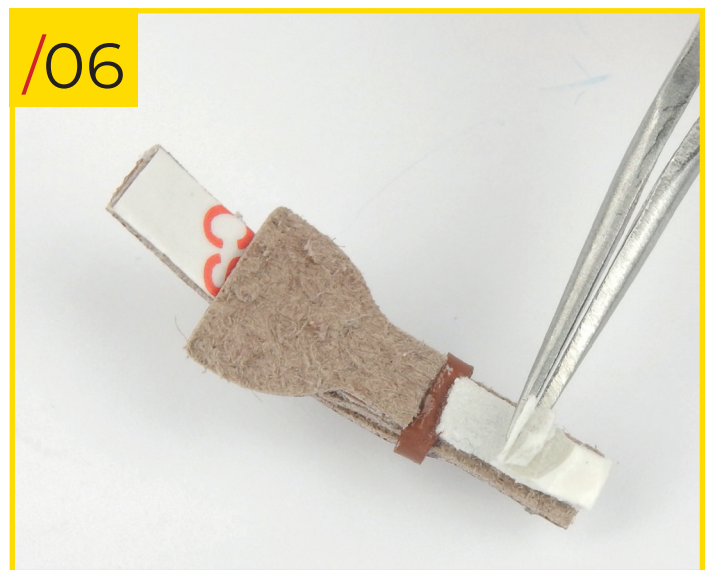

/06



/07

53/07 Place the underside of the buckle into the slot on the body.

53/08 Now remove the piece of protective paper from the underside of the strap.



/08

Stage 53: The Bonnet Locking System (Part 1)



53/09 Stick the strap to the bonnet. When the model is finished, the bonnet can be opened by releasing the strap from the buckle and rotating the latch.



STAGE 53 IS COMPLETE
The first set of components for your model's bonnet locking system have now been fitted.

Stage 54: The Bonnet Locking System (Part 2)

In this stage you'll complete your model's bonnet locking system by fitting the components to the right of the body.



STAGE 54 PARTS LIST

Name	Name
1 Latch receivers	2 type I screws
2 Spring	
3 Latch	
4 Buckle	
5 Strap	

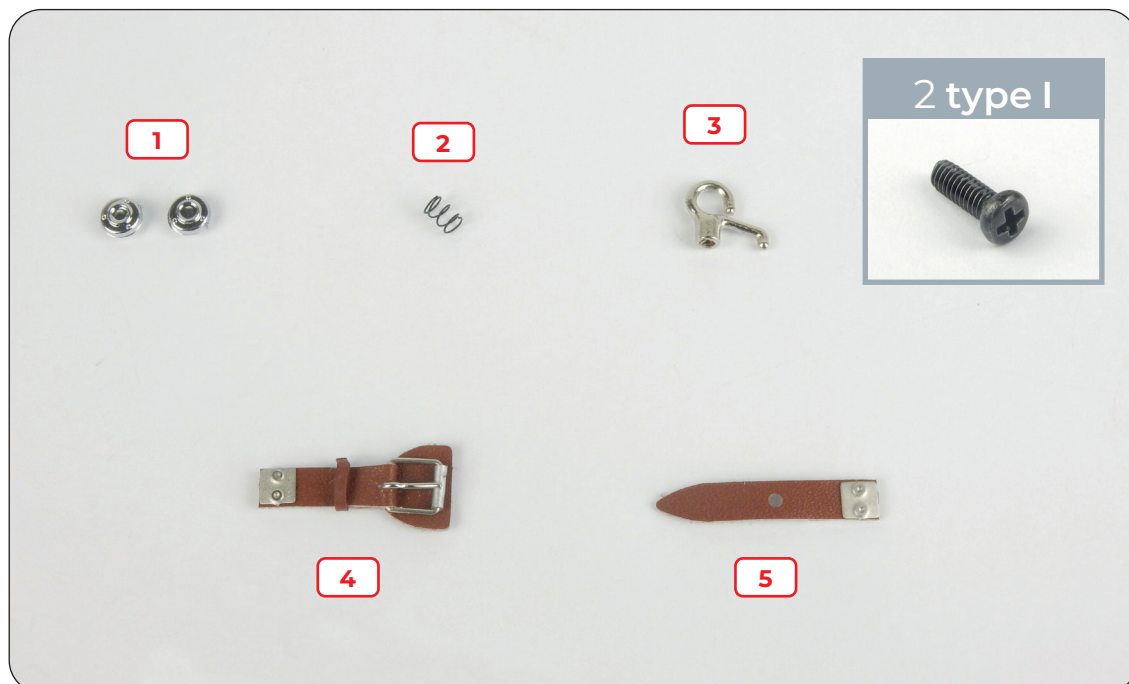

Stage 54: The Bonnet Locking System (Part 2)

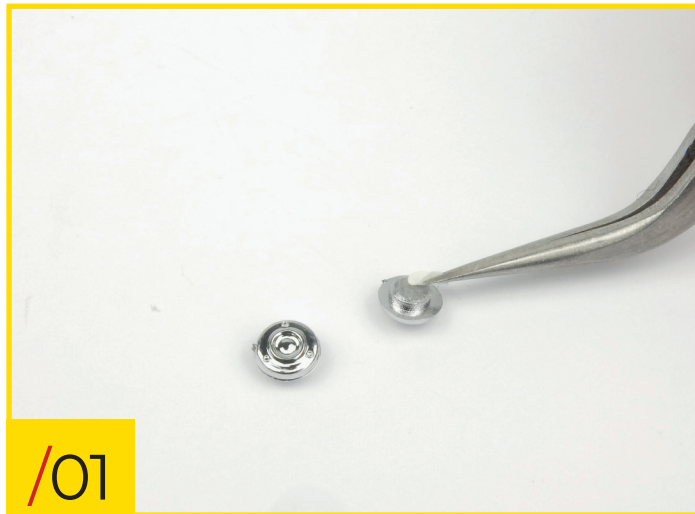

54/01 Remove the piece of protective paper from the underside of the two latch receivers.

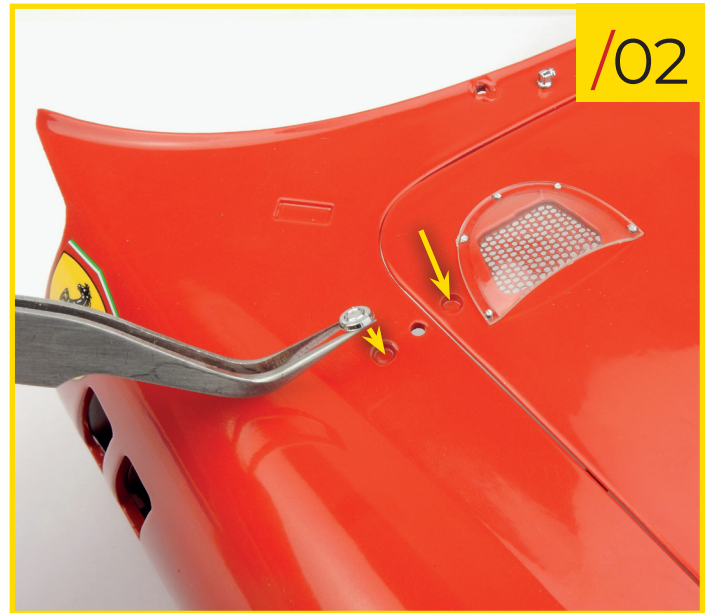

54/02 Insert the two receivers into their slots on the right side of the body and bonnet, orientating the pieces as shown.



54/03 Slide the spring onto one of the type I screws.

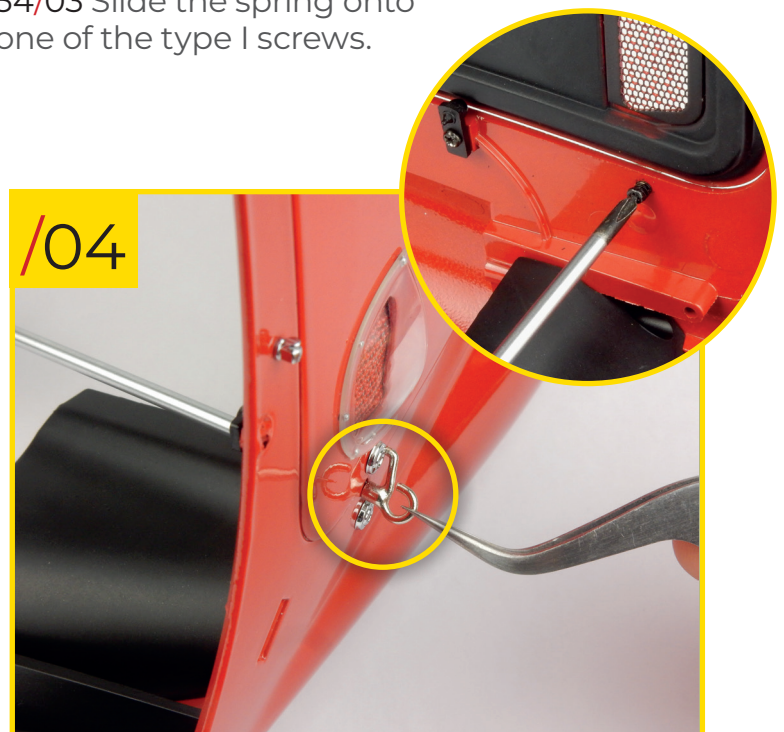

54/04 Insert the latch into the hole in the body that's between the two receivers. To secure it in place, screw the screw (with the spring) into the corresponding hole in the underside of the body. Put the latch's hook into the receiver you fitted to the bonnet.

Stage 54: The Bonnet Locking System (Part 2)



54/05 Insert the strap into the buckle, orientating the pieces as shown.

54/06 Remove the piece of protective paper from the underside of the buckle.

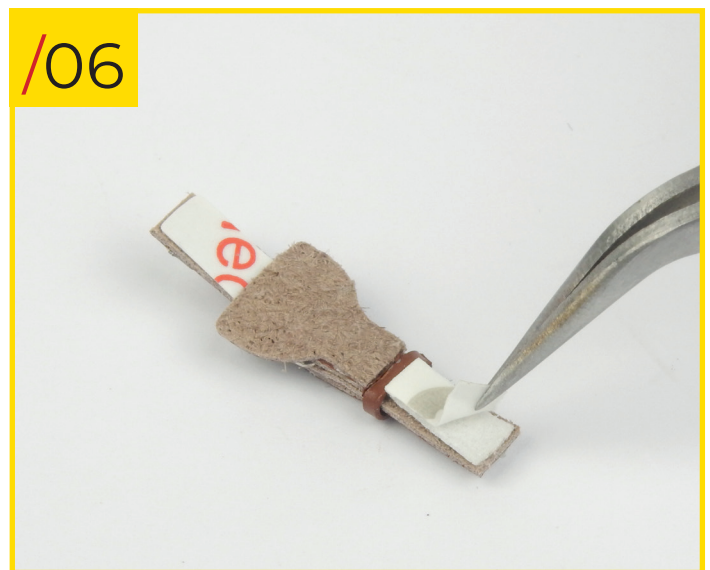

54/07 Place the buckle into its slot on the right side of the body.

54/08 Remove the piece of protective paper from the underside of the strap.



Stage 54: The Bonnet Locking System (Part 2)

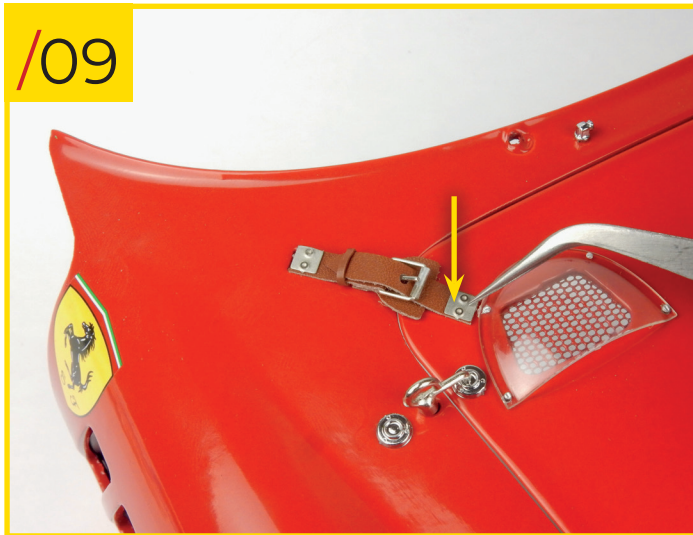

54/09 To complete this assembly phase, stick the strap to the bonnet.



STAGE 54 IS COMPLETE
The bonnet locking system is now complete. When you want to open the bonnet to reveal your model's engine, simply release the straps from the buckles and rotate the latches.

Stage 55: The Front Left Suspension (Part 1)

In this stage you'll start working on the front left suspension.



STAGE 55 PARTS LIST

Name	Name
1 Stub axle	2 type C screws
2 Upper arms	2 type J screws
3 Shock absorber	

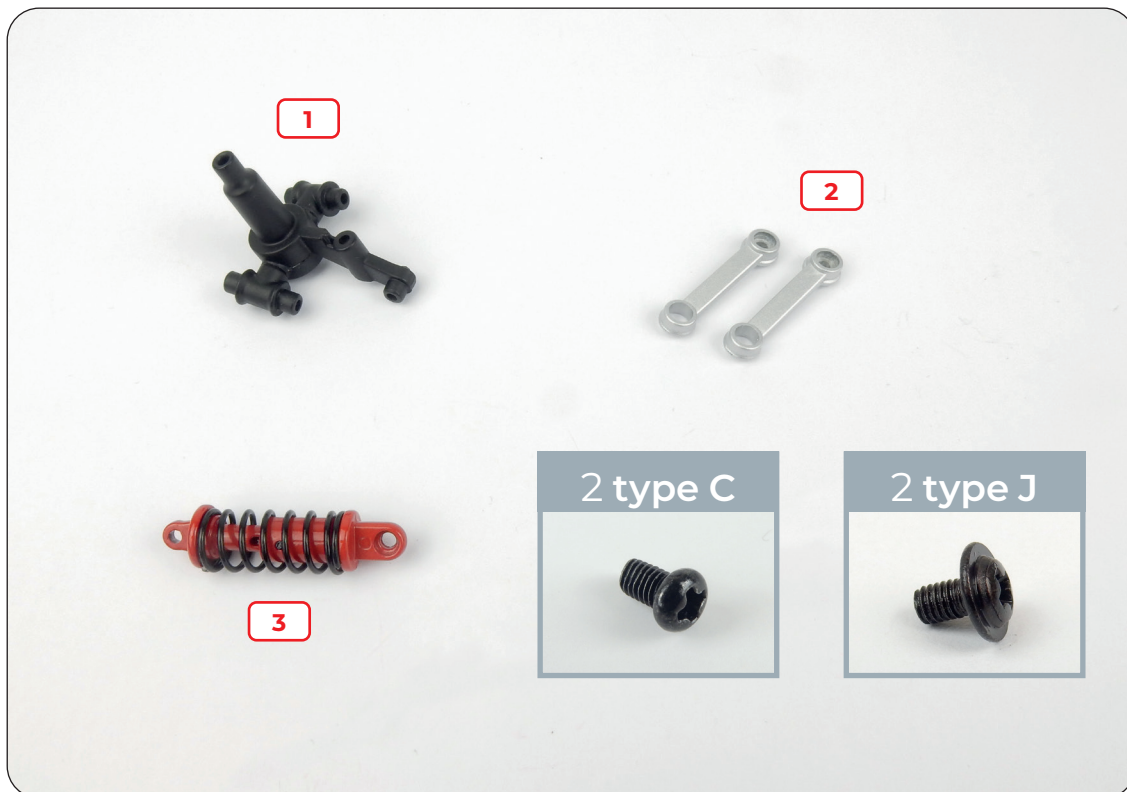

Stage 55: The Front Left Suspension (Part 1)

/01

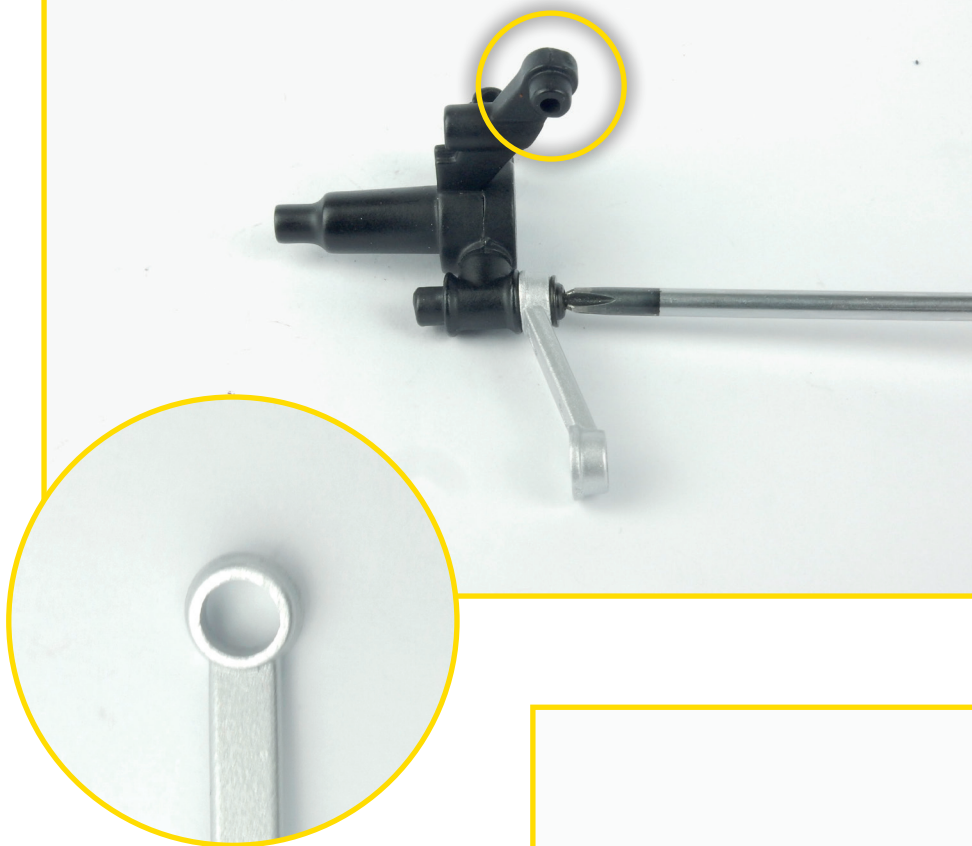

55/01 Fit one of the upper arms to the stub axle, orientating the pieces as shown. Use the stud highlighted by the circle in the photo as a reference for the orientation of the stub axle. The holes at the ends of the arms aren't identical: for this step you'll need to use the end with the larger hole (shown in the round photo). Secure the pieces together using a type J screw.

/02



55/02 Fit the second upper arm to the stub axle, being very careful to ensure you orientate the pieces as shown in the photo.

Stage 55: The Front Left Suspension (Part 1)

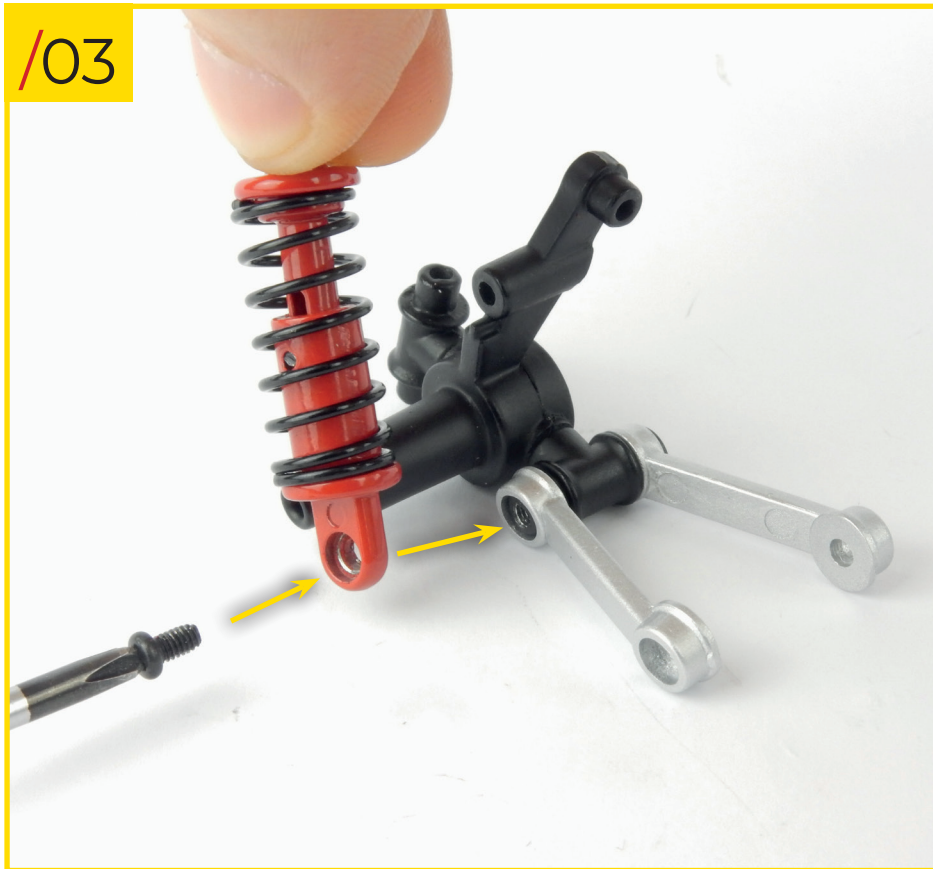

55/03 Now fit the longer end of the shock absorber to the rest of the assembly, then secure everything together using a type C screw.



STAGE 55 IS COMPLETE
Here's how the front left suspension assembly looks at the end of this session.

Stage 56: The Front Left Suspension (Part 2)

In this stage you'll continue assembling your model's front left suspension.



STAGE 56 PARTS LIST

Name	Name
1 Connecting mount	6 Fork bracket
2 Spring	
3 Spring support	5 type B screws
4 Lower arm A	2 type C screws
5 Lower arm B	3 type J screws

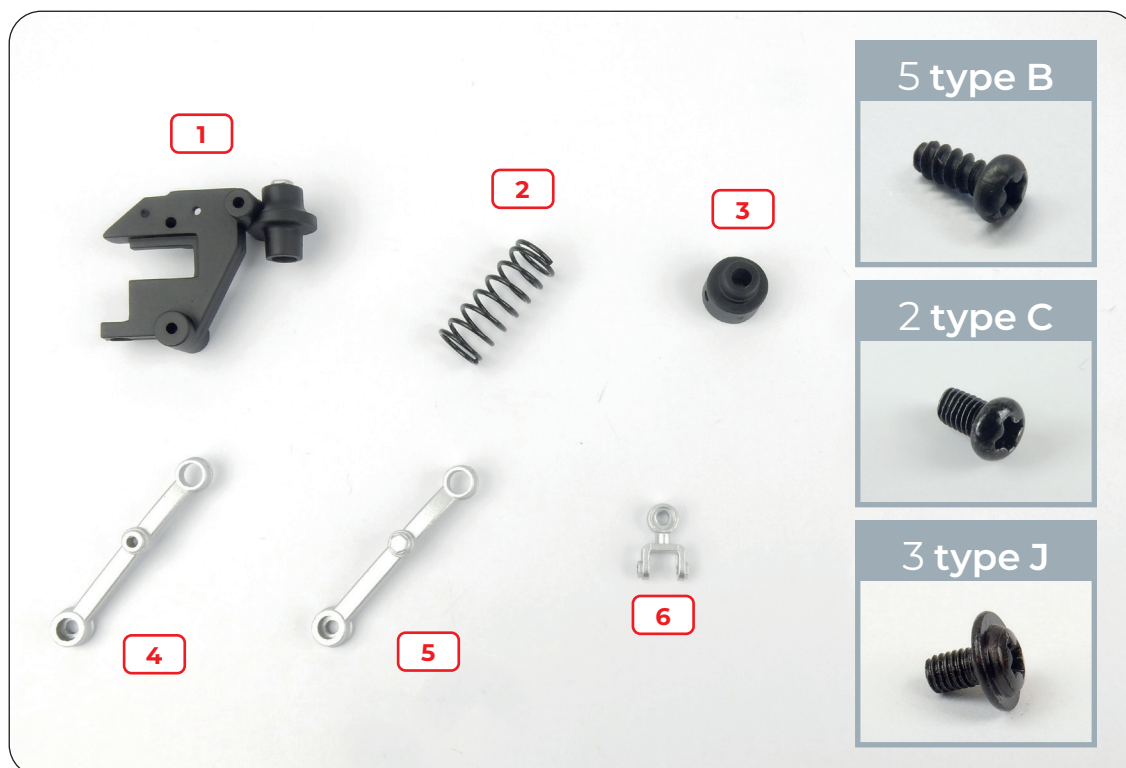

Stage 56: The Front Left Suspension (Part 2)



56/01 Place the suspension assembly you worked on in stage 55 and the connecting mount on your work surface. Orientate the pieces as shown and secure them together by screwing two type B screws into the holes indicated.

56/02 Slide one end of the spring over the central stud on the mount and push the spring support into the other end of the spring.

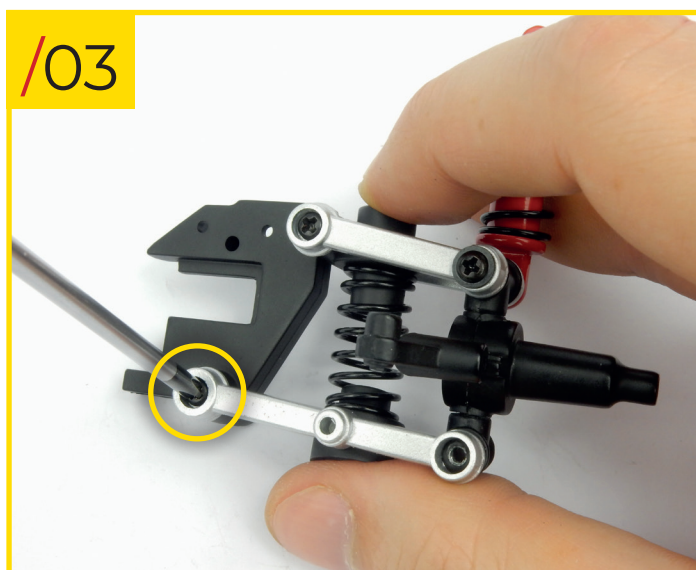
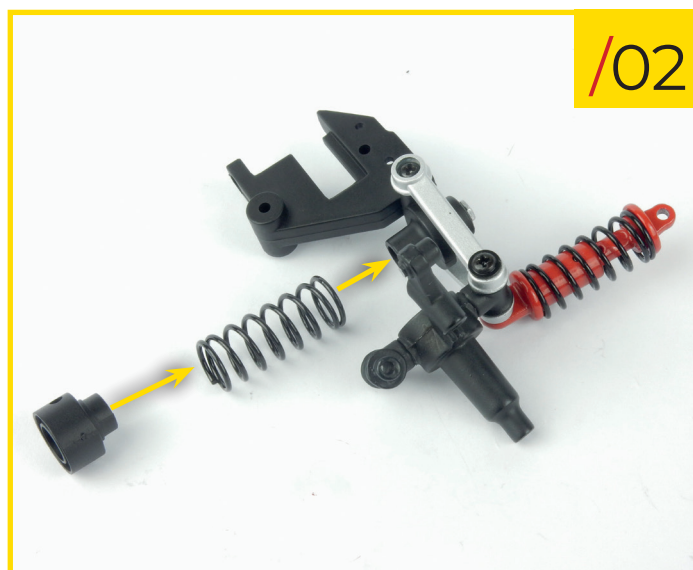

56/03 Connect the lower arm A (which has a central hole) to the rest of the assembly, orientating the pieces as shown. The longer end of the arm needs to be fitted to the mount; the shorter end goes to the stub axle. Screw a type B screw into the hole indicated.

Stage 56: The Front Left Suspension (Part 2)

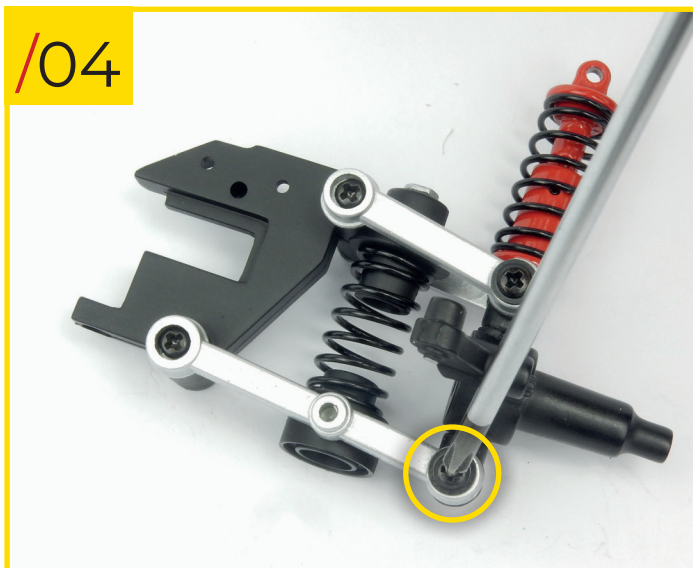

56/04 Secure the arm to the stub axle using a type J screw.

56/05 Make sure that the stud on the centre of the arm goes into one of the side holes in the spring support. Position the fork bracket so that it lines up with the arm's central hole, then secure the pieces together by screwing a type C screw into the hole indicated.

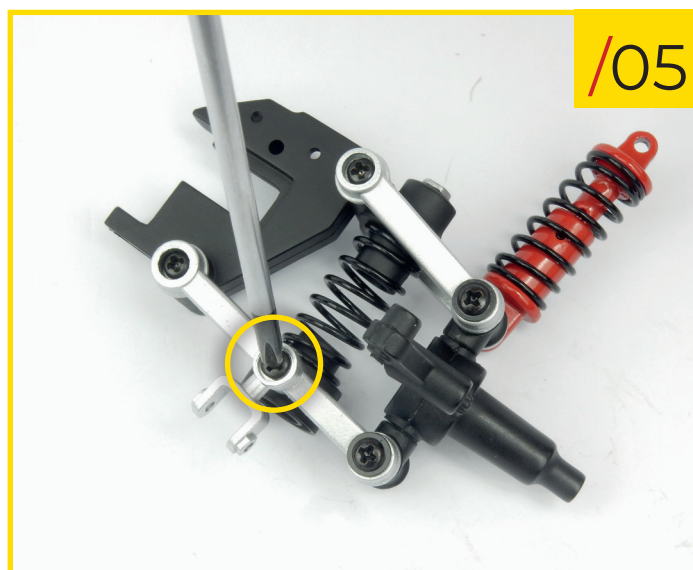

56/06 Working on the other side of the assembly, fit the lower arm B (the one without a central hole). Ensure that the longer end of the arm goes towards the mount, and the shorter end towards the stub axle, then insert the stud on the centre of the arm into the other side hole in the spring support. Screw a type B screw into the hole indicated by a circle in the photo.

Stage 56: The Front Left Suspension (Part 2)



56/07 Screw a type J screw into the hole indicated to secure the arm to the stub axle.



STAGE 56 IS COMPLETE
Here's how the front left suspension assembly looks at the end of this session. Keep it somewhere safe together with the other pieces.