

THE SPY WHO LOVED ME™

LOTUS
esprit



Pack 11

BUILD INSTRUCTIONS

STAGE 084: ATTACHING THE RUDDERS

STAGE 089: FITTING THE REAR
LEFT LIGHTS

STAGE 085: ATTACHING THE
PROPELLER GUARD

STAGE 090: INSTALLING THE COCKPIT
AND CHASSIS

STAGE 086: ATTACHING THE PROPELLERS

STAGE 091: INSTALLING THE
REAR VALANCE

STAGE 087: BUILDING THE REAR
NUMBER PLATE

STAGE 092: PREPARING THE FRONT RIGHT
HYDROPLANE FIN

STAGE 088: FITTING THE REAR
RIGHT LIGHTS

THE SPY WHO LOVED ME © Danjaq, LLC and Metro-Goldwyn-Mayer Studios Inc. THE SPY WHO LOVED ME, *007*™ and related James Bond Indicia © 1962-2024 Danjaq, LLC and Metro-Goldwyn-Mayer Studios Inc. THE SPY WHO LOVED ME, *007*™ and related James Bond Trademarks are trademarks of Danjaq, LLC. All Rights Reserved. Produced under licence from Group Lotus LTD. LOTUS, the Lotus Roundel, car names and all associated logos and distinctive designs are trade marks of Group Lotus LTD.

Advice from the experts

Spare screws are included with each part. Occasionally, you may be instructed to keep spare or unused screws for a later stage. Keep these spares in a safe place and label them correctly.

Please make sure you don't mix up the screws. They look quite similar, but the threads do vary slightly. Using the wrong screws may damage the parts.

When securing parts together using multiple screws, fit each screw loosely to ensure all the parts are correctly aligned before gently tightening them firmly, but not overtight, in the order in which you placed them.

The screwdriver can be magnetized by stroking it with a magnet (fridge magnet, etc.) enabling it to hold the screws and make assembly easier.

If a screw is tight going into a metal part, do not force it as you may shear the head off. Remove it and put a tiny smear of Vaseline, soap or light oil on the thread. That will lubricate it and make it easier to drive home.

During the course of this build, you will receive many pieces that you will assemble immediately – following the instructions in the corresponding stage – and other pieces that you should store safely to one side, for use in future assembly stages.

Left and Right! When building your *The Spy Who Loved Me* Lotus Esprit, the left- or right-hand side refers to that side as if you are sitting in the car.



WARNING: Some parts are assembled using magnets. These magnets can cause serious injury if they are swallowed. Keep away from children. If you suspect a magnet has been swallowed, seek medical help straight away.

Stage 084: Attaching the Rudders

In this stage you'll attach the rudders to the rear bumper.

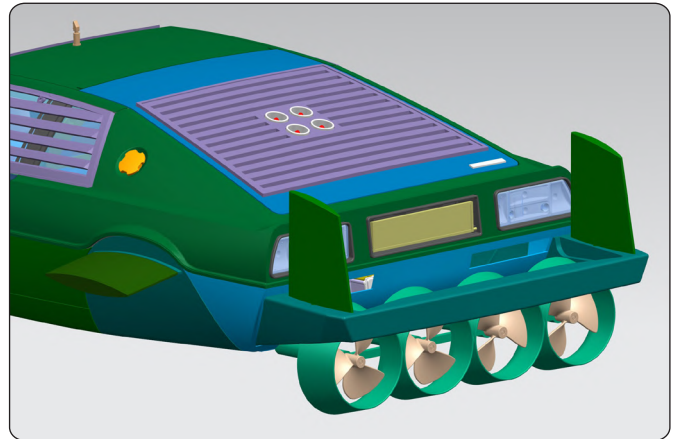

STAGE 084 PARTS LIST

Name
84-A Rear bumper
84-B Rear bumper cover
84-C Cover (L)
84-D Cover (R)
PS05 screws x3



Stage 084: Attaching the Rudders



Place the left rudder (stage 083) onto the rear bumper (84-A).



Screw the parts together with a PS05 screw.



Take the covers (84-C and 84-D), which are marked 'L' for left and 'R' for right (circled).

Stage 084: Attaching the Rudders



Press the left cover into the assembly.



The left rudder should now look like this.



Place the right rudder (stage 083) onto the other side.



Secure with a PS05 screw.

Stage 084: Attaching the Rudders



Press the right cover into the assembly.



The right rudder should now look like this.



Stage 085: Attaching the Propeller Guard

In this stage you'll attach the propeller guard to the rear bumper. You'll also insert the propeller motors and connect their cables.

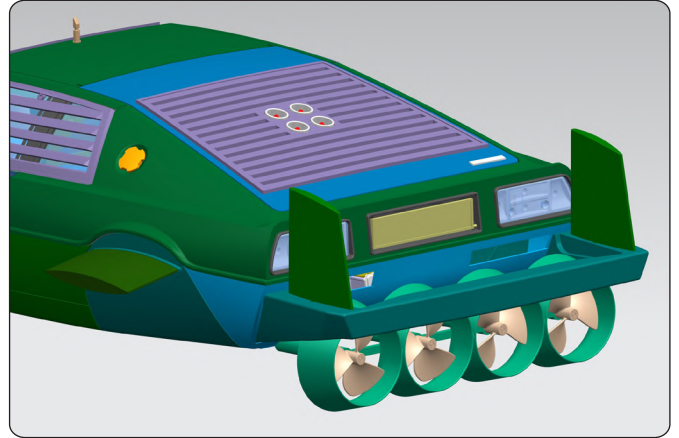

STAGE 085 PARTS LIST

Name
85-A Propeller guard
85-B Propeller motor x4
85-C Motor connector (No. 12) x2
PS05 screws x6



Stage 085: Attaching the Propeller Guard

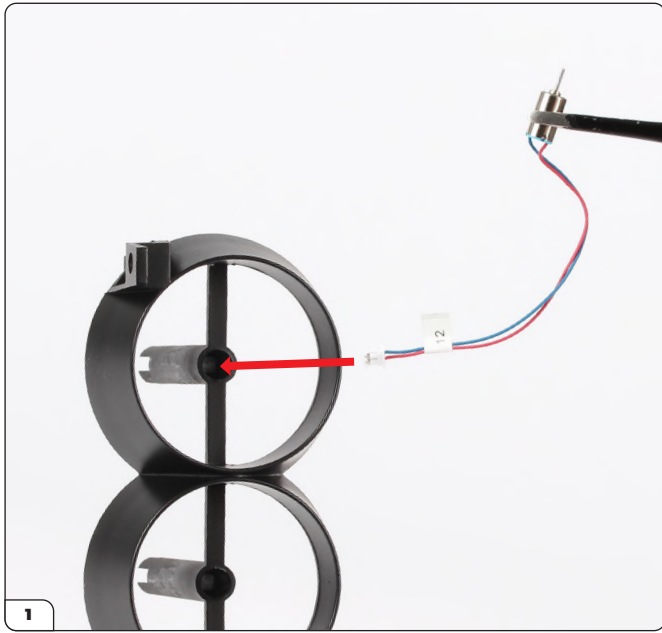

Thread the cable of a propeller motor (85-B) through the propeller guard (85-A).

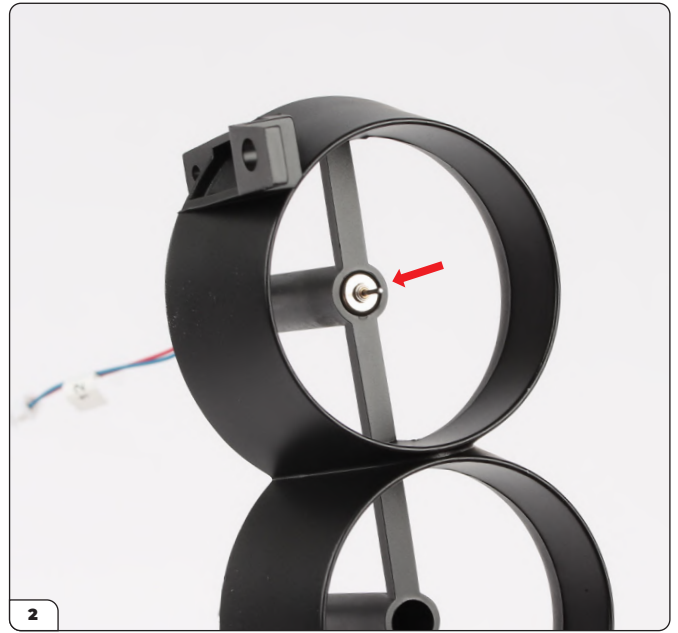

Press the motor into the propeller guard.



Repeat this process for the other three motors.

Stage 085: Attaching the Propeller Guard

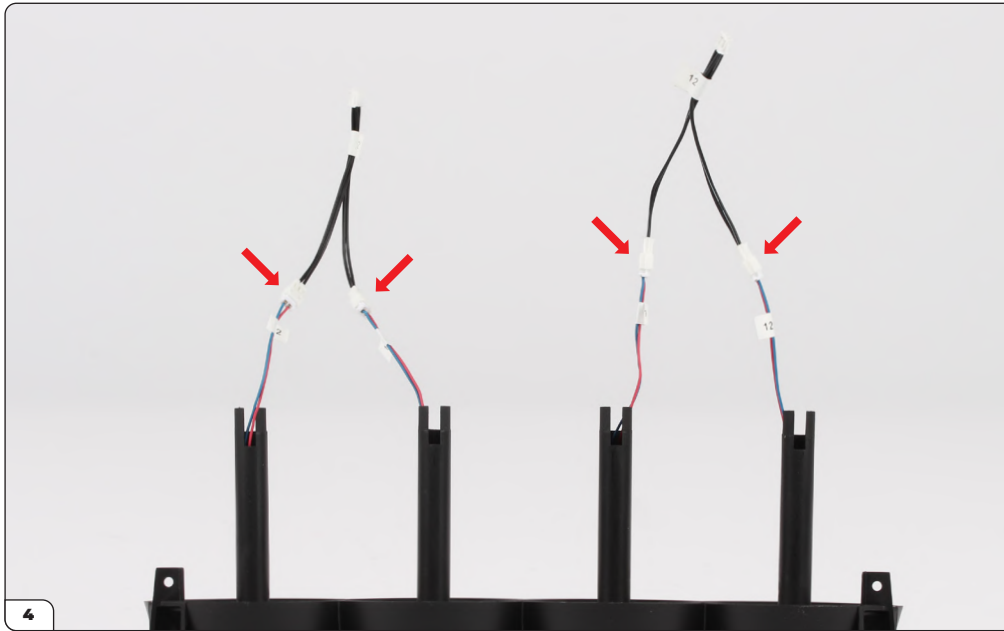

Connect the motor connectors (85-C) to the cables as shown.



Press the assembly onto the rear bumper (stage 084).

Stage 085: Attaching the Propeller Guard



Secure the parts together with 2x PS05 screws. Make sure that the tops of the two screw posts in the tail plane assembly are flush with the tops of the tabs in the rear of the propeller guard (6b).



Press the rear bumper cover (84-B) onto the assembly.

Stage 085: Attaching the Propeller Guard

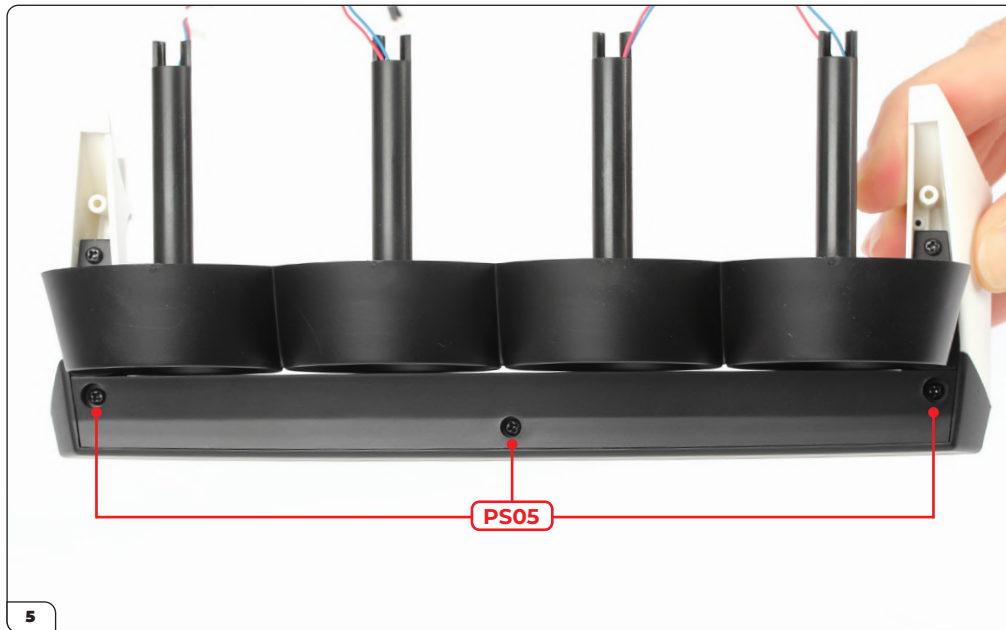

Secure with 3x PS05 screws.



Stage 086: Attaching the Propellers

In this stage you'll attach the propellers to the motors.

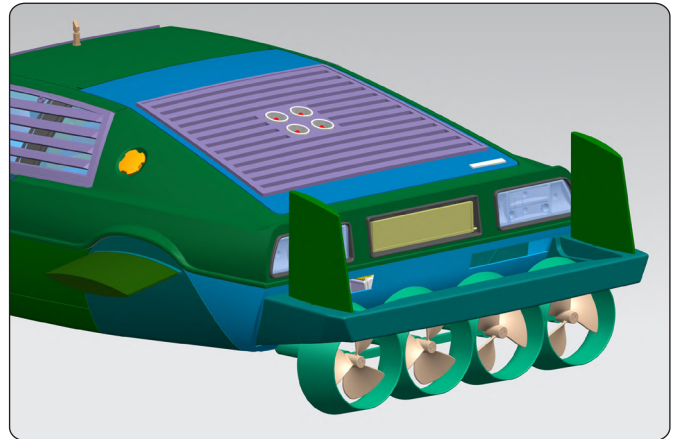

STAGE 086 PARTS LIST

Name
86-A Propeller x4
86-B Panel (L)
86-C Panel (R)
PS02 screws x3

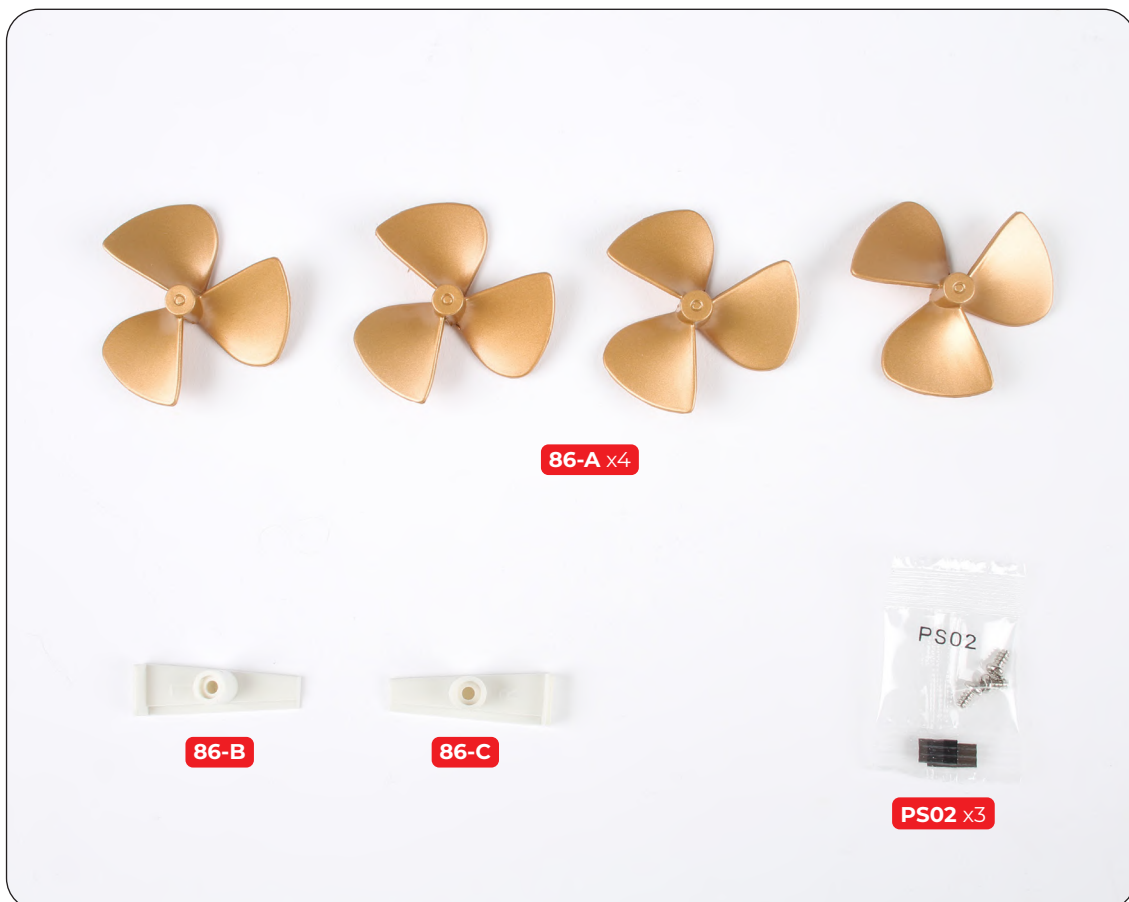

Stage 086: Attaching the Propellers

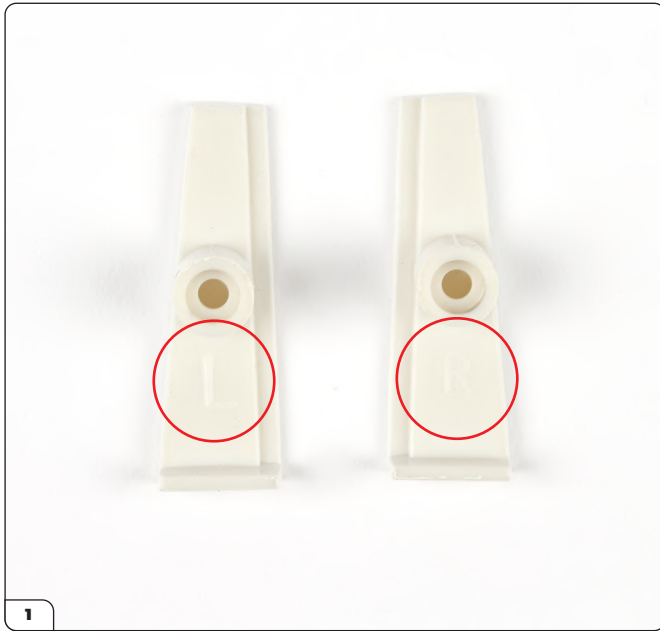

Take the panels (86-B and 86-C), which are marked 'L' for left and 'R' for right (circled).

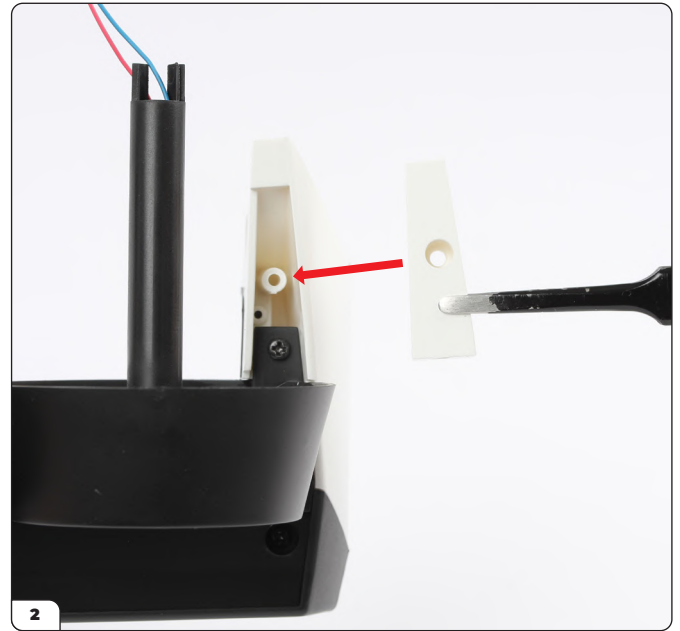

Press the left panel onto the underside of the left rudder (stage 085).

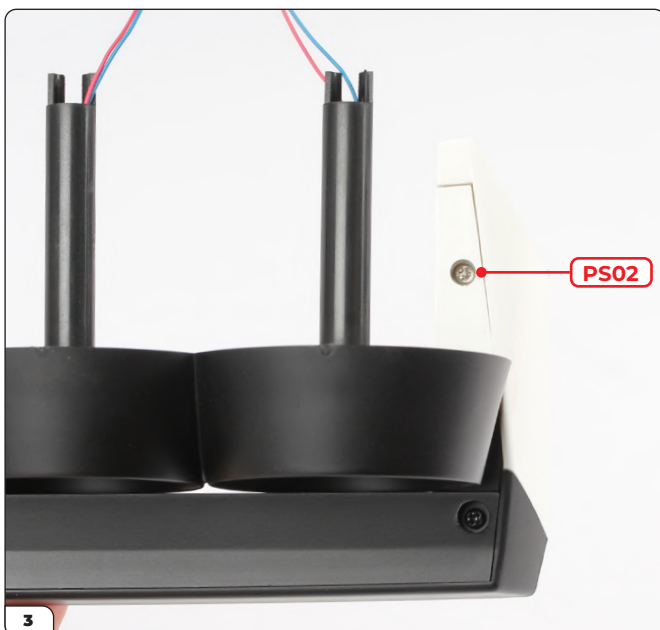

Secure with a PS02 screw.

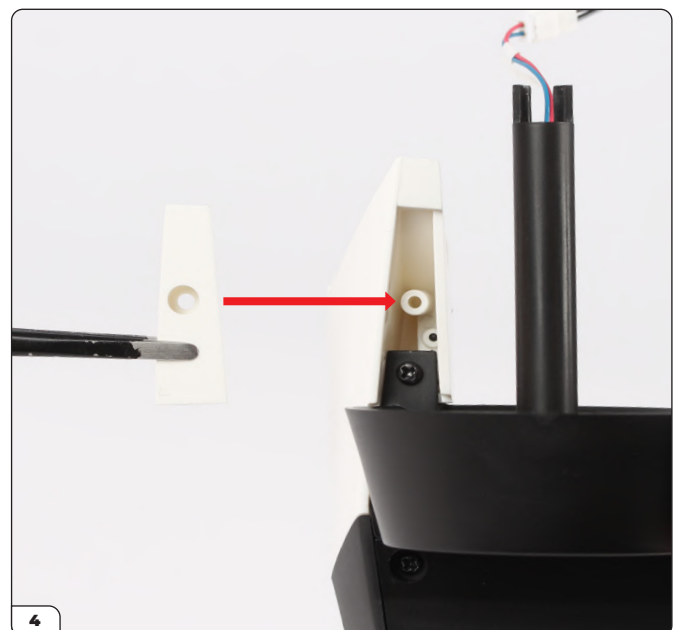

Press the right panel onto the underside of the right rudder.

Stage 086: Attaching the Propellers

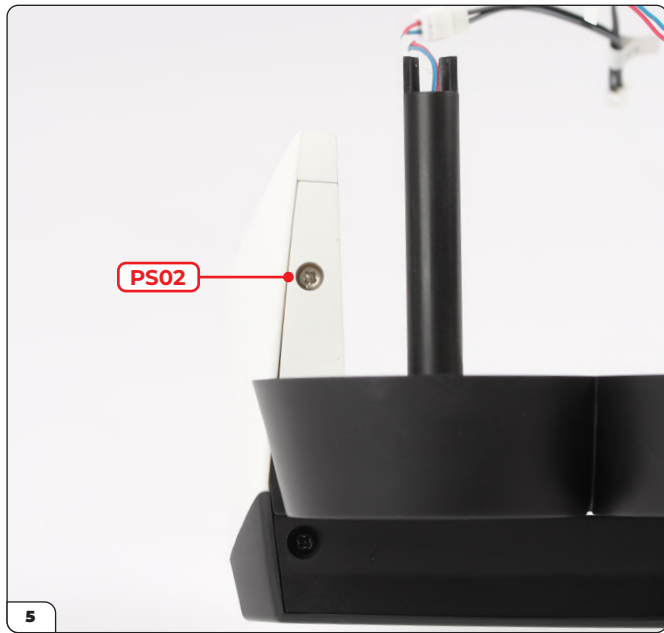

Secure with a PS02 screw.

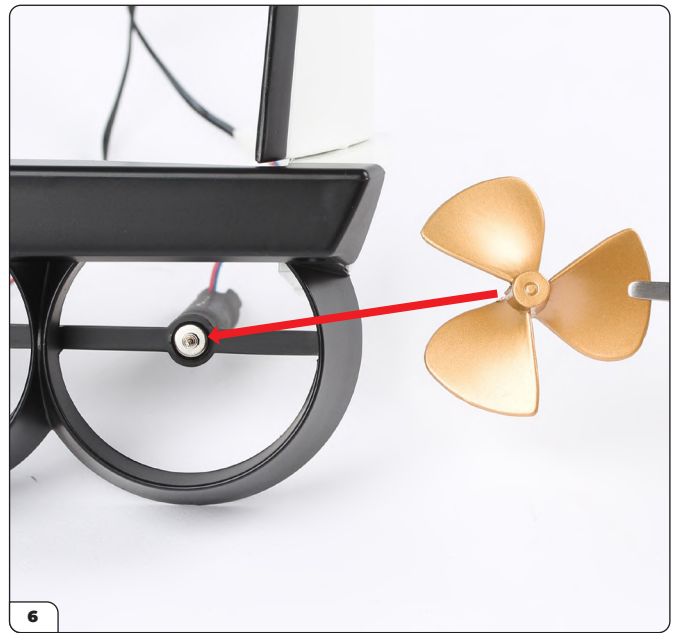

Press a propeller (86-A) onto the pin of a motor.

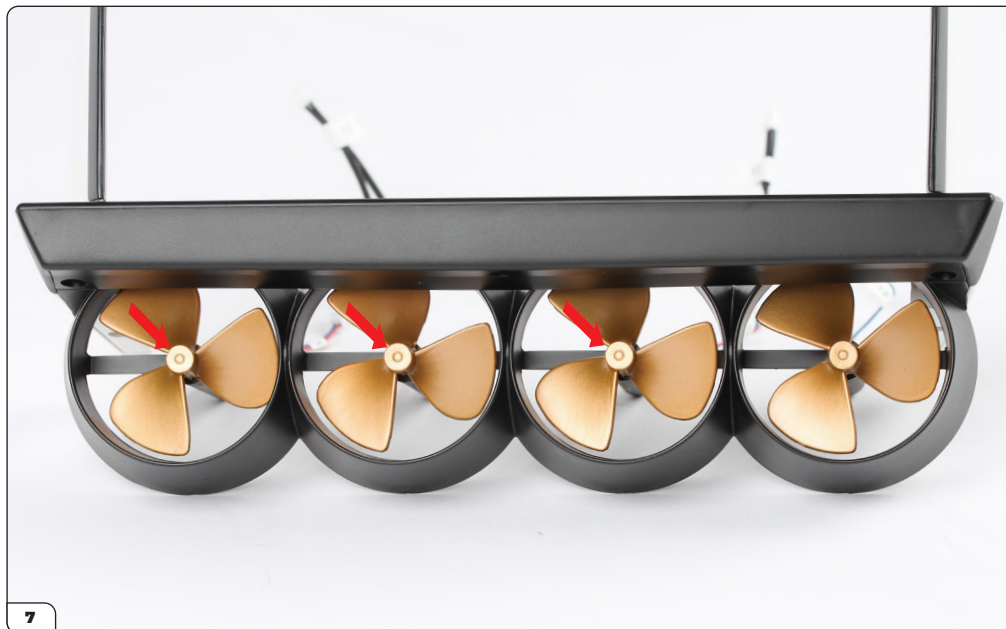

Continue to press all the propellers onto the motors.

Stage 086: Attaching the Propellers

STAGE COMPLETE



Stage 087: Building the Rear Number Plate

In this stage you'll build and attach the rear number plate, which features a hidden jet sprayer compartment.

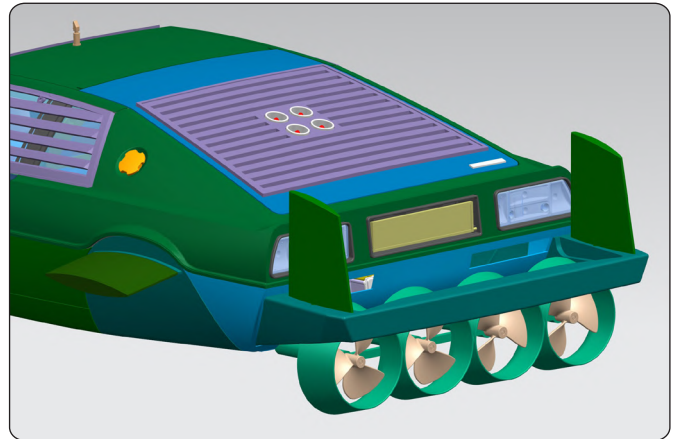

STAGE 087 PARTS LIST

Name	Name
87-A Compartment	87-F Clamp x2
87-B Number plate	87-G Spring x2
87-C Jet sprayers	87-H Number plate sticker
87-D Pipes	PS05 screws x5
87-E Support	



Stage 087: Building the Rear Number Plate



Peel the number plate sticker (87-H) from the backing paper.



Align the sticker with the number plate (87-B) as shown.



Press the sticker into place.

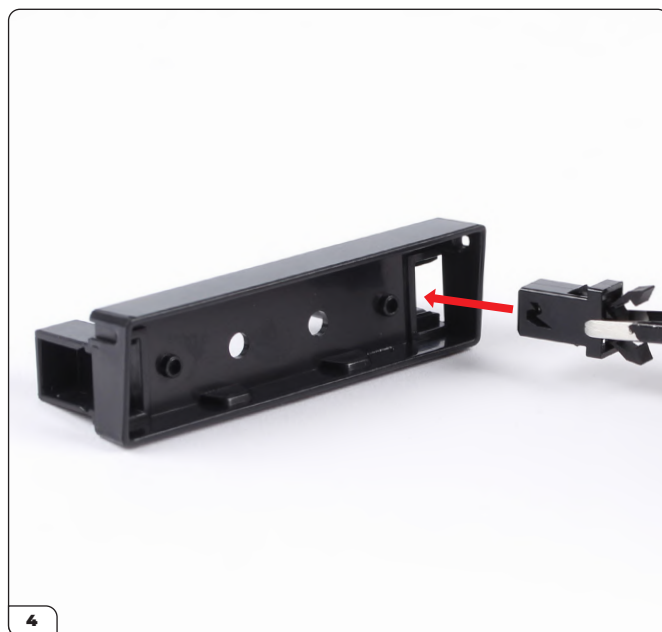

Press a clamp (87-F) into the compartment (87-A).

Stage 087: Building the Rear Number Plate

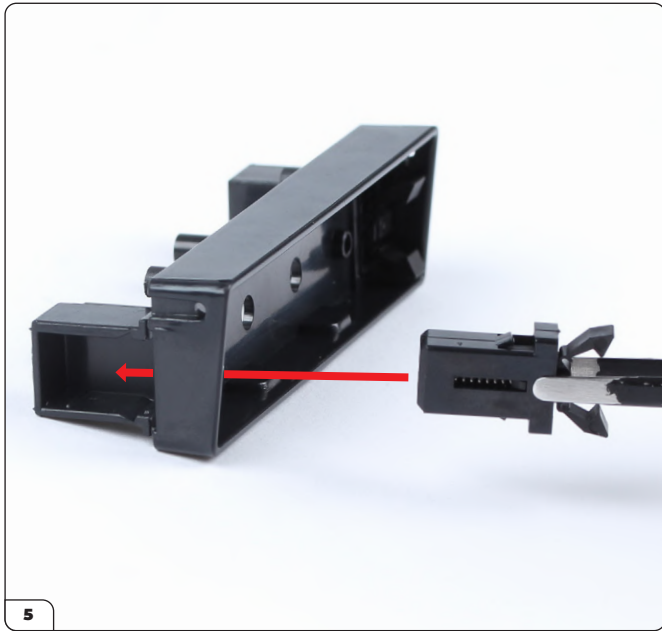

Press the second clamp into the other side.



The assembly should now look like this.

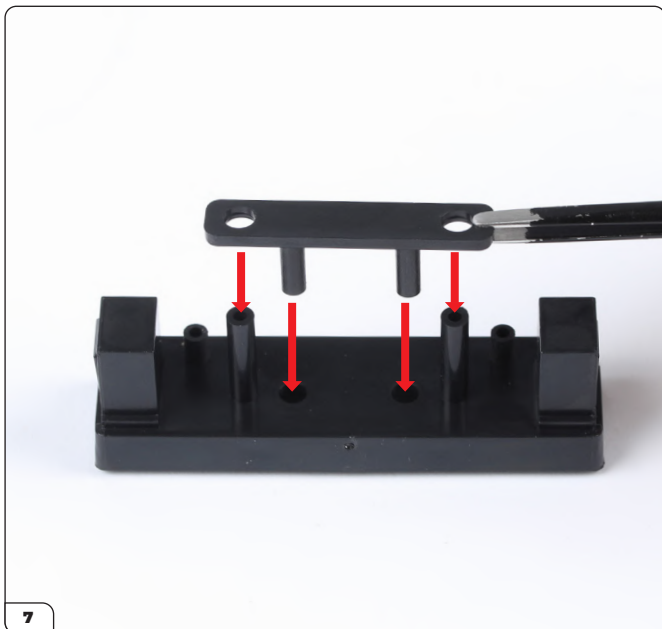

Place the jet sprayers (87-C) onto the assembly.



The assembly should now look like this.

Stage 087: Building the Rear Number Plate

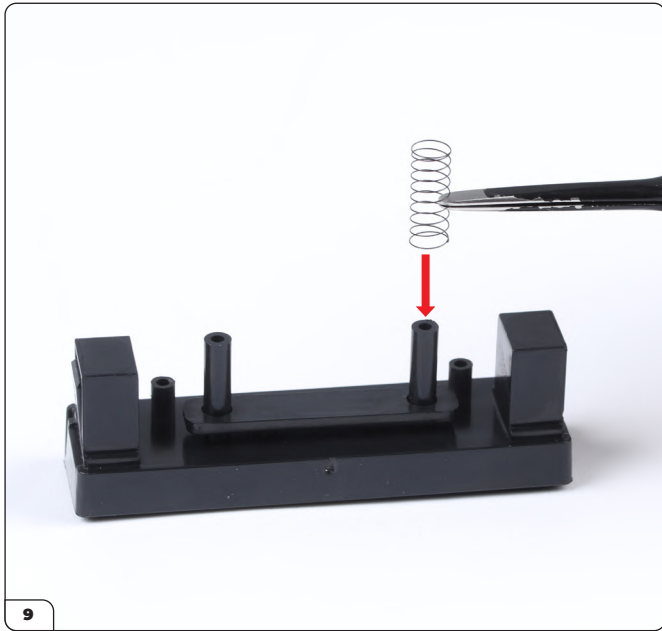

Place a spring (87-G) over a column.

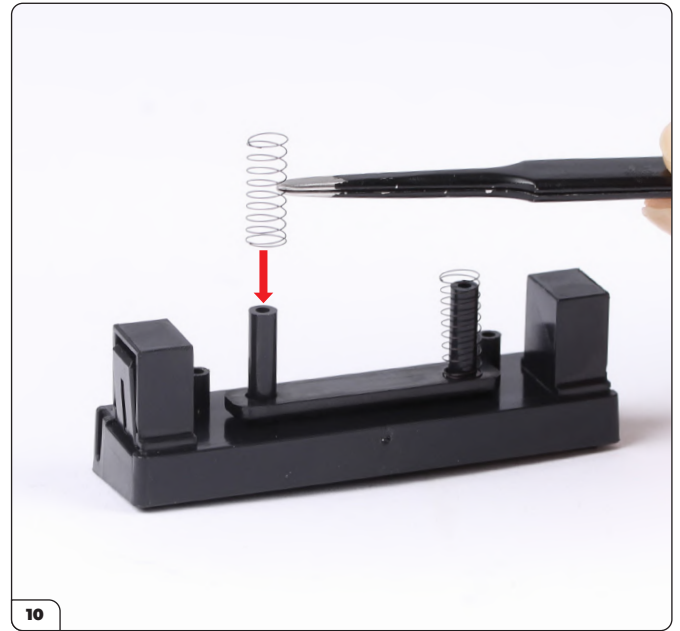

Place the second spring over the other column.

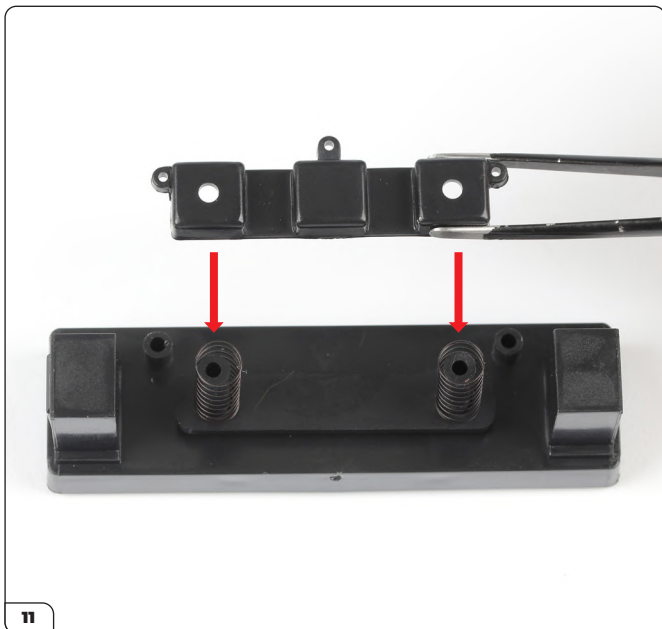

Place the support (87-E) on top of the columns.

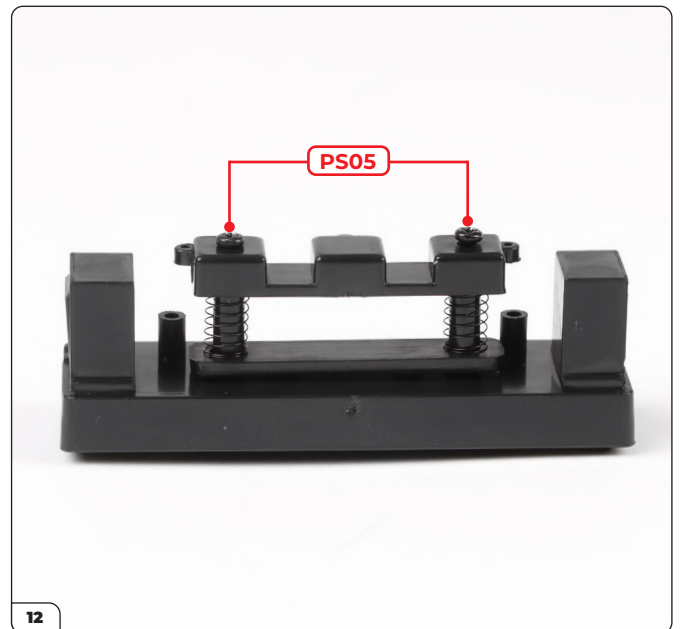

Secure in place with 2x PS05 screws.

Stage 087: Building the Rear Number Plate



Fit the number plate to the assembly, fixing the pin to the bracket on one side.

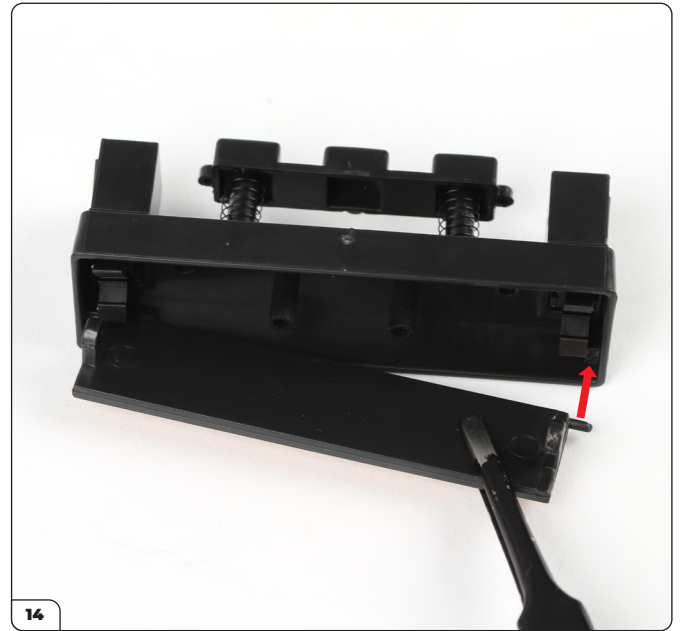

Then fix the pin to the bracket on the opposite end. You will need to flex the number plate slightly to get the second pin in its hole.



Press the number plate into the clamps to close it. Press the number plate again to open and reveal the jet sprayer compartment.

Stage 087: Building the Rear Number Plate



Align the assembly with the main body (stage 082).



Push into place.

Stage 087: Building the Rear Number Plate

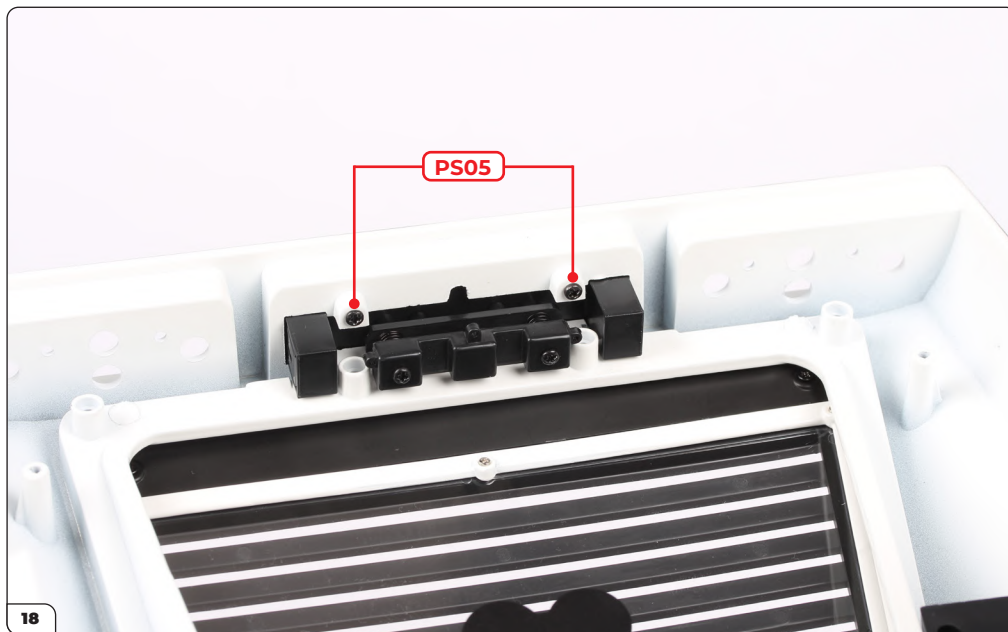

Carefully turn the assembly over and secure the number plate in place with 2x PS05 screws.

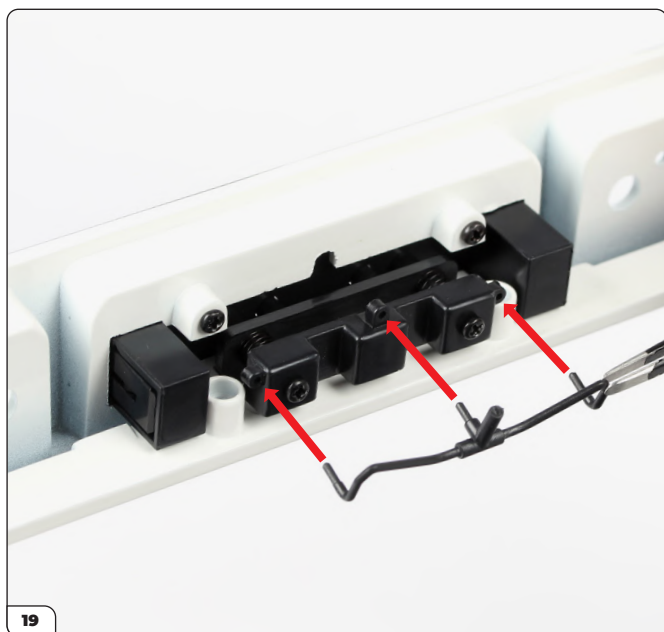

Press the pipes (87-D) into the support.



The pipes should look like this once in place.

Stage 087: Building the Rear Number Plate

STAGE COMPLETE



Stage 088: Fitting the Rear Right Lights

In this stage you'll build and then fit the rear right lights.

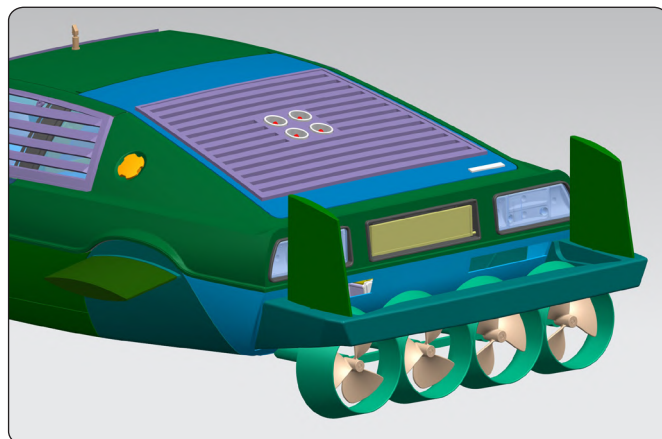

STAGE 088 PARTS LIST

Name
88-A Reflector
88-B LED circuit board
88-C Rear light housing
88-D Rear light glass
PS05 screws x3

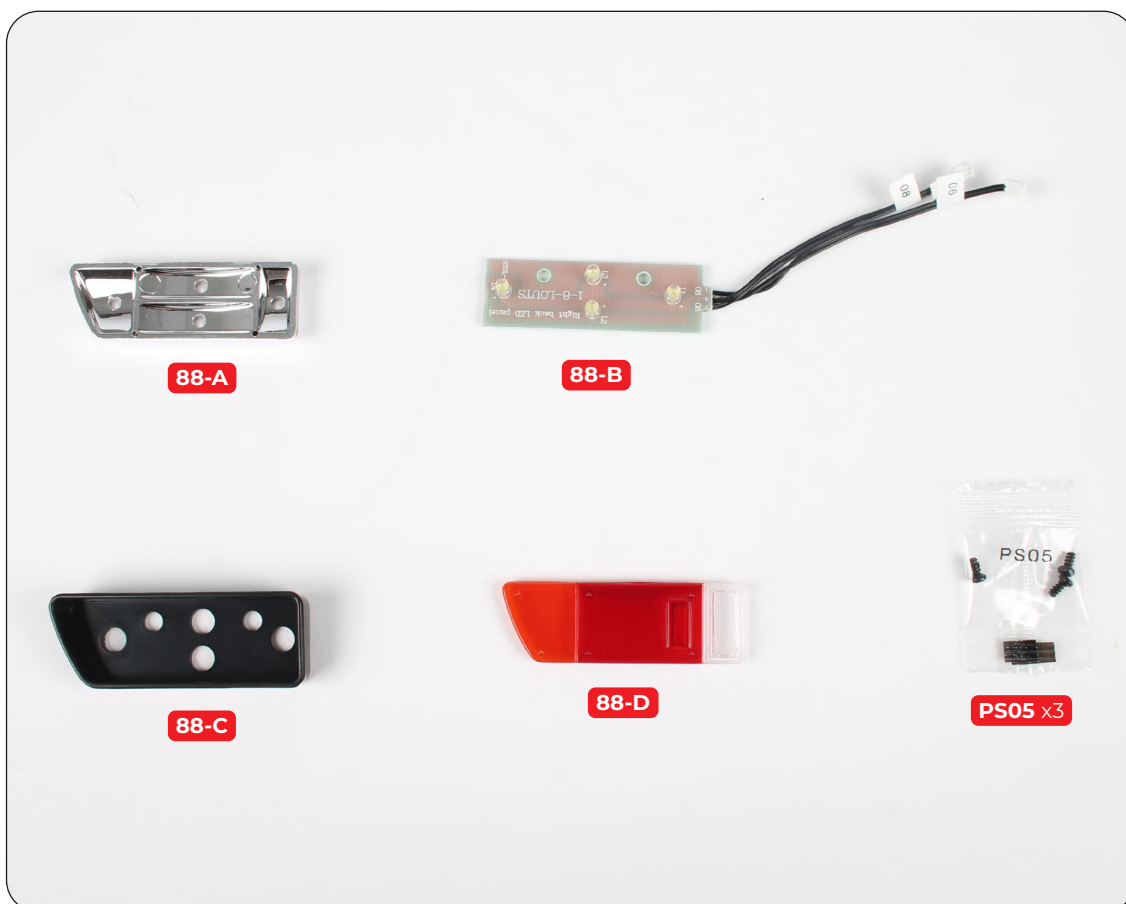

Stage 088: Fitting the Rear Right Lights



Place the rear light housing (88-C) into the main body (stage 087).



Press the rear light glass (88-D) into the reflector (88-A).



Press the assembly into the rear light housing.

Stage 088: Fitting the Rear Right Lights



The rear light should now look like this.



Carefully turn the assembly over. Align the LED circuit board (88-B) as shown.

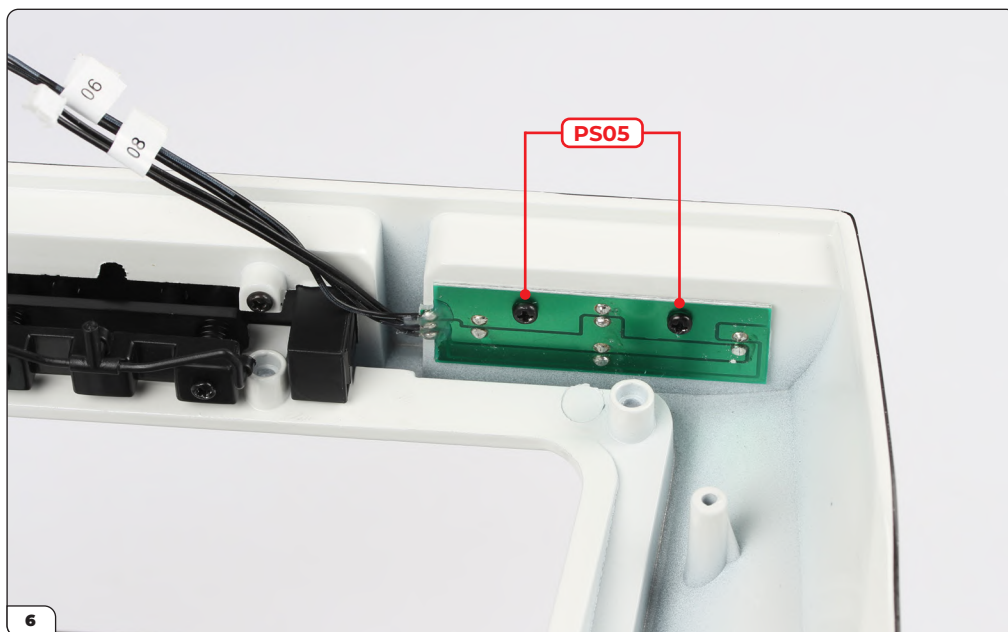

Place the circuit board then secure with 2x PS05 screws.

Stage 088: Fitting the Rear Right Lights

STAGE COMPLETE



Stage 089: Fitting the Rear Left Lights

Now you'll build and then fit the rear left lights.

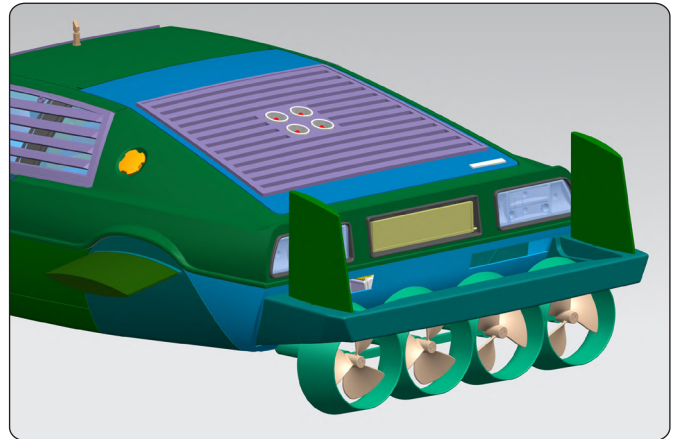

STAGE 089 PARTS LIST

Name
89-A Reflector
89-B LED circuit board
89-C Rear light housing
89-D Rear light glass
PS05 screws x3

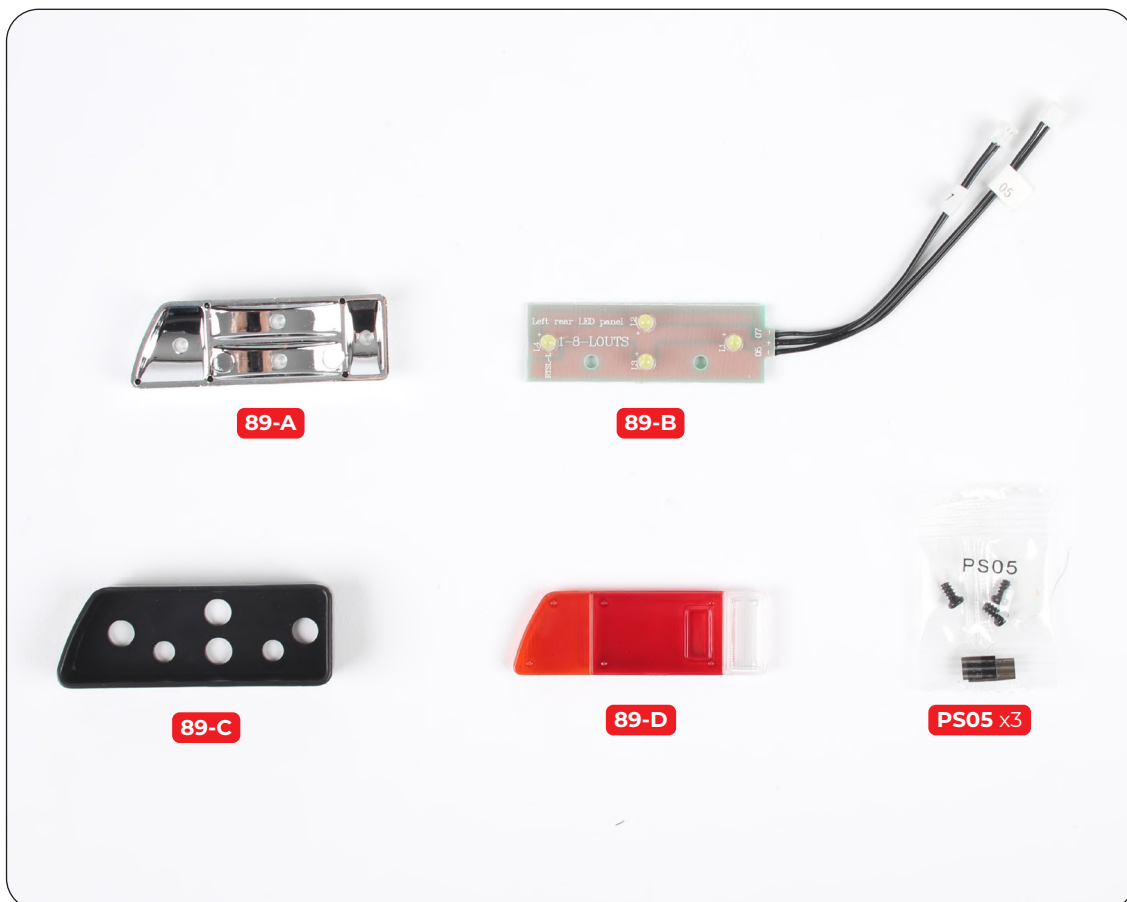

Stage 089: Fitting the Rear Left Lights



Place the rear light housing (89-C) into the main body (stage 088).



Press the rear light glass (89-D) into the reflector (89-A).

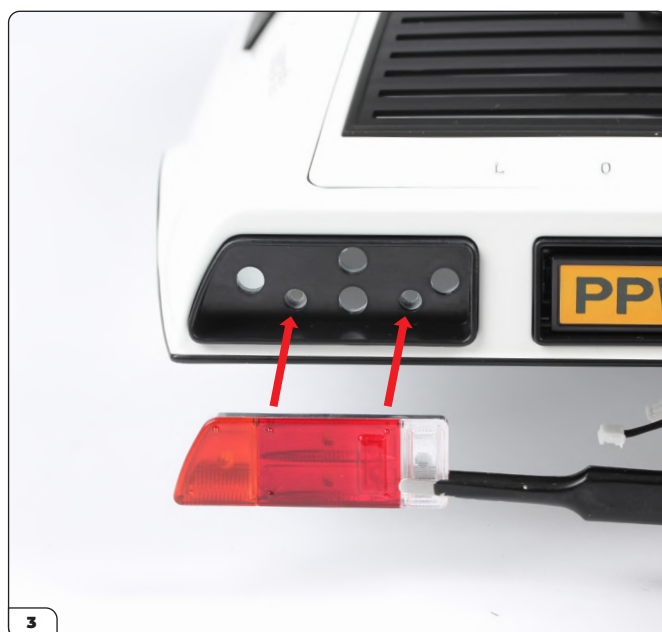

Press the assembly into the rear light housing.

Stage 089: Fitting the Rear Left Lights



The rear light should now look like this.

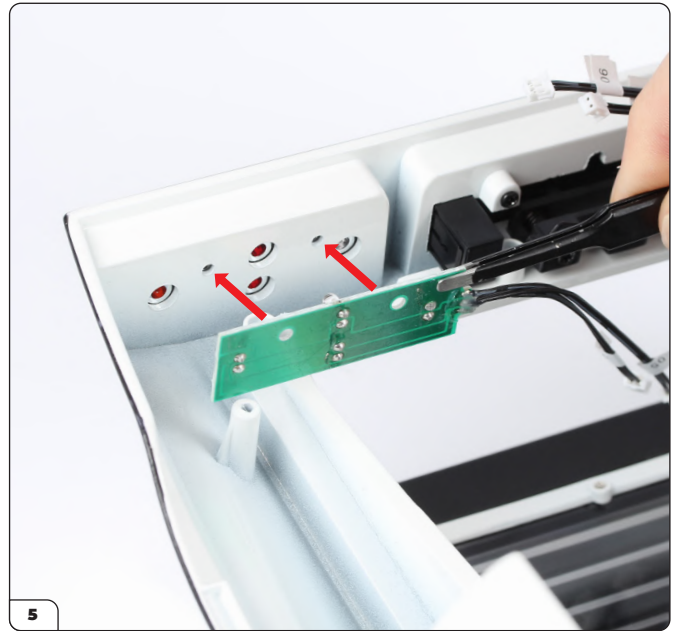

Carefully turn the assembly over. Align the LED circuit board (89-B) as shown.

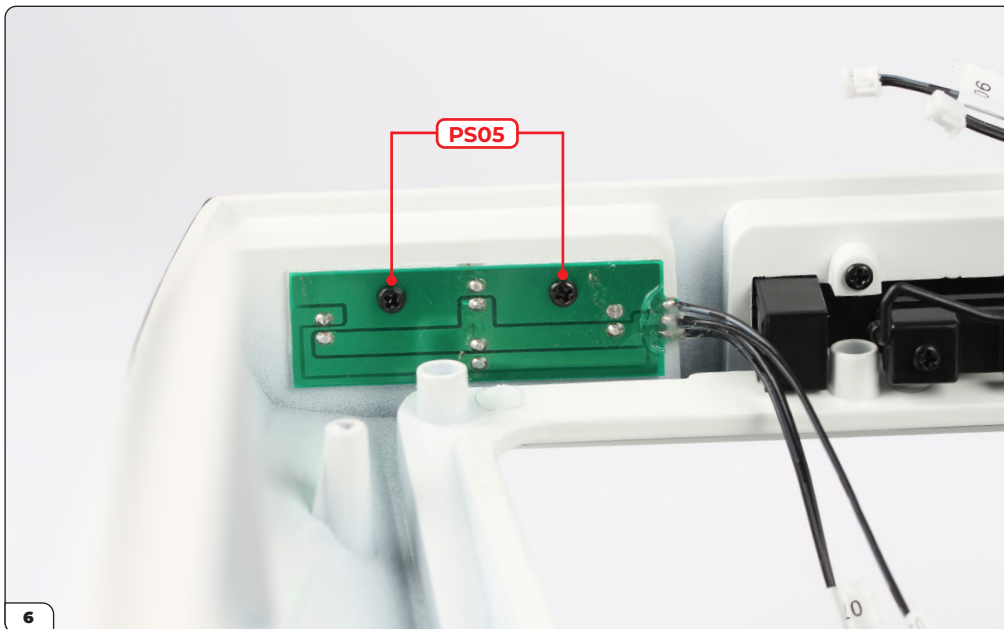

Place the circuit board then secure with 2x PS05 screws.

Stage 089: Fitting the Rear Left Lights

STAGE COMPLETE



Stage 090: Installing the Cockpit and Chassis

In this stage you'll install the cockpit and the chassis onto the main body. You'll also fit the rear fuel tanks and make a correction to the chassis wires.

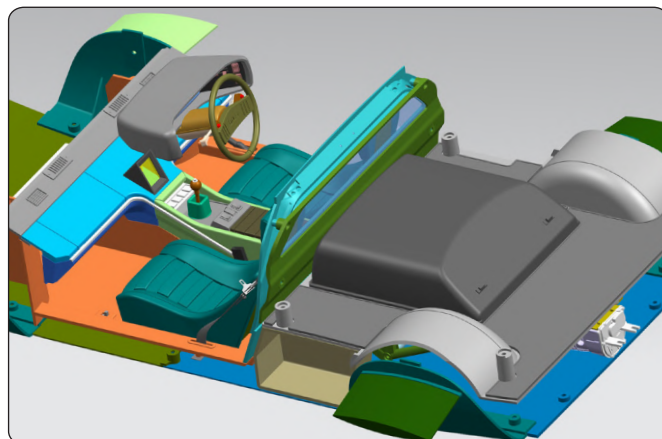

STAGE 090 PARTS LIST

Name
90-A Fuel tank (L)
90-B Fuel tank (R)
DS02 screws x7
PS05 screws x7



90-A



90-B



DS02 x7



PS05 x7

Stage 090: Installing the Cockpit and Chassis

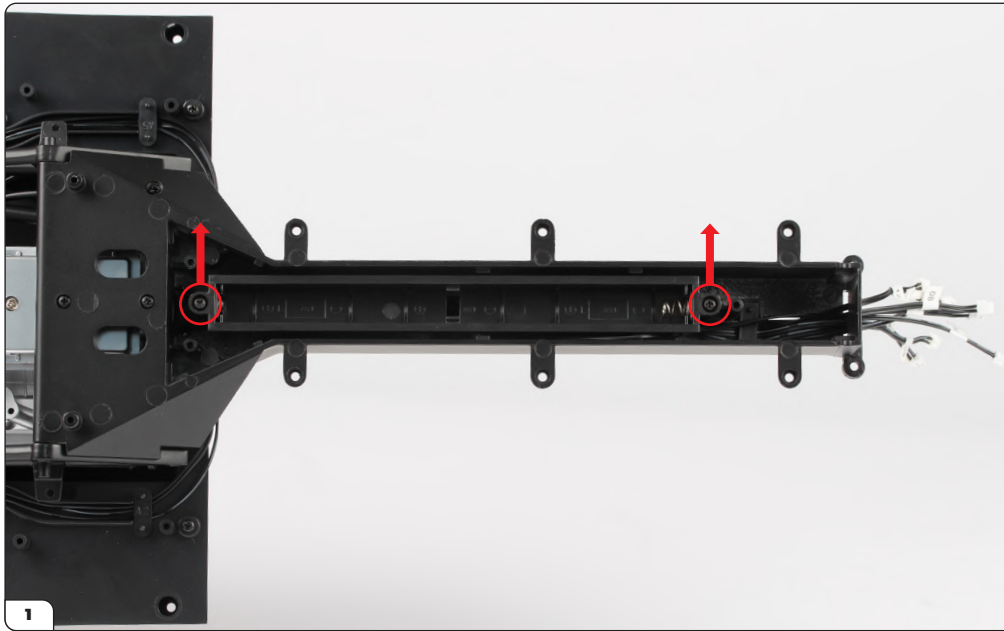

Take the chassis (stage 044) and remove the DS02 screws securing the battery compartment.

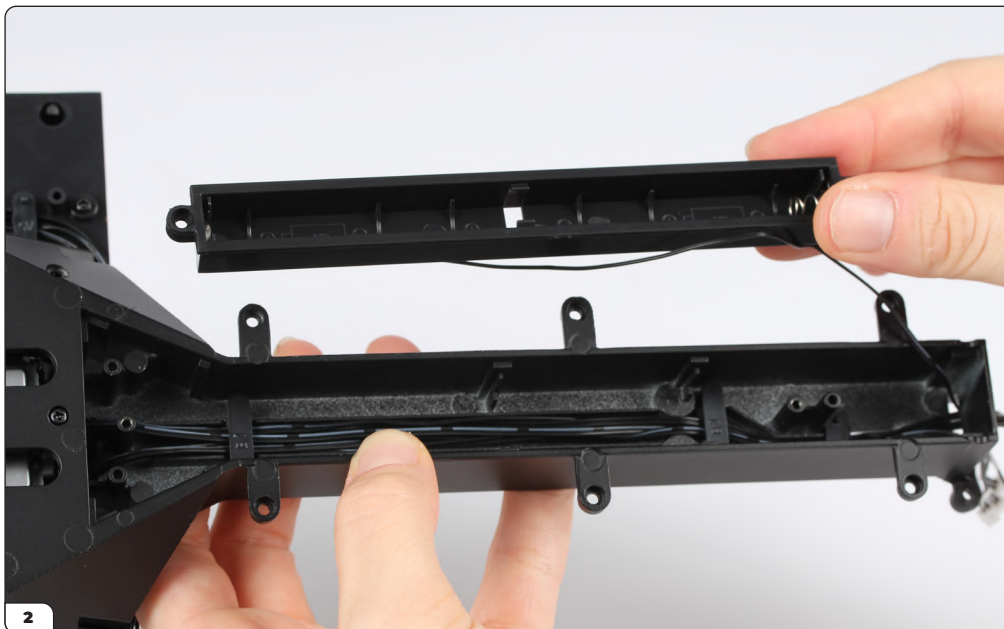

Lift out the battery compartment. Take care not to damage the wire connected to the battery compartment.

Stage 090: Installing the Cockpit and Chassis

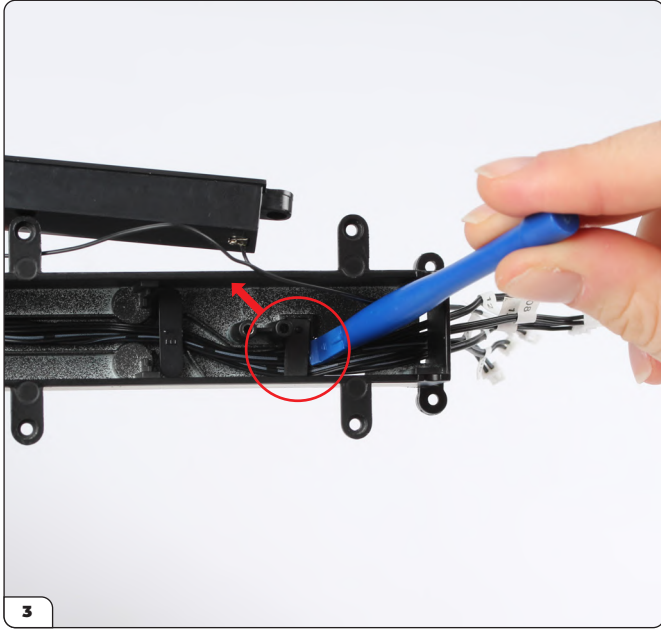

Remove the small wire bracket. This can be discarded.

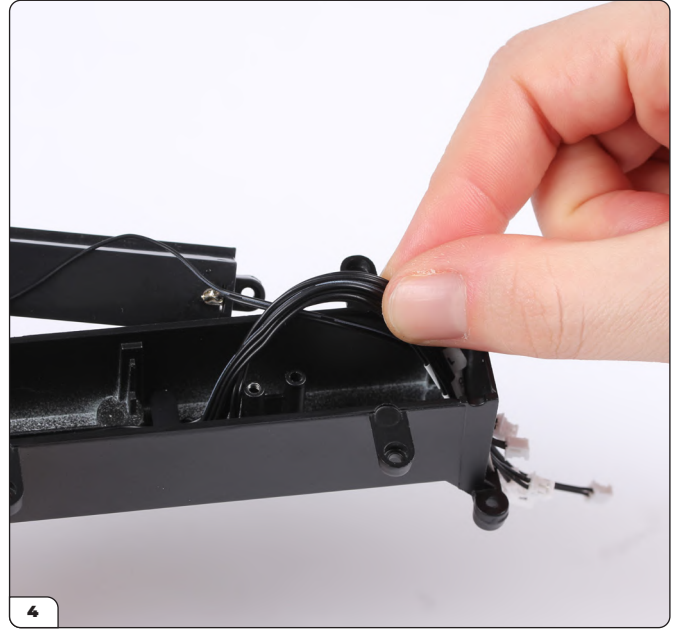

Carefully pull the wires until you have some slack.

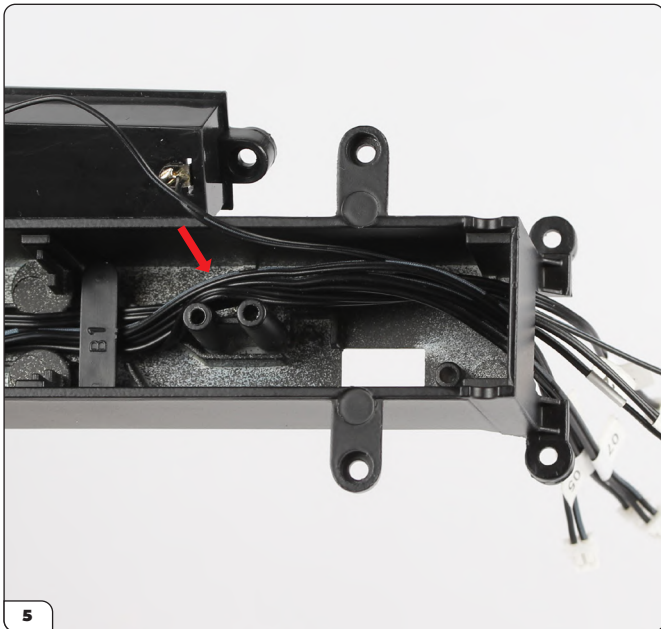

Move the wires to the other side of the screw columns as shown.

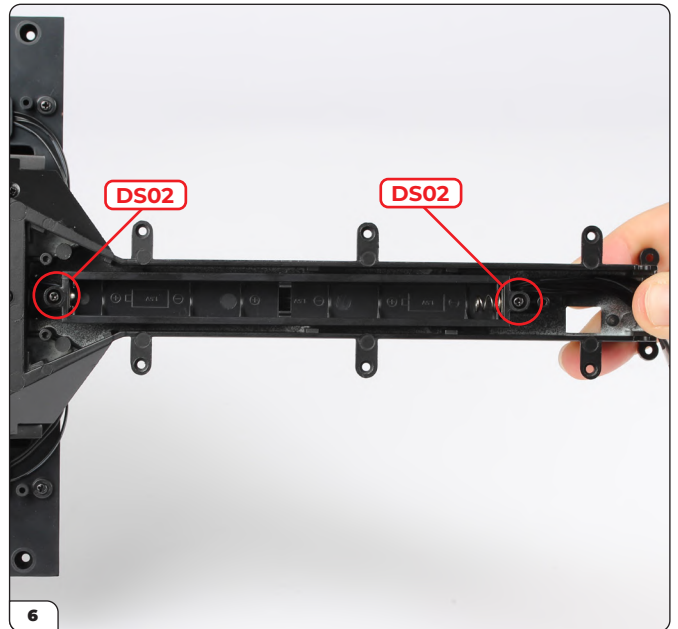

Replace the battery compartment and secure using the DS02 screws removed in step 1.

Stage 090: Installing the Cockpit and Chassis



Take the main body (stage 089) and place it upside down, supported by a protected surface.

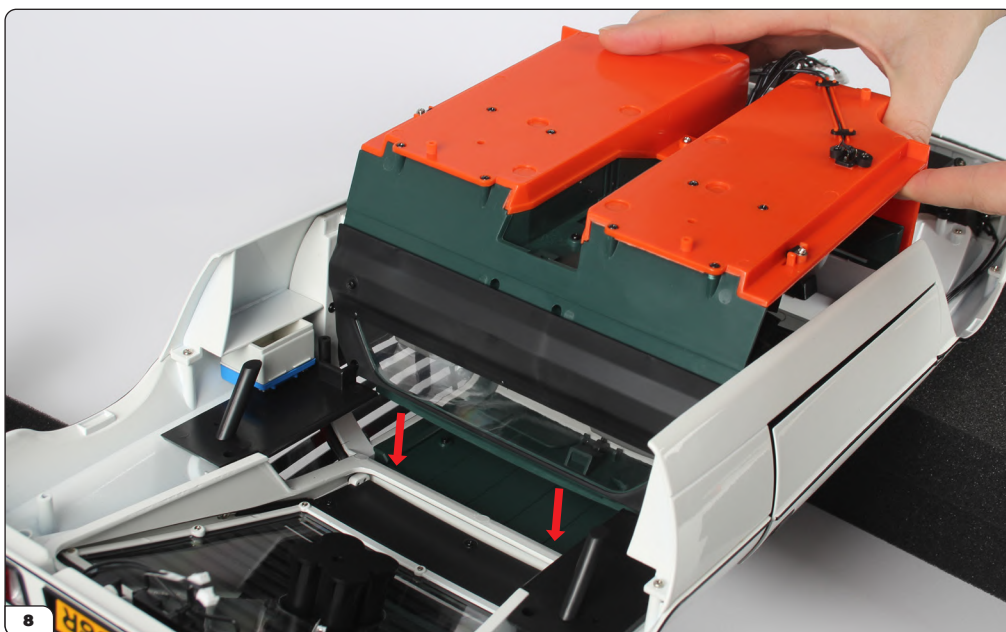

Start to fit the cockpit (stage 050) by pushing the bulkhead into place.

Stage 090: Installing the Cockpit and Chassis

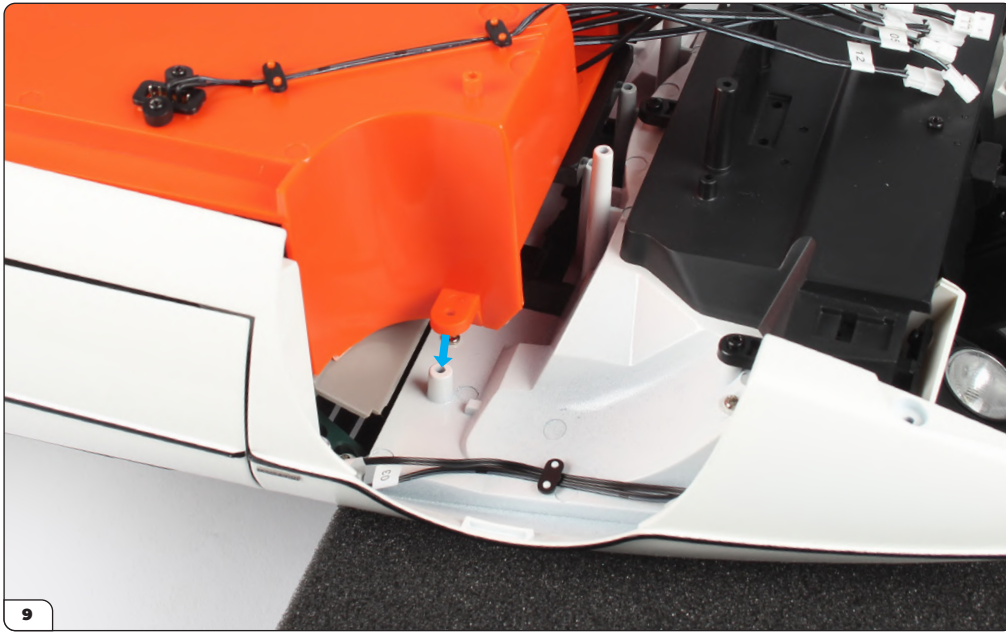

At the front, push the tabs onto the columns.

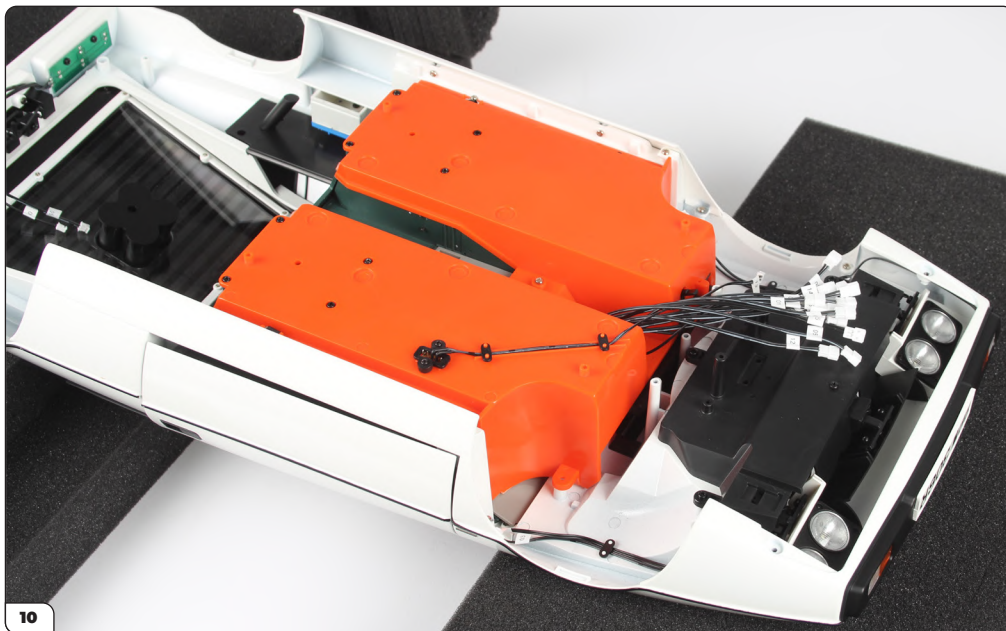

The cockpit should look like this once in place.

Stage 090: Installing the Cockpit and Chassis

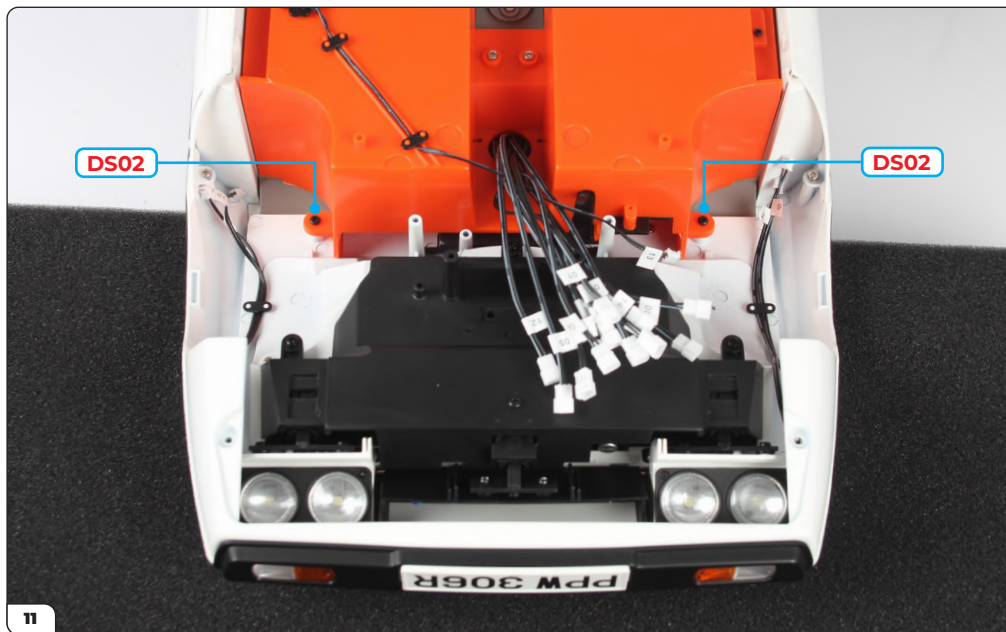

Secure the front with 2x DS02 screws.

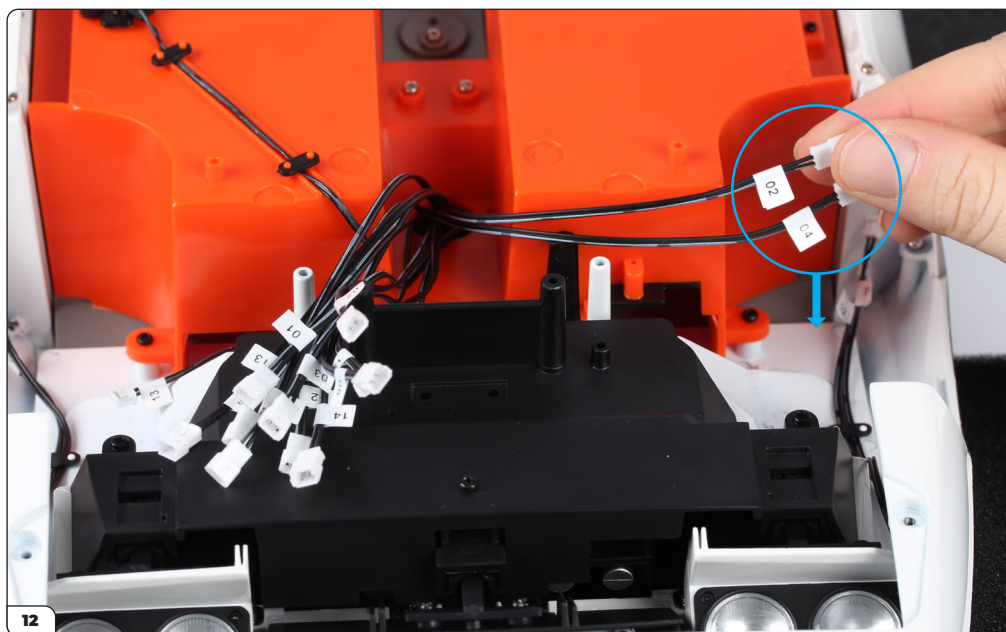

Move the wires No. 02 and 04 towards the front right wheel arch.

Stage 090: Installing the Cockpit and Chassis

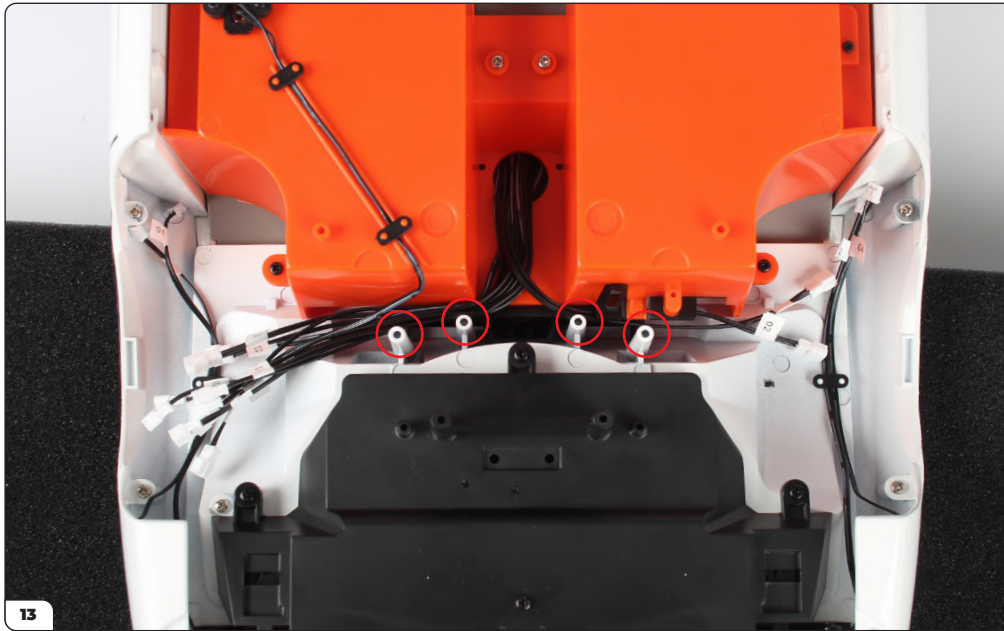

Move all the other wires towards the front left wheel arch as shown. **Make sure the wires are not covering the four screw columns (circled).**

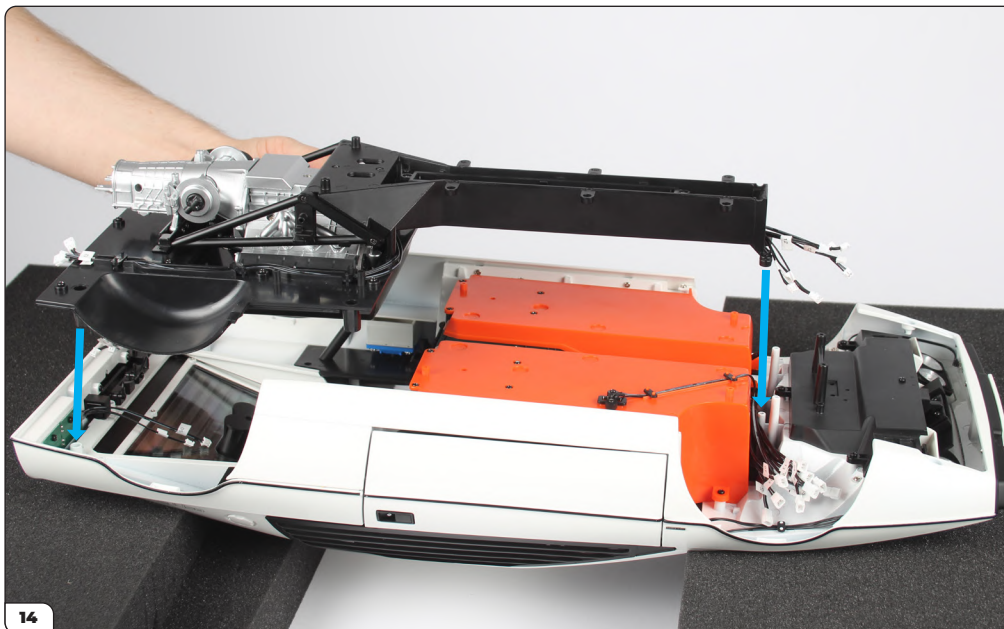

Place the chassis onto the assembly.

Stage 090: Installing the Cockpit and Chassis

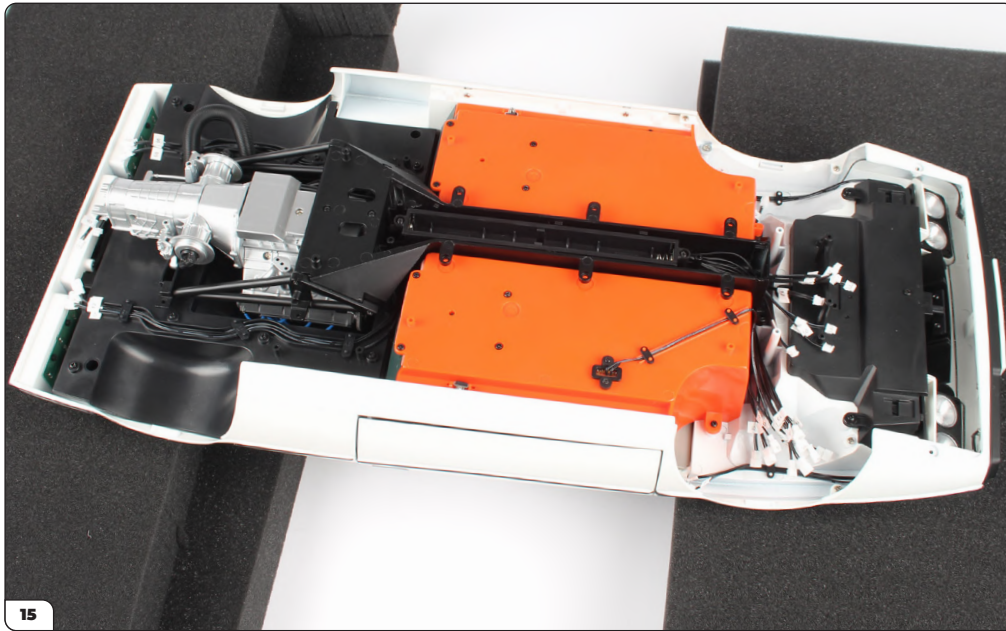

The chassis should look like this once in place.

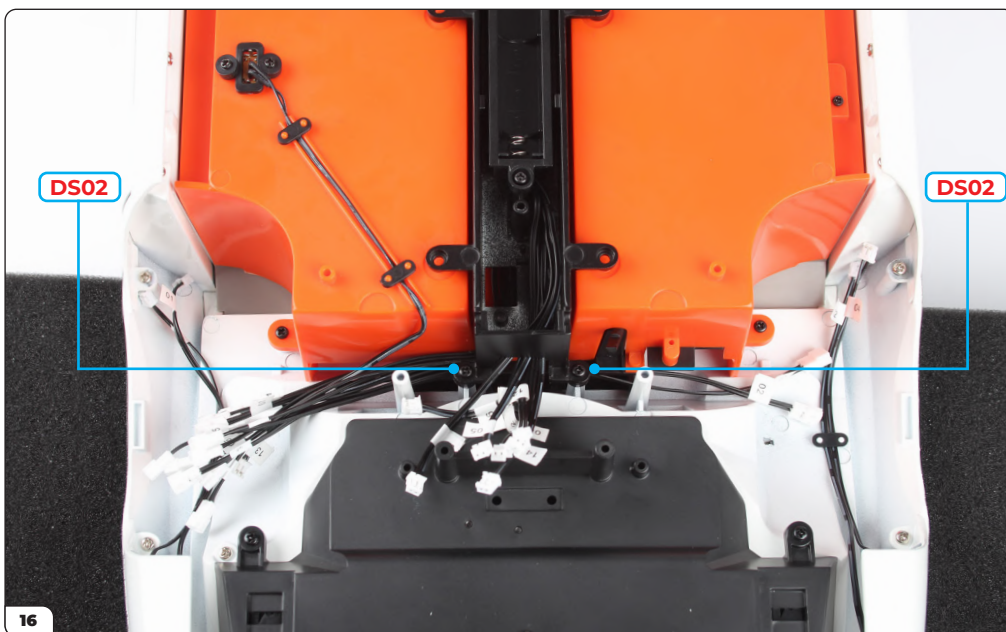

Secure the front with 2x DS02 screws.

Stage 090: Installing the Cockpit and Chassis

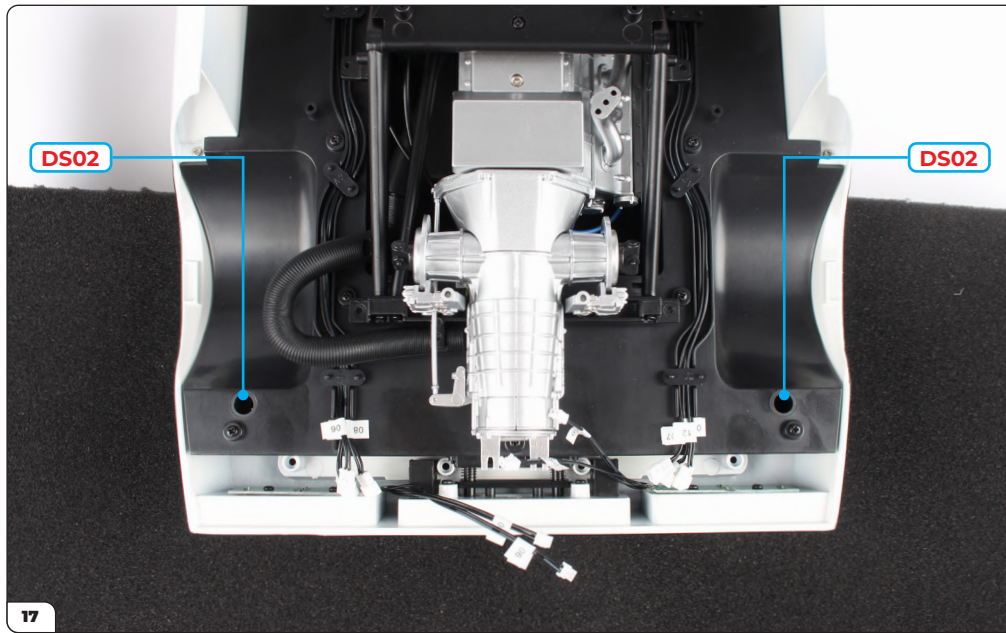

Secure the back with 2x DS02 screws.

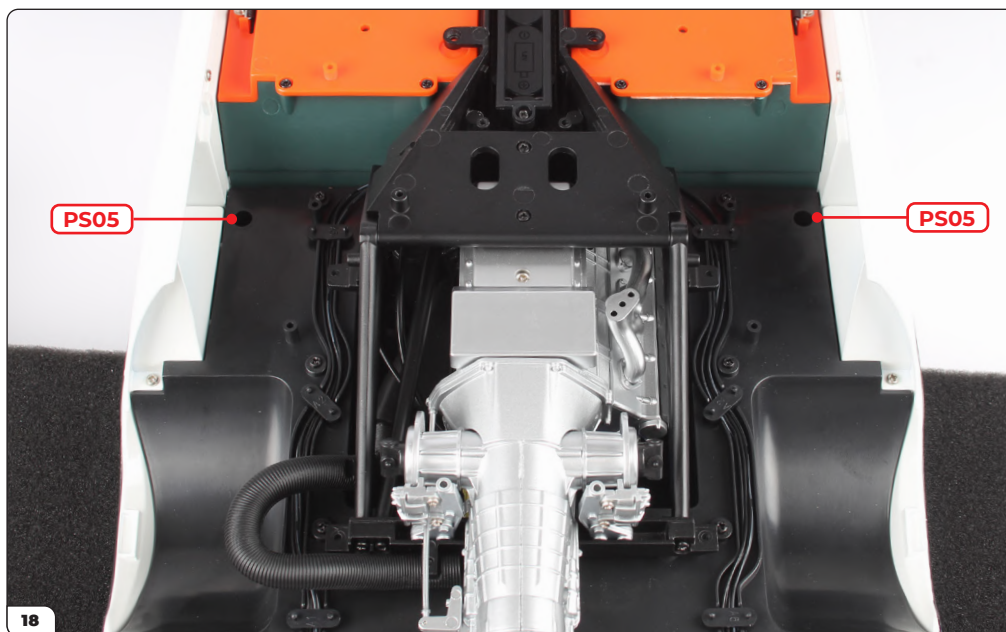

Secure the middle with 2x PS05 screws.

Stage 090: Installing the Cockpit and Chassis



The right (90-B) and left (90-A) fuel tanks are marked with 'R' and 'L' (circled).

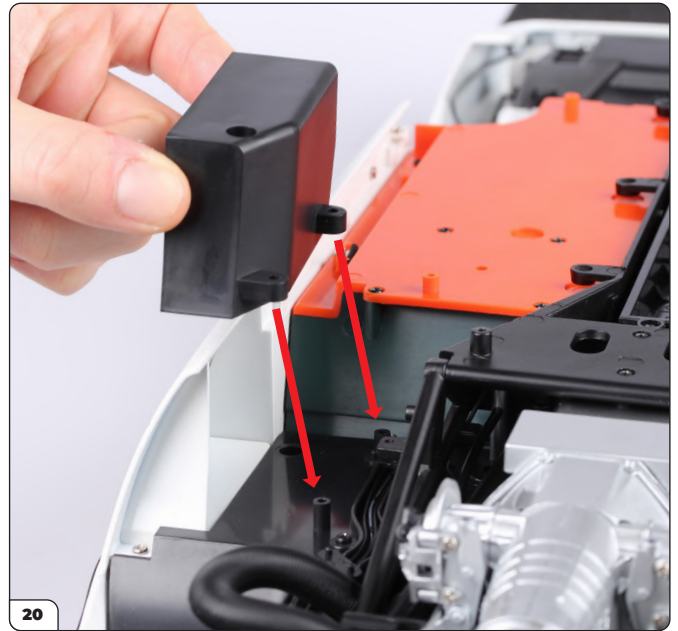

Place the right fuel tank onto the assembly.

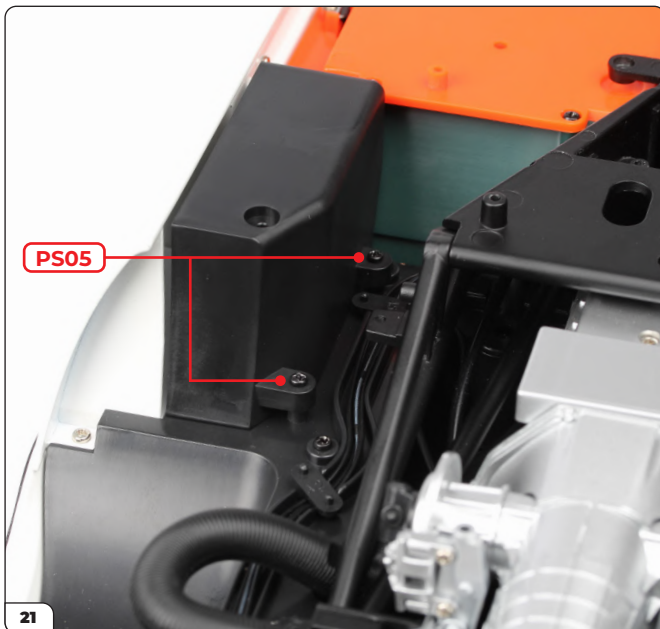

Secure with 2x PS05 screws.

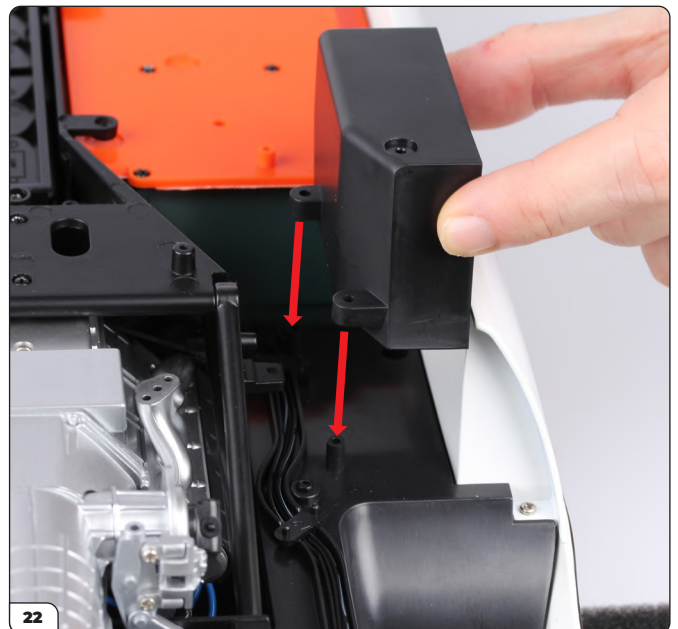

Place the left fuel tank onto the assembly.

Stage 090: Installing the Cockpit and Chassis

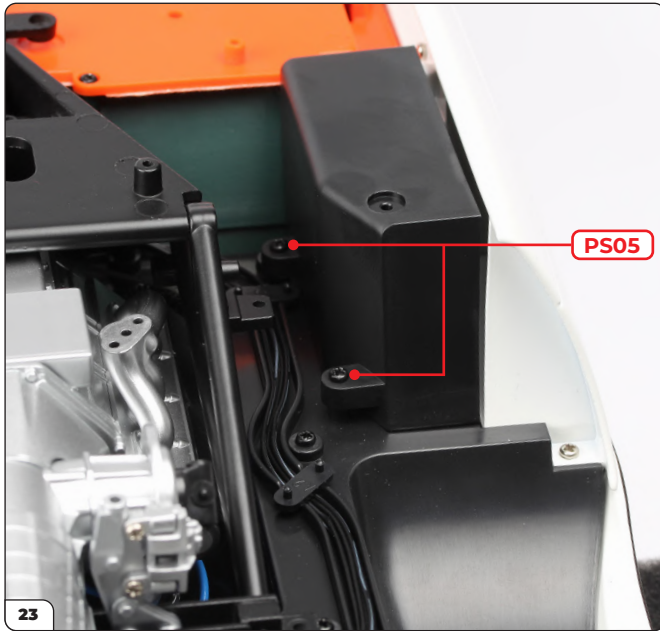

Secure with 2x PS05 screws.

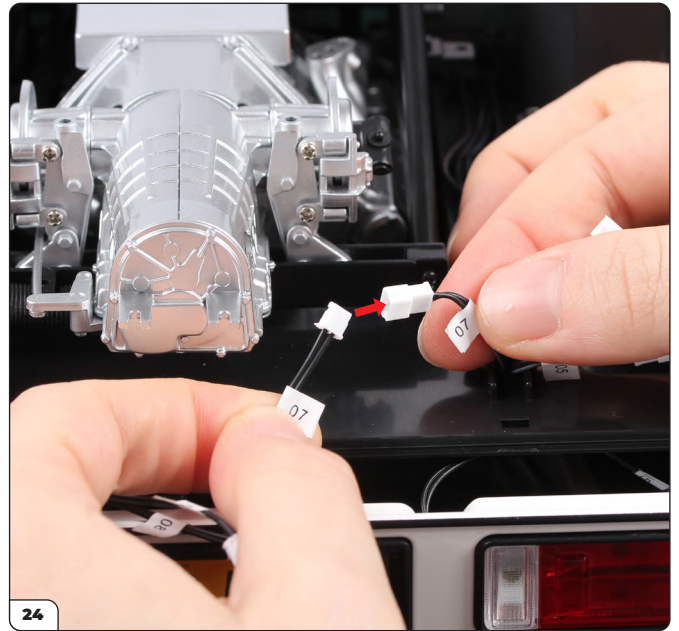

Connect the No. 07 wires at the back of the assembly.



Connect the No. 05, 06 and 08 wires. The No. 12 wires will be connected in a later stage.

Stage 090: Installing the Cockpit and Chassis

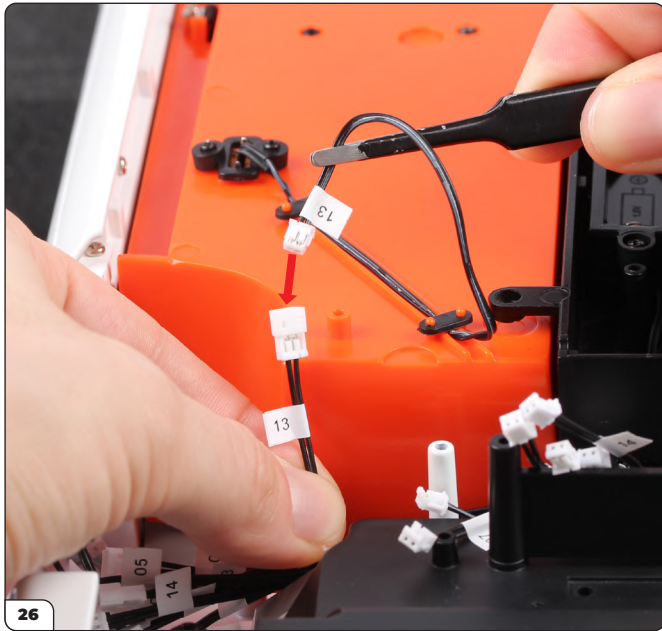

Connect the No. 13 wires in the middle of the assembly.

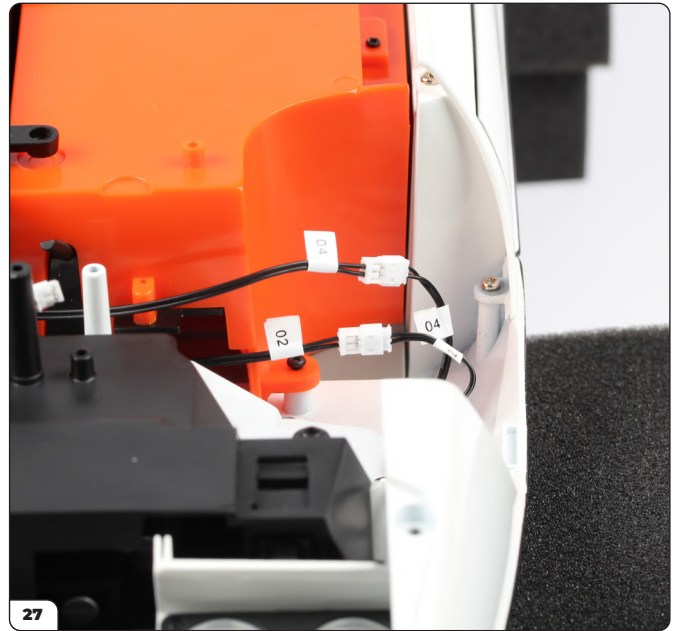

Connect the No. 02 and 04 wires in the front right wheel arch.



Connect the No. 01 and 03 wires in the front left wheel arch.



Connect the No. 05, 06, 07, 08, 12, 13 and 14 wires at the front of the assembly. Double check that all the front wires have been connected.

Stage 090: Installing the Cockpit and Chassis

STAGE COMPLETE



Stage 091: Installing the Rear Valance

In this stage you'll attach the rear bumper and rear valance together then fit them to your model.

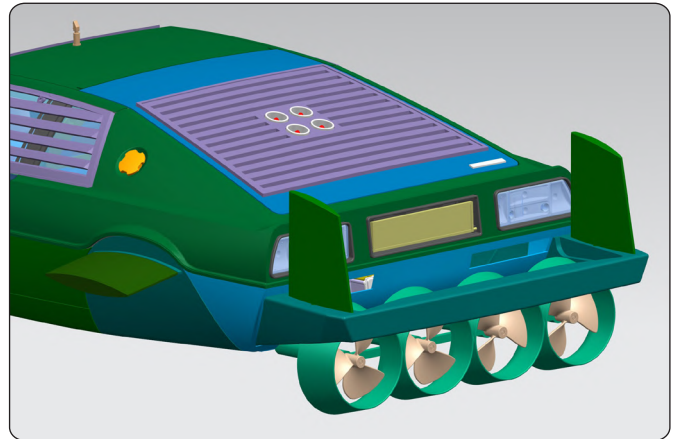

STAGE 091 PARTS LIST

Name
91-A Rear valance
91-B Cover (L)
91-C Cover (R)
91-D Screw cap x6
DS02 screws x7
PS25 screws x5



Stage 091: Installing the Rear Valance

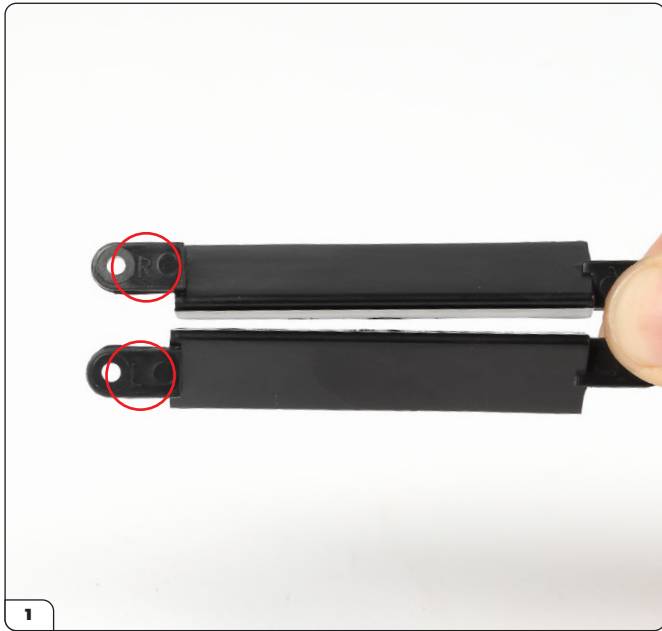

The left (91-B) and right (91-C) covers are marked with 'L' and 'R' (circled).

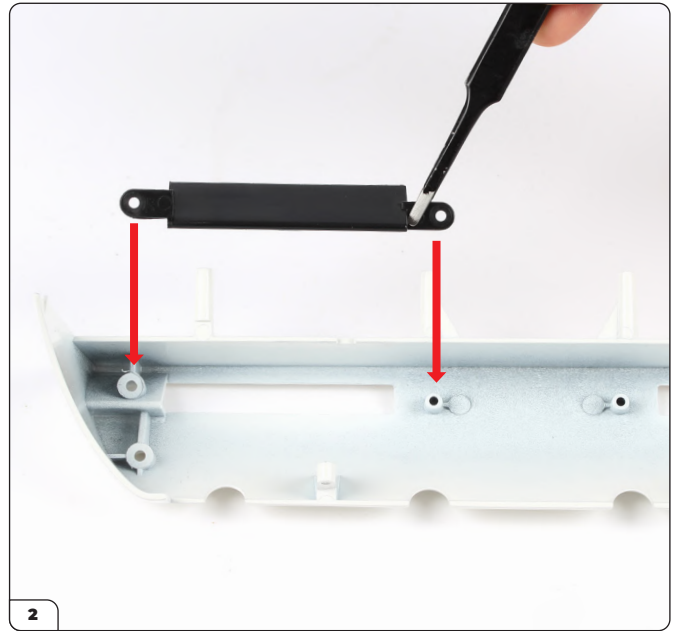

Place the right cover onto the rear valance (91-A).

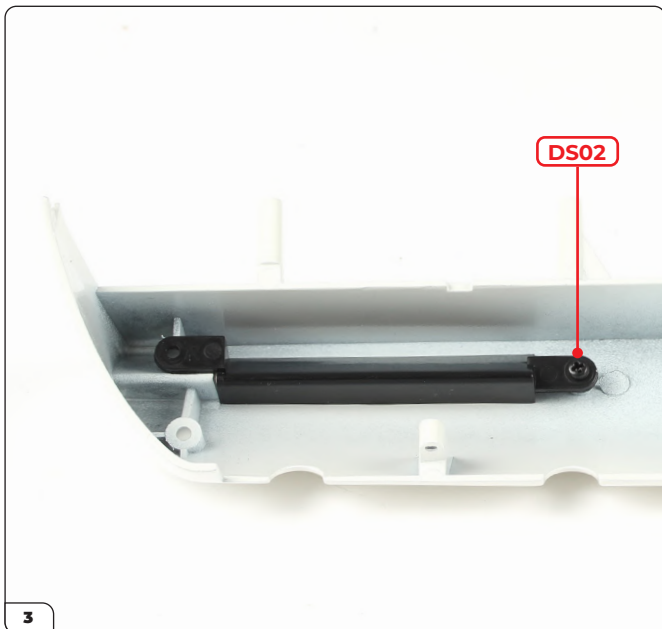

Use a DS02 screw to hold in place.

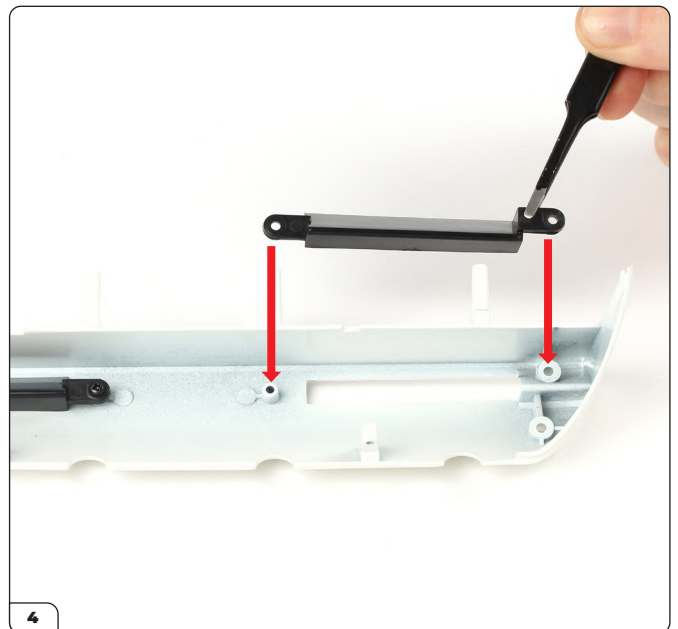

Place the left cover onto the rear valance.

Stage 091: Installing the Rear Valance

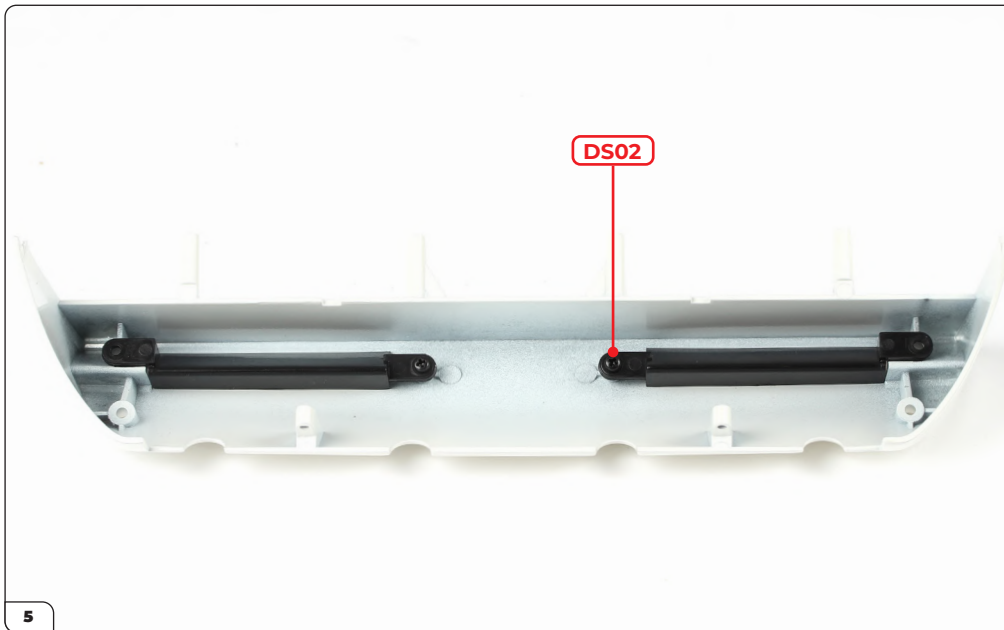

Use a DS02 screw to hold in place.



Align the rear valance with the propeller assembly (stage 086).

Stage 091: Installing the Rear Valance

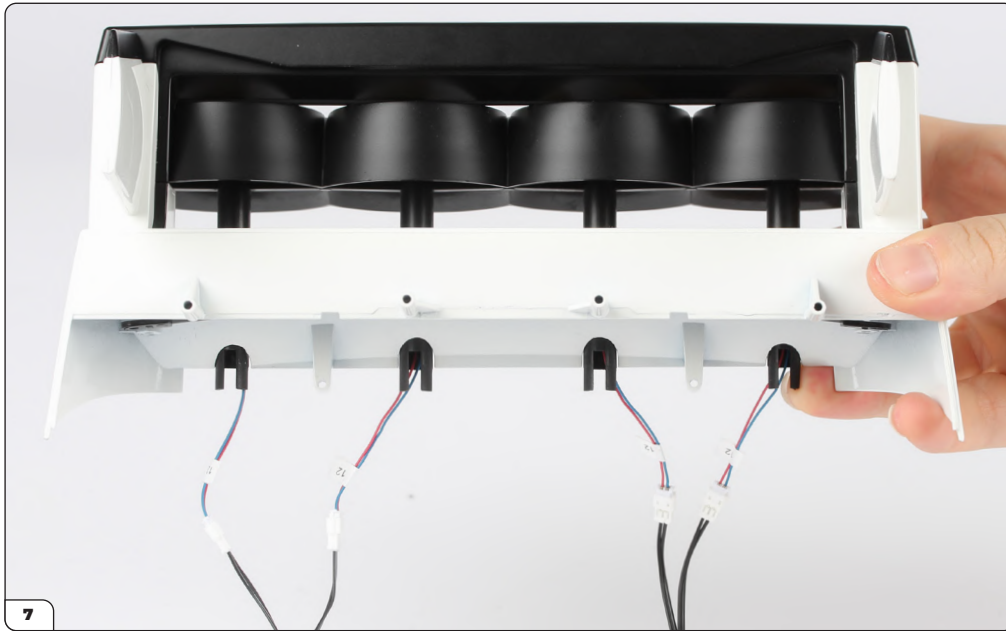

Press the assemblies together.

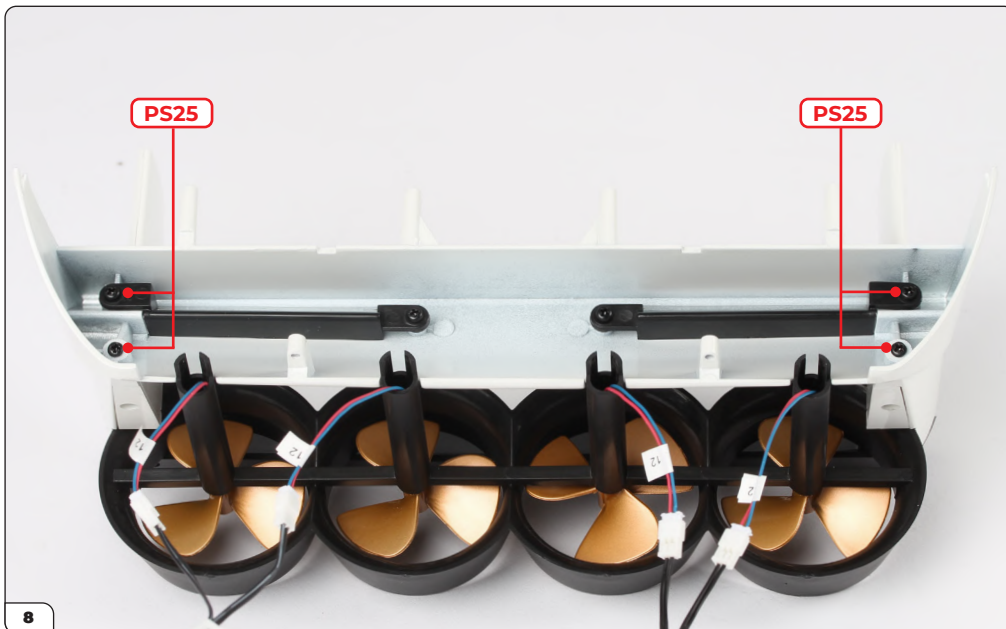

Use 4x PS25 screws to secure.

Stage 091: Installing the Rear Valance



Place the main assembly on your work surface using a protective support as shown. Open the tailgate.

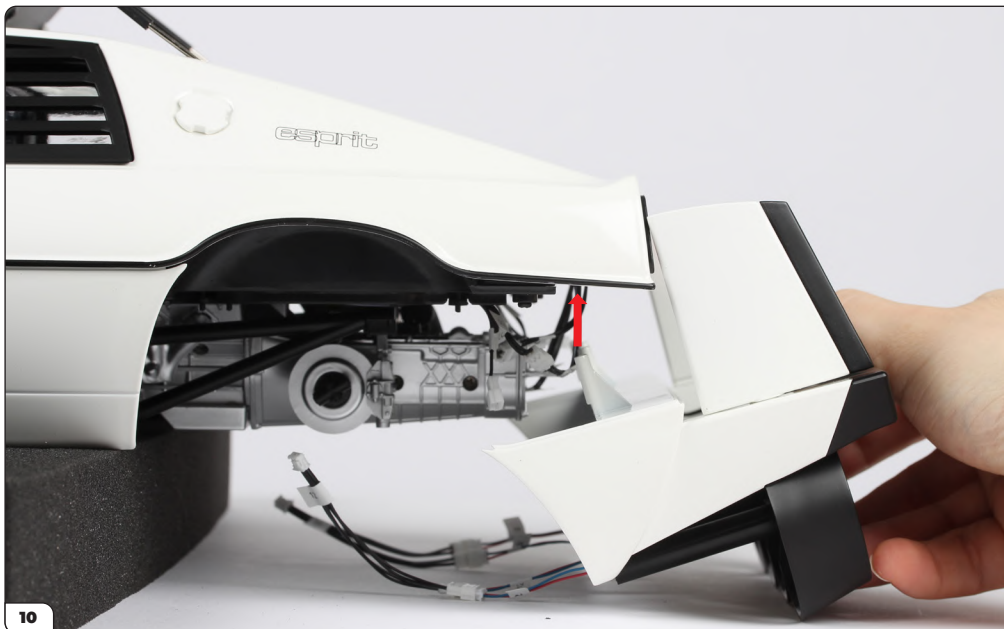

Hold the rear valance under the assembly.

Stage 091: Installing the Rear Valance



Fit the rear valance into position. Make sure the screw posts are aligned with the holes in the main body (circled) and that none of the wires become trapped.

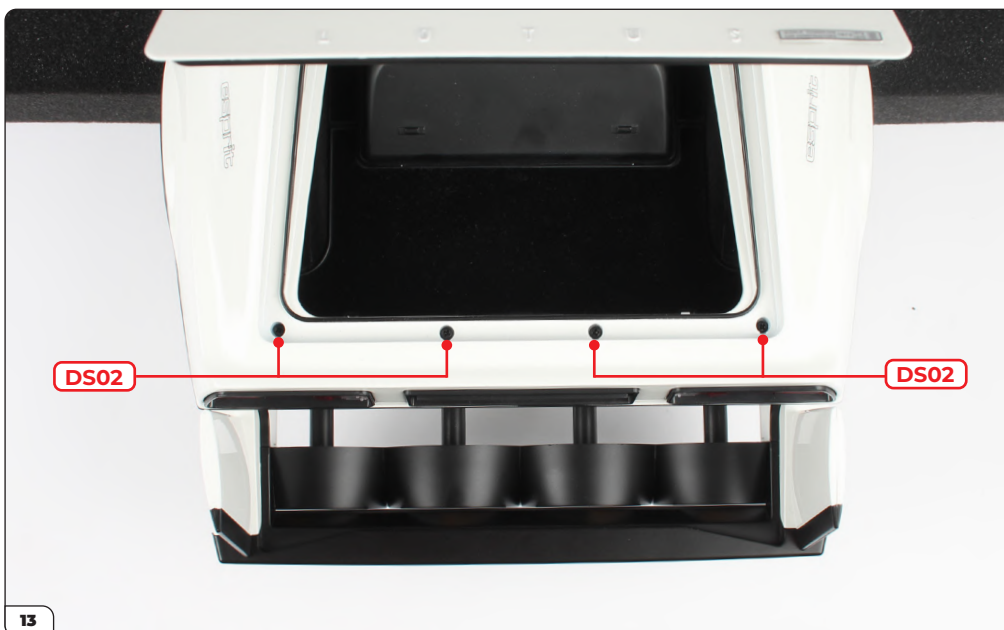

Secure with 4x DS02 screws.

Stage 091: Installing the Rear Valance

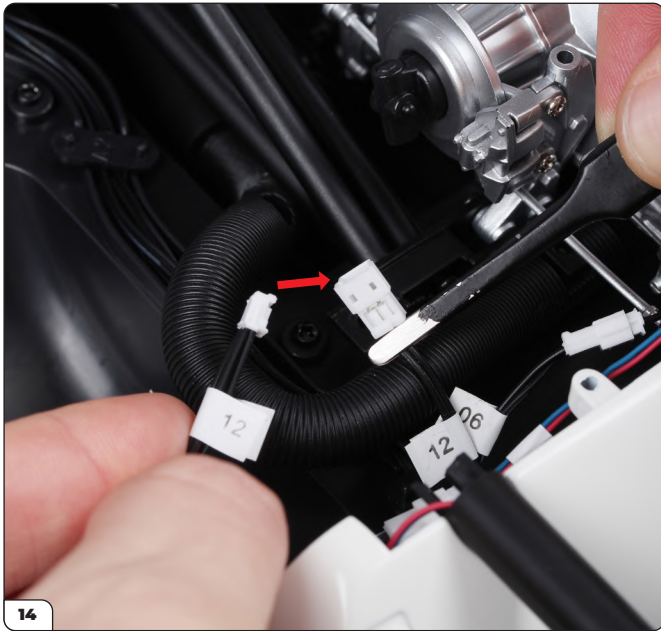

Carefully turn the assembly over and start to plug the No. 12 wires together.

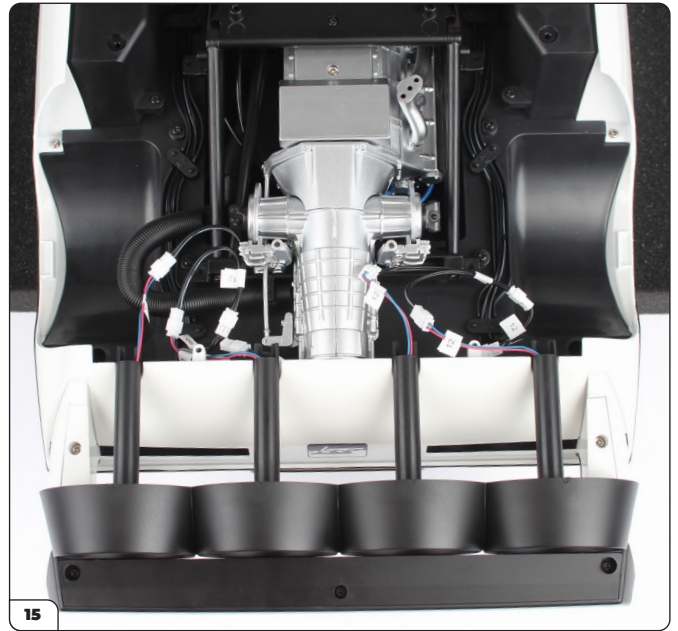

Repeat for all No. 12 wires. All the wires at the back of the model should now be connected.

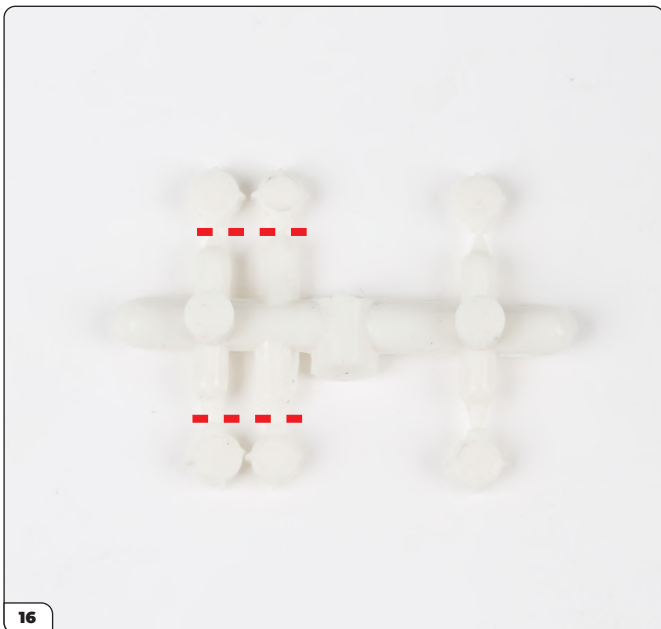

Cut four screw caps (91-D) from the sprue.

Note: you may prefer to add these screw caps after testing the electrics in the next pack.



Press a cap over the top of the screws.

Stage 09I: Installing the Rear Valance



Press a cap over each screw.



When storing your model, keep the underside supported to prevent any damage to the propeller guard.

Stage 091: Installing the Rear Valance

STAGE COMPLETE



Stage 092: Preparing the Front Right Hydroplane Fin

In this stage you'll prepare the front right hydroplane fin by attaching it to the wheel cover.

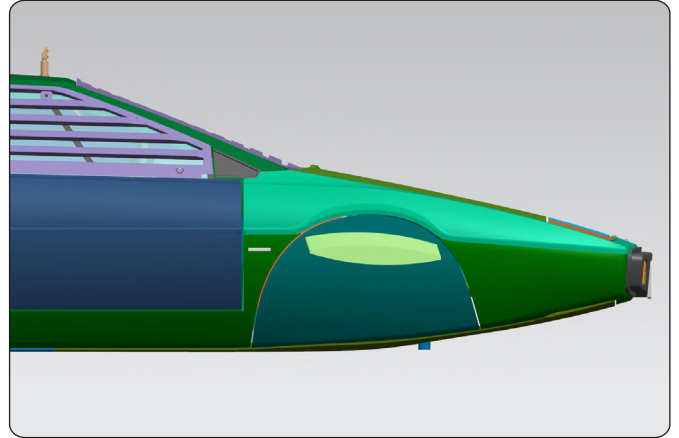

STAGE 092 PARTS LIST

Name
92-A Wheel cover (FR)
92-B Hydroplane fin
PS23 screws x2

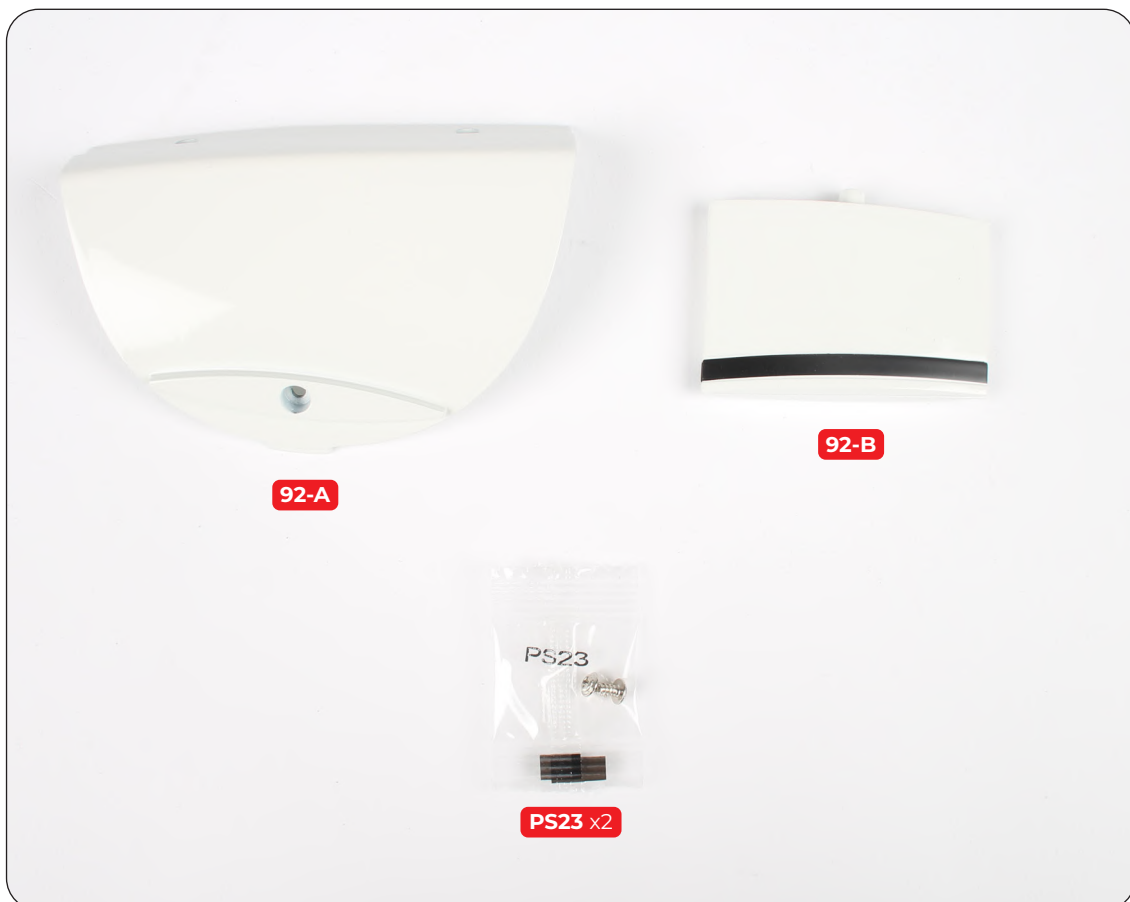

Stage 092: Preparing the Front Right Hydroplane Fin



Align the hydroplane fin (92-B) with the wheel cover (92-A).



Press the parts together.



Secure with a PS23 screw.

Stage 092: Preparing the Front Right Hydroplane Fin

STAGE COMPLETE

