

# Ferrari

## 250 GTO



# Pack 11

## BUILD INSTRUCTIONS

**STAGE 81: DASHBOARD AND  
FIREWALL COMPONENTS**

**STAGE 82: THE BATTERY**

**STAGE 83: THE ROOF AND  
OTHER PARTS OF THE BODY**

**STAGE 84: THE DASHBOARD AND  
THE REAR RIGHT WHEEL (1)**

**STAGE 85: THE REAR RIGHT WHEEL (2)**

**STAGE 86: THE REAR RIGHT WHEEL (3)**

**STAGE 87: THE REAR RIGHT WHEEL (4)**

**STAGE 88: THE PEDALS**

**STAGE 89: BODY FLOOR AND BODY**

**STAGE 90: PRINTED CIRCUIT BOARD**

# Advice from the experts

---

To help you get the best out of building the Ferrari 250 GTO, we've prepared a modellers checklist with hints, tips and advice from our experts. The information below is aimed at making your build as enjoyable and professional as possible right from the start.

Have a soft cloth ready to place on your work surface to prevent scratching the paintwork.

Spare screws are included with each part. Occasionally, you may be instructed to keep spare or unused screws for a later stage. Keep these spares in a safe place and label them correctly.

Please make sure you don't mix up the screws. They look quite similar, but the threads do vary slightly. Using the wrong screws may damage the parts.

When securing parts together using multiple screws, fit each screw loosely to ensure all the parts are correctly aligned before gently tightening them firmly, but not overtight, in the order in which you placed them.

The screwdriver can be magnetized by stroking it with a magnet (fridge magnet, etc.) enabling it to hold the screws and make assembly easier.

If a screw is tight going into a metal part, do not force it as you may shear the head off. Remove it and put a tiny smear of Vaseline, soap or light oil on the thread. That will lubricate it and make it easier to drive home.

Only use the correct size screwdriver that fits the screw head firmly.

Use a magnet to help find screws that have fallen on the floor.

Use masking tape to hold parts temporarily in place.

Cut parts from a sprue (framework) with side cutters or a craft knife. Side cutters tend to be easiest.

During the course of this build, you will receive many pieces that you will assemble immediately – following the instructions in the corresponding stage – and other pieces that you should store safely to one side, for use in future assembly stages.

Left and Right! When building your *Ferrari 250 GTO*, the left- or right-hand side refers to that side as if you are sitting in the car.



**WARNING:** Some parts are assembled using magnets. These magnets can cause serious injury if they are swallowed. Keep away from children. If you suspect a magnet has been swallowed, seek medical help straight away.

All parts belong to a kit. Collectors item for adults.

Not suitable for children under 14.

Produced under license of Ferrari S.p.A. The name FERRARI, the PRANCING HORSE device, all associated logos and distinctive designs are property of FERRARI S.p.A. The body designs of the Ferrari cars are protected as Ferrari S.p.A. property under design, trademark and trade dress regulations.

# Stage 81: Dashboard and Firewall Components

In this stage you'll fit further components to your model's dashboard and firewall.



## STAGE 81 PARTS LIST

Name	Name	Name
1 Motor cover	6 Coils - part A	11 Cable 1
2 Windscreen wiper motor	7 Coils - part B	12 Cable 2
3 Motor bracket	8 Switch bracket	13 Cable 3
4 Controls	9 Ignition switch	4 type B screws
5 Ignition coil caps	10 Key	5 type C screws

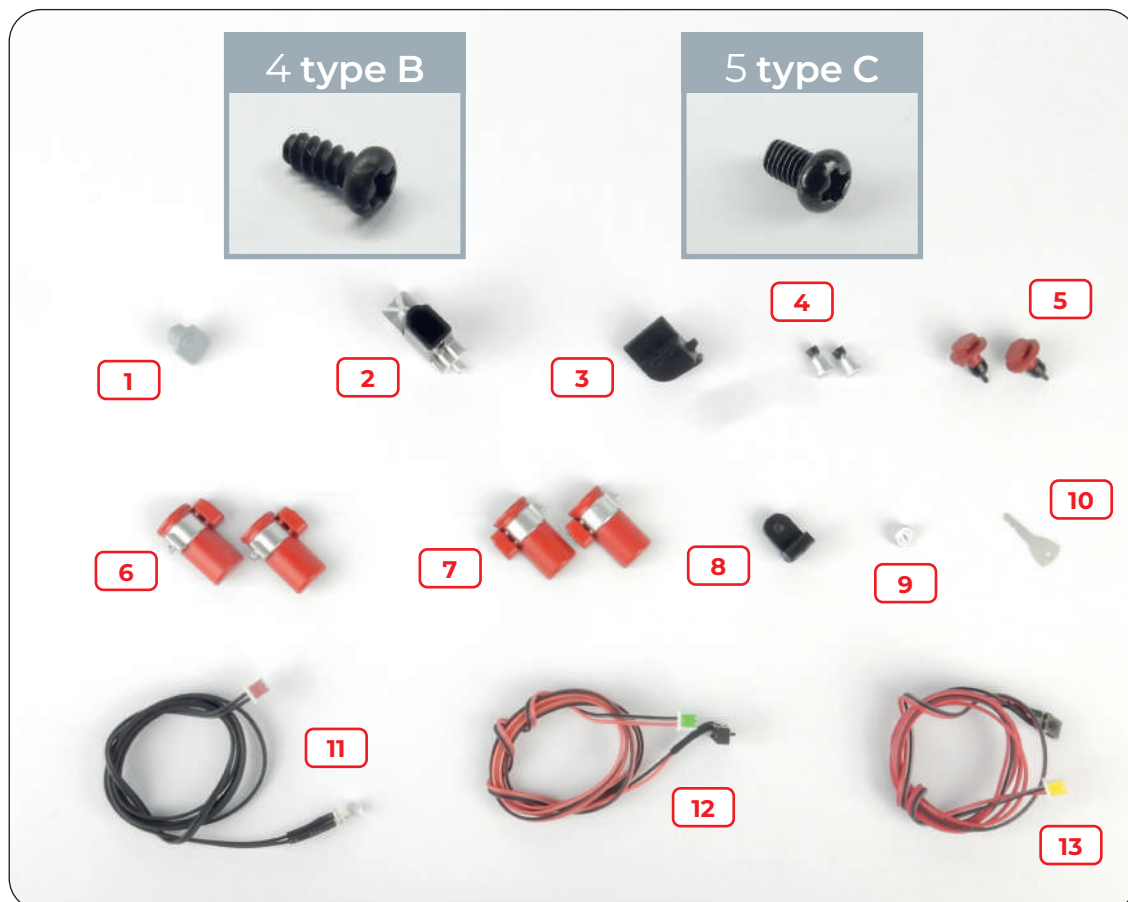

## Stage 81: Dashboard and Firewall Components

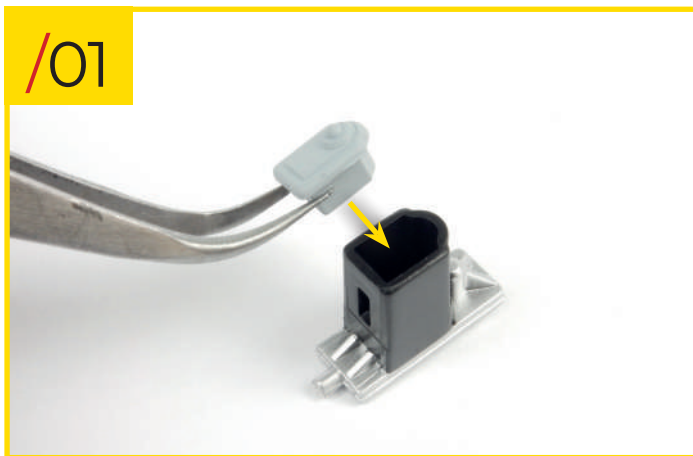

81/01 Fit the cover to the windscreen wiper motor by pressing it into place.



81/02 Retrieve the dashboard support and place the motor bracket into the position indicated in the photo. Secure the pieces together using a type B screw.

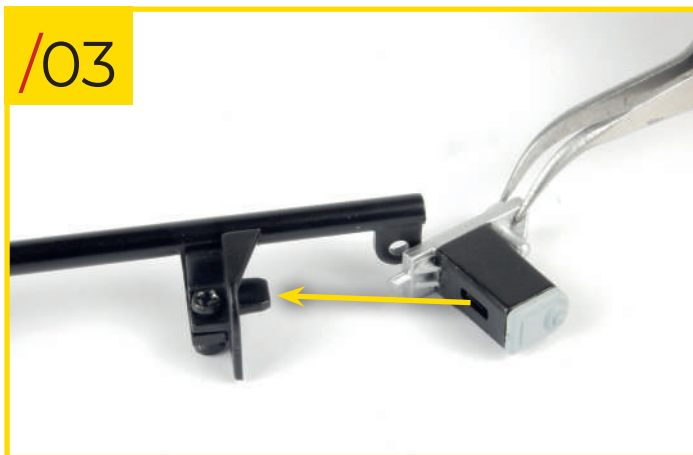

81/03 Fit the windscreen wiper motor to the bracket. Orientate the pieces as shown.

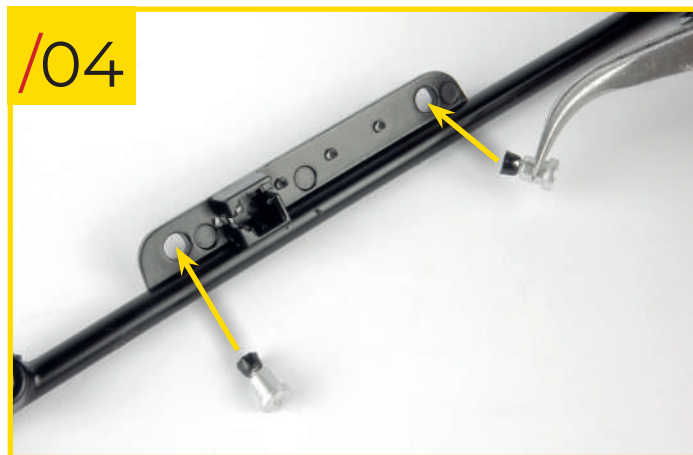

81/04 Working on the rear of the support, insert the two controls into the holes indicated. Do not use glue.

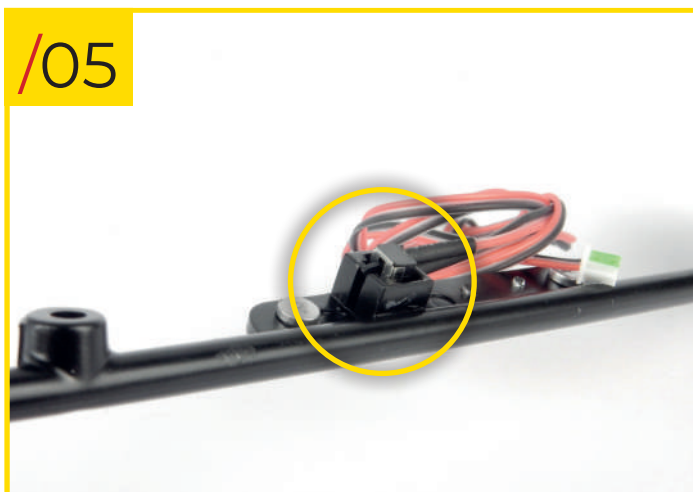

81/05 Insert the switch that's attached to cable 2 (green connector) into the dedicated position on the rear of the support. Orientate the pieces as shown in the photo.

## Stage 81: Dashboard and Firewall Components

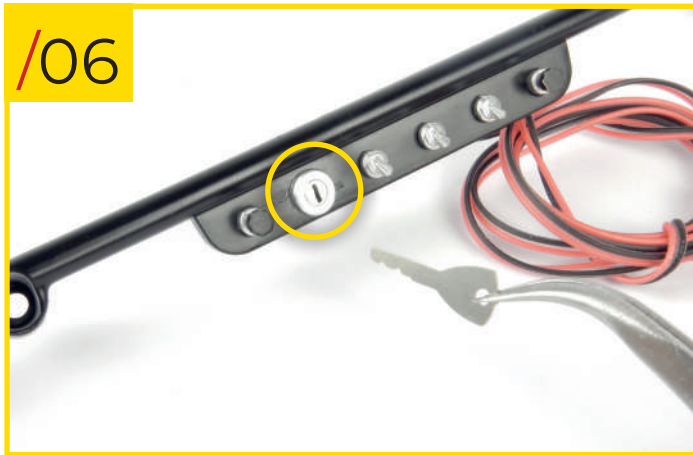

81/06 Fit the ignition switch to the front of the support and insert the key into the hole. The components are very fragile, be careful not to damage them.



81/07 When your model is complete, inserting the key will turn on the power.

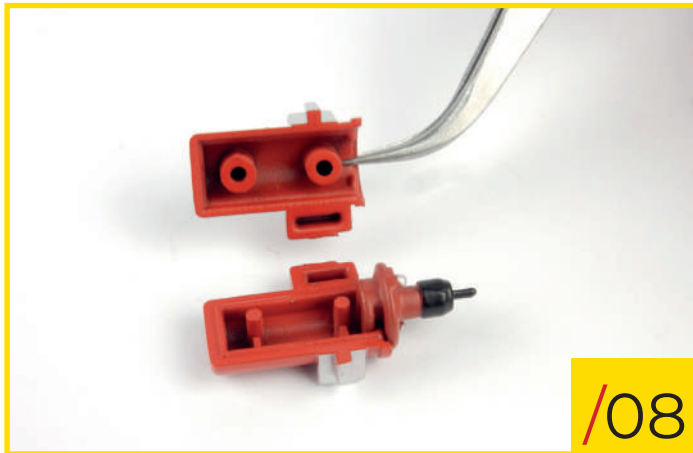

81/08 Fit one of the caps into its position on the inner side of part A of one of the coils and complete the coil by adding part B. Orientate the pieces as shown in the photo.



81/09 Repeat to assemble the second ignition coil.

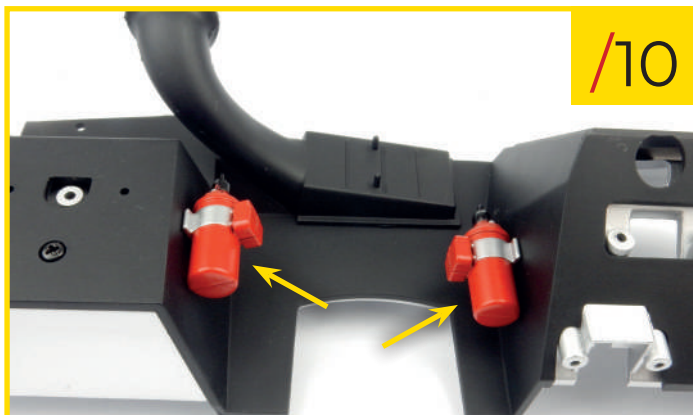

81/10 Retrieve your model's firewall assembly and fit the two coils to its inner side. Some light pressure will need to be applied to fit the pieces together.

## Stage 81: Dashboard and Firewall Components



81/11 Retrieve the dashboard assembly and insert the LED light on Cable 1 (red connector) into the hole on the rear of the instrument panel. Be careful not to damage the cable.

81/12 Fit the switch that's attached to cable 3 (yellow connector) to the switch bracket, orientating the pieces as shown.

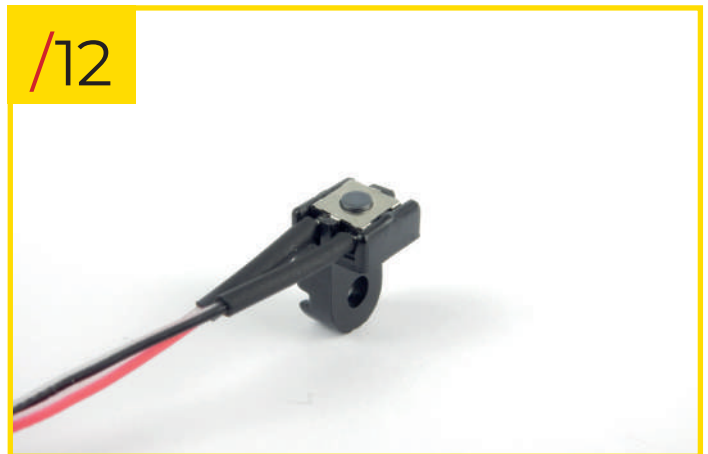

STAGE 81 IS COMPLETE  
Here's how your model's dashboard and firewall look at the end of this assembly session.

## Stage 82: The Battery

In this stage you'll work on your model's steering column, you'll also add the battery and other components to the firewall.



### STAGE 82 PARTS LIST

Name	Name	Name
1 Battery tray	5 Handle	9 Reservoir cover
2 Battery	6 Air duct	10 Brake fluid reservoir
3 Battery cover	7 Panel with VIN plate	
4 Battery terminals	8 Reservoir bracket	3 type B screws

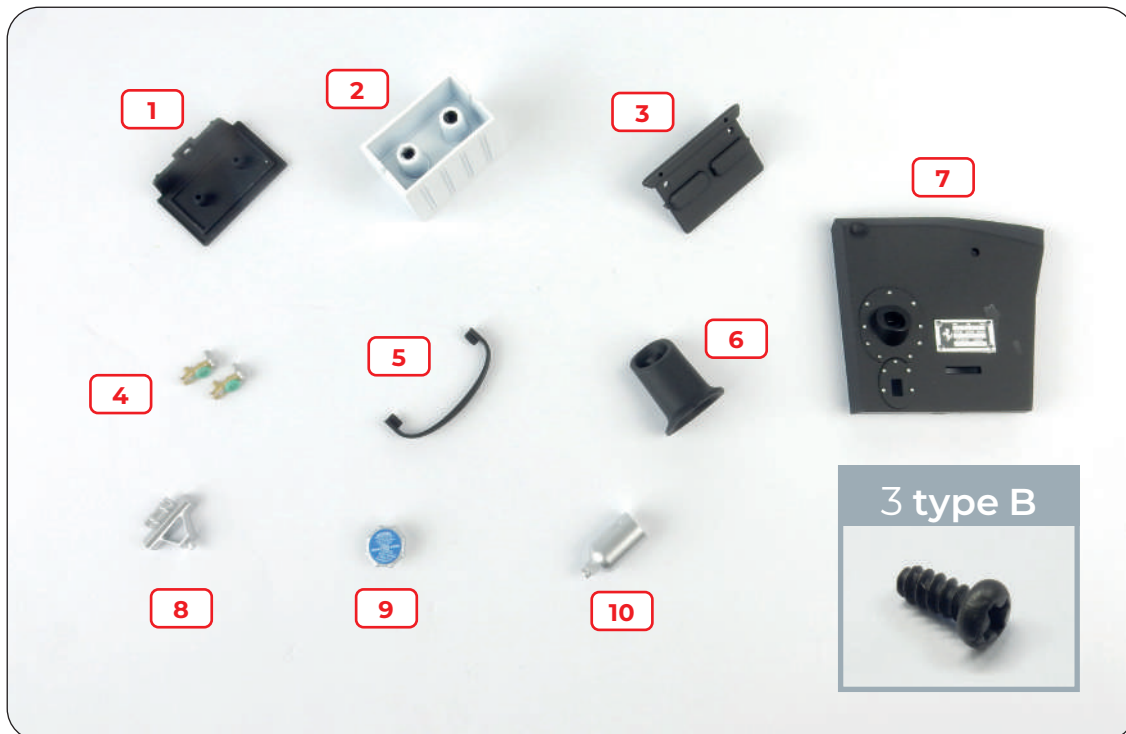

## Stage 82: The Battery

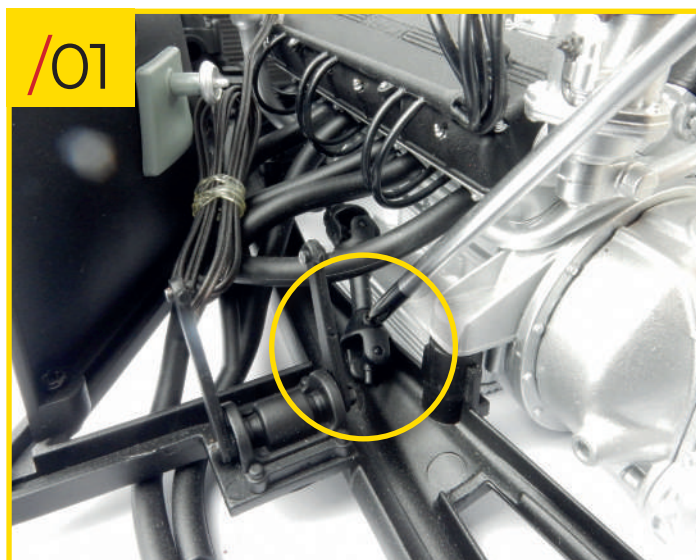

82/01 Retrieve the chassis assembly and remove the screw, the tab at the end of the axle, and the cross-shaped central component from the steering shaft.

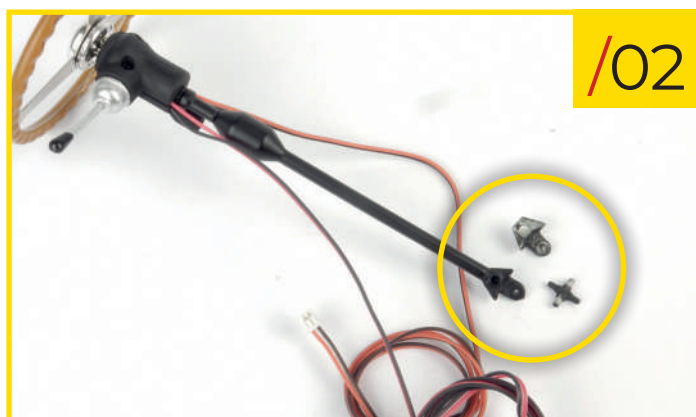

82/02 Retrieve your model's steering assembly and fit the components you removed in step 01 to the end of the steering column.



82/03 Use the screw that you removed in step 01 to fit the tab and central component to the end of the steering column. Look at the photo to check that you've fitted the pieces together correctly.



82/04 To avoid damaging the horn cable in the forthcoming assembly steps, we recommend that you push it towards the steering wheel by about 0.5-1 cm.

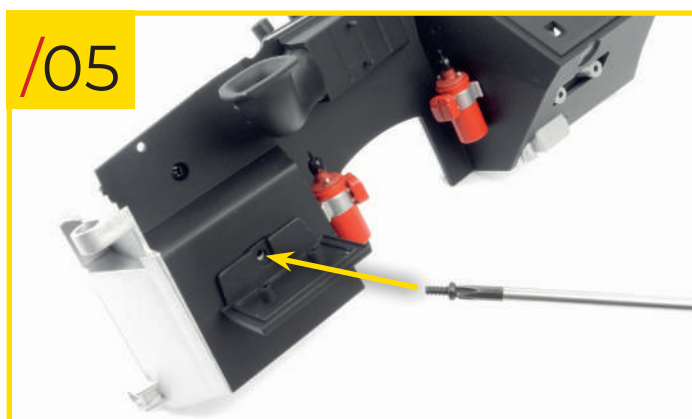

82/05 Retrieve the firewall and install the battery tray into the position shown. Use a type B screw to secure the pieces together.



## Stage 82: The Battery

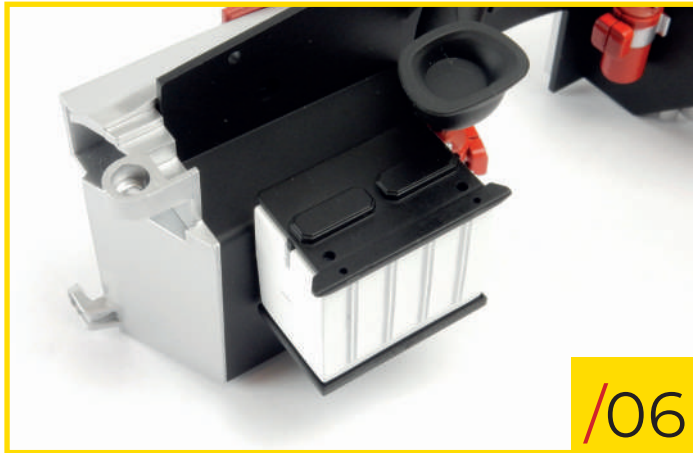

/06

82/06 Fit the battery and its cover as shown.



/07

82/07 Add the two battery terminals and the handle to the assembly.



/08

82/08 Fit the air duct into its dedicated position on the panel.

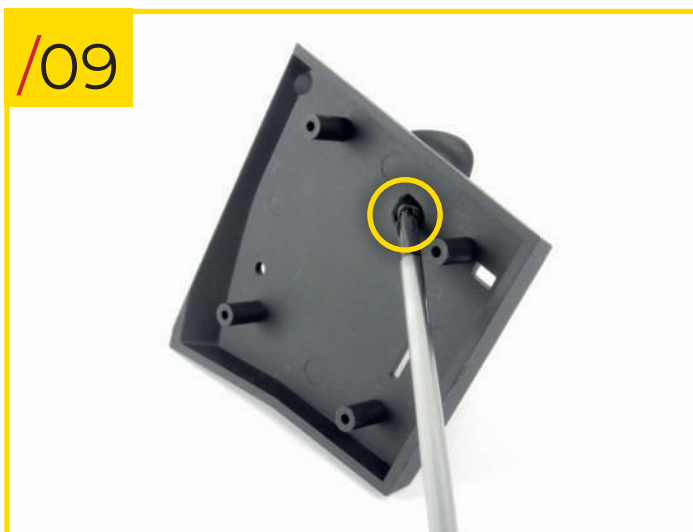

/09

82/09 Working on the underside of the panel, secure the duct to the panel using a type B screw.



/10

82/10 Use a little pressure to fit the panel to the firewall and install the reservoir bracket into the position indicated.

## Stage 82: The Battery

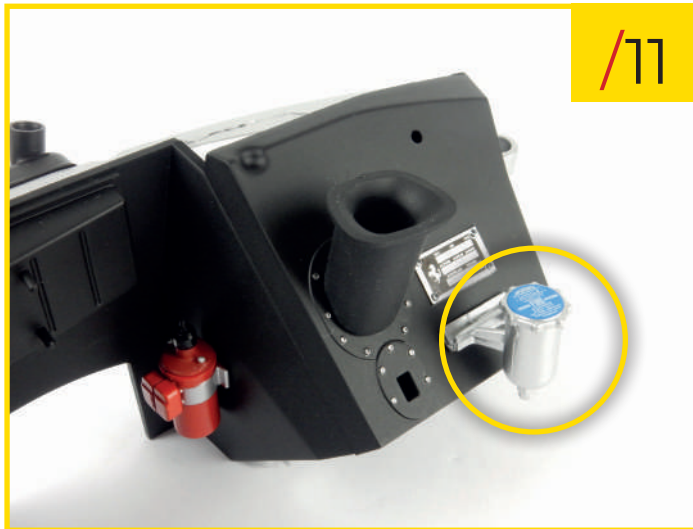

82/11 Fit the brake fluid reservoir to the bracket and add the reservoir cover.

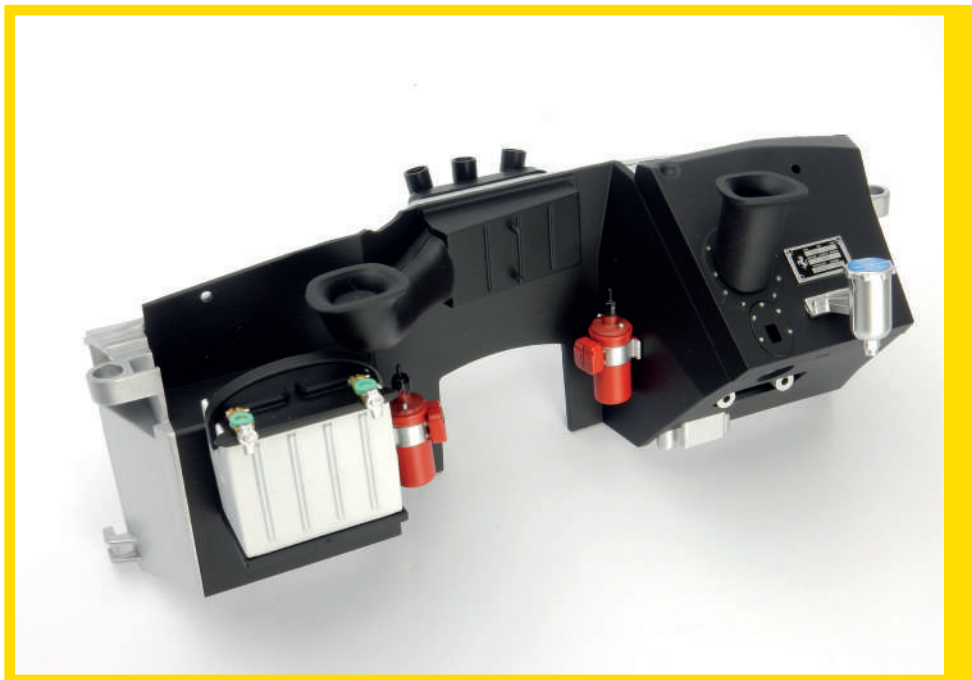

STAGE 82 IS COMPLETE  
Here's how your model's  
firewall looks at the end of  
this assembly session.

## Stage 83: The Roof and Other Parts of the Body

In this stage you'll add the roof to the rear section of your model's body.



### STAGE 83 PARTS LIST

Name	Name
1 Roof	6 LED brake/rear lights
2 Head lining	7 LED indicators
3 Fuel tank filler plate	
4 Fuel tank flap	
5 Stickers	7 type N screws



## Stage 83: The Roof and Other Parts of the Body

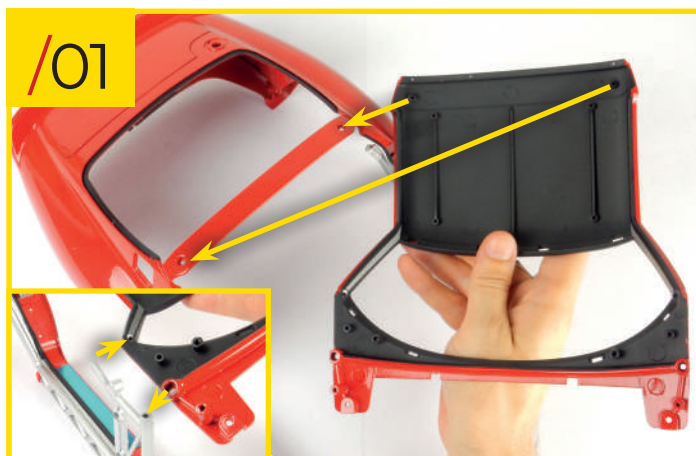

83/01 Fit the roof to the rear section of the body. Use the photo and the shape of the pieces to orientate them correctly.



83/02 Working inside the assembly, screw two type N screws into the holes indicated to secure the pieces together.



83/03 Screw two type C screws (from stages 75 and 76) into the holes indicated.



83/04 Insert the fuel tank filler plate into its dedicated position on the head lining.



83/05 Fit the head lining to the roof and body, use the shape of the pieces to ensure you orientate them correctly. Screw four type N screws into the holes indicated.

## Stage 83: The Roof and Other Parts of the Body

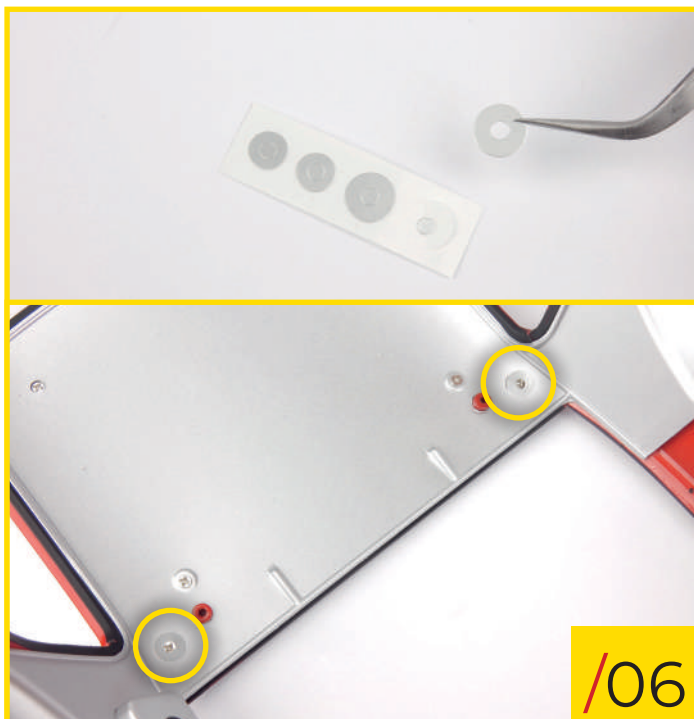

83/06 Detach the two larger stickers from the strip and place them over the heads of the screws used to secure the roof to the body.

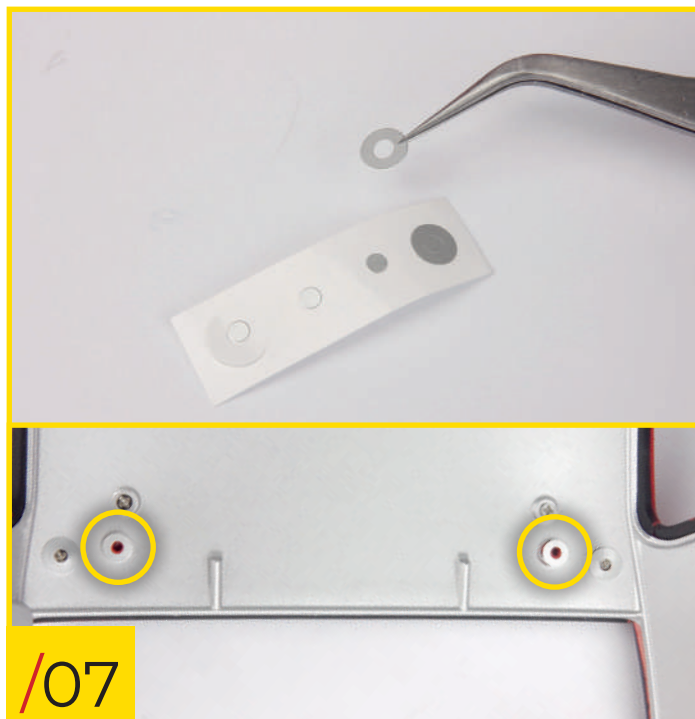

83/07 Similarly, detach the two smaller stickers from the strip and place them over the two raised holes highlighted in the photo.



83/08 Retrieve the roll-bar that you received with stage 75 and place it inside the body, orientating it as shown.

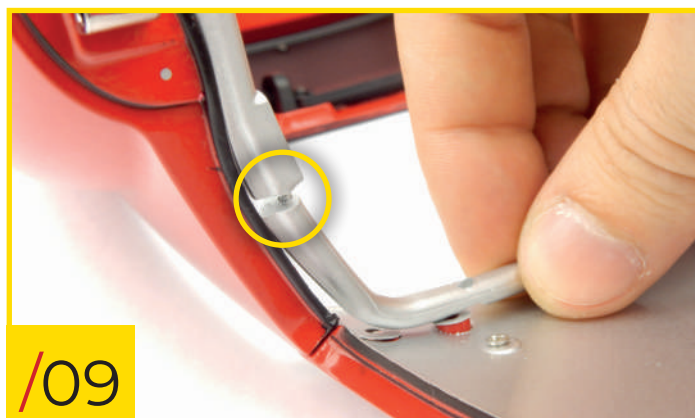

83/09 Introduce the studs on the sub-frame to the holes at the end of the roll-bar, but don't push them all the way in.

## Stage 83: The Roof and Other Parts of the Body

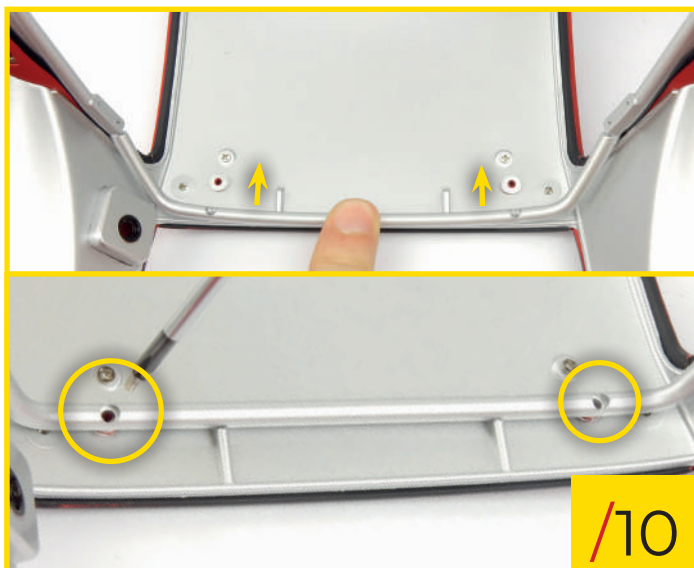

83/10 Push the roll-bar inwards until its holes line up with the raised holes on the roof. Push upwards to insert the sub-frame studs completely and then screw two type N screws (step 75) into the holes indicated.

83/11 Press the fuel tank flap onto the body.

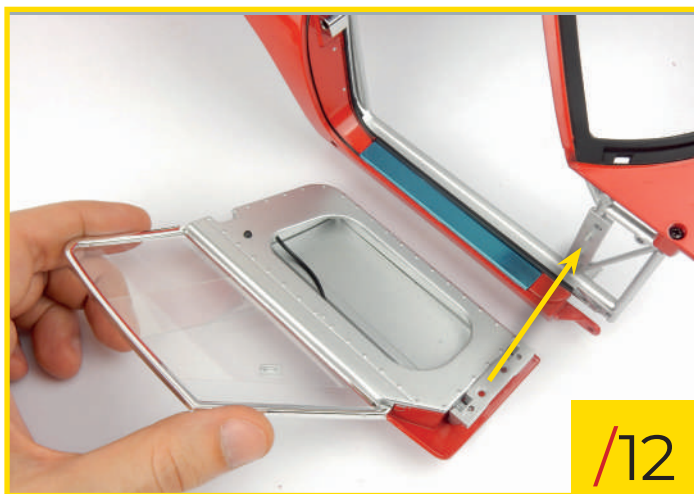

83/12 Retrieve the right door and fit it to the body. Insert the sub-frame studs into the respective holes in the door hinge.

## Stage 83: The Roof and Other Parts of the Body

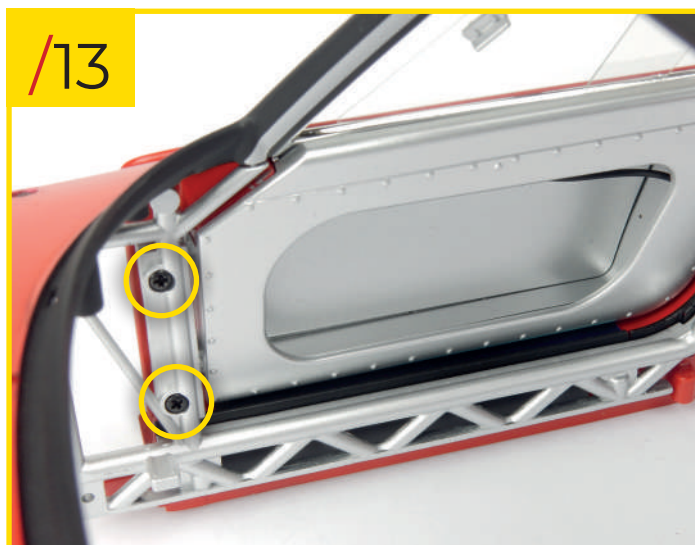

83/13 Screw two type C screws (from stages 75 and 76) into the holes indicated. Repeat steps 12 and 13 to fit the left door to the body as well.



83/14 Insert the LED indicators (orange connector) into their respective slots on the inside of the rear of the body, indicated by the circles in the photo. Now insert the LED brake/rear lights (red connector) into their respective slots, indicated by the arrows.



STAGE 83 IS COMPLETE  
Here's how your model's  
body looks at the end of  
this stage.

## Stage 84: The Dashboard and the Rear Right Wheel (1)

In this stage you'll fit the dashboard and steering wheel inside your model's body and you'll start assembling the rear right wheel.



### STAGE 84 PARTS LIST

Name	Name
1 Inner wheel rim	5 Type C hub
2 Spoke retainer ring 1	6 Type A spokes
3 Type B hub	7 Type B spokes
4 Type A hub	

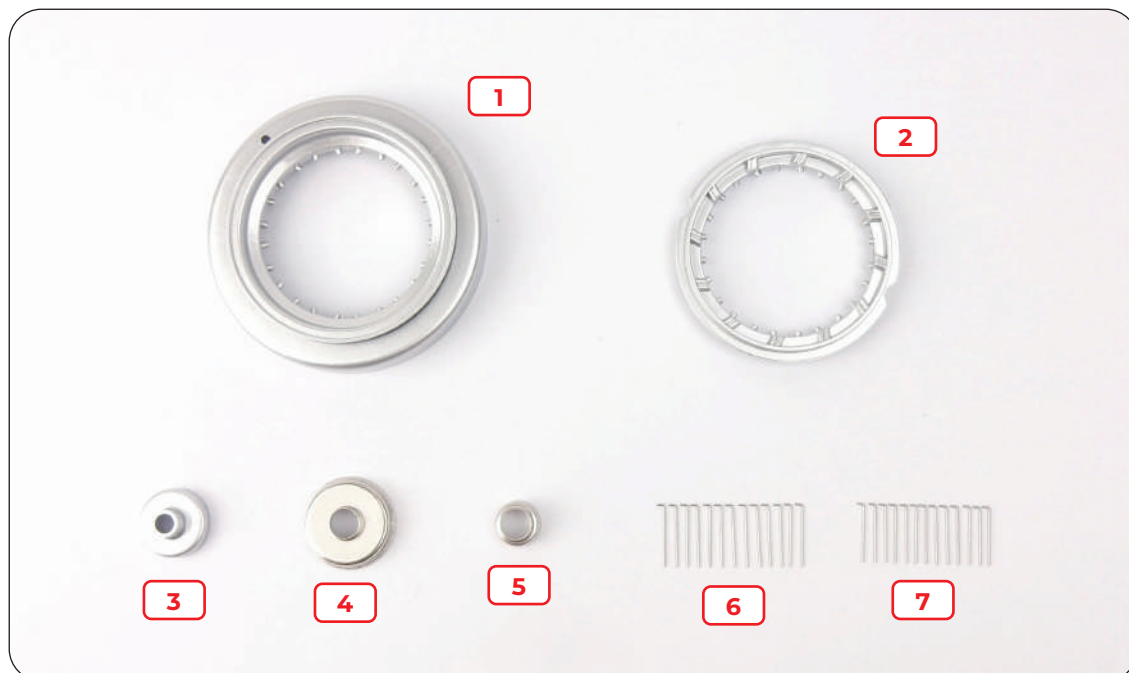



## Stage 84: The Dashboard and the Rear Right Wheel (1)



84/01 Install the rear view mirror that you received with stage 79 into its dedicated position on the inside of the roof. Don't remove the blue film for now, it will help protect the surface of the mirror during future assembly sessions.



84/02 Retrieve the dashboard and fit it into its position inside the body. Use two type C screws (from stage 81) to secure it in place.

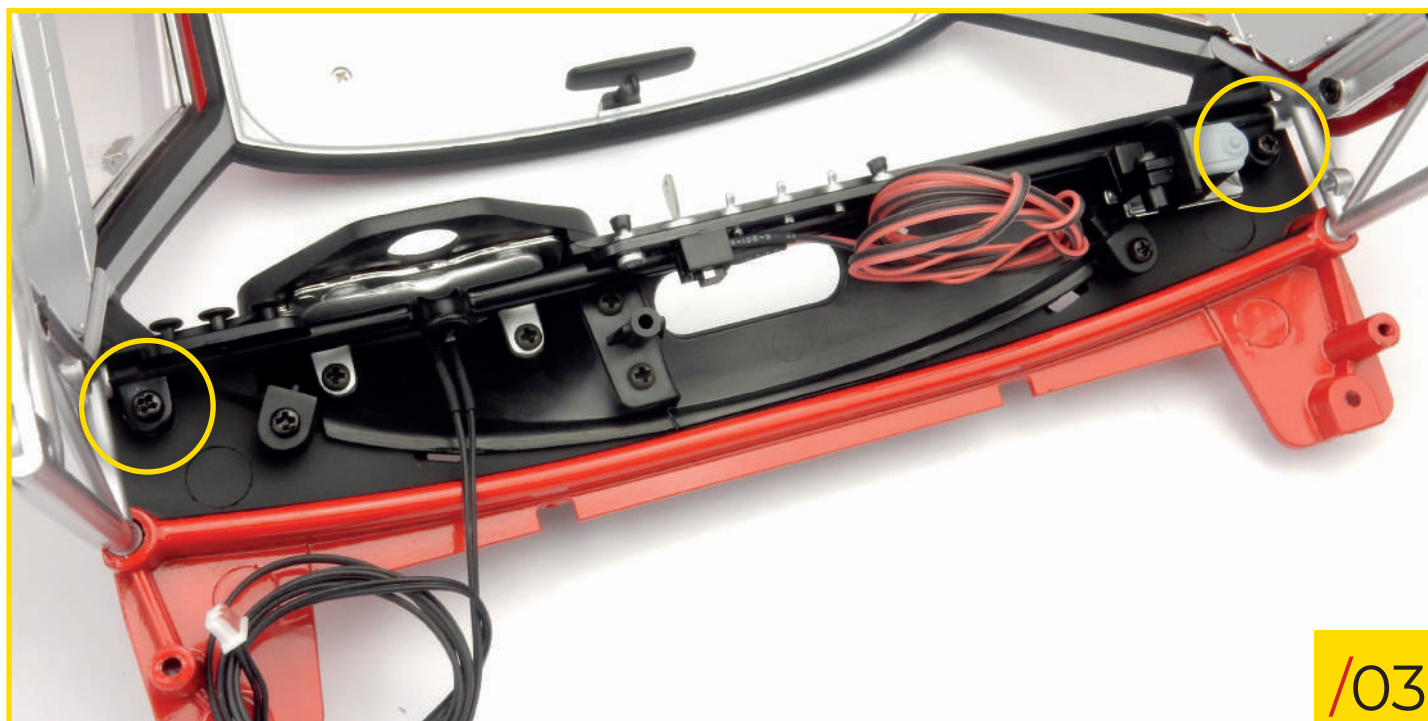

84/03 Also retrieve the dashboard support and install it as shown in the photo. Secure the pieces together using another two type C screws (stage 81).

## Stage 84: The Dashboard and the Rear Right Wheel (1)

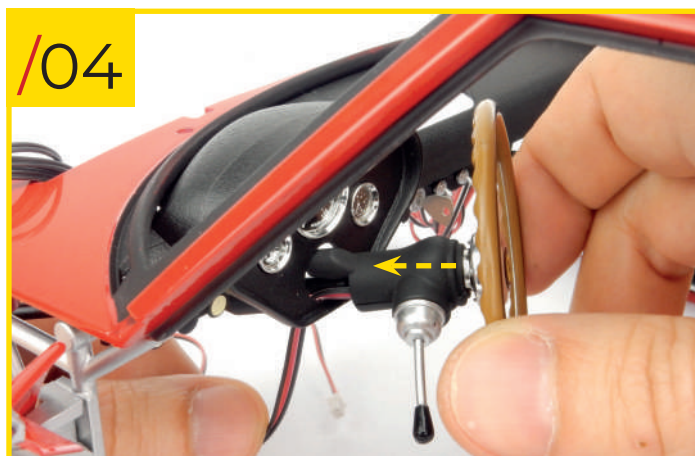

84/04 Retrieve the steering wheel and insert the steering column, with both cables, into the dedicated hole in the dashboard.

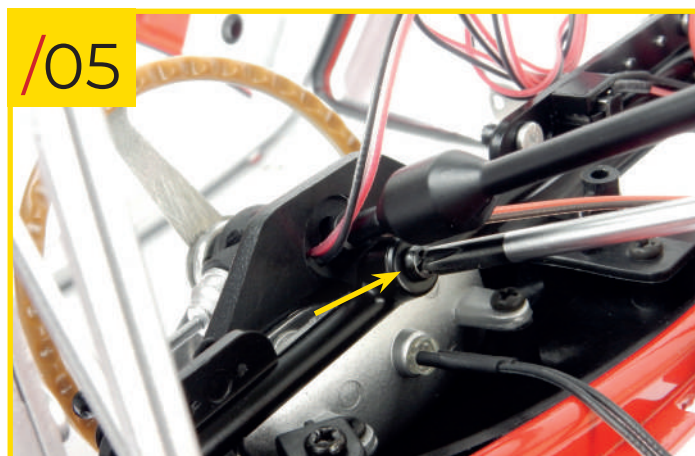

84/05 Working on the underside of the dashboard, screw one type B screw (stage 81) into the hole indicated to secure the pieces together.

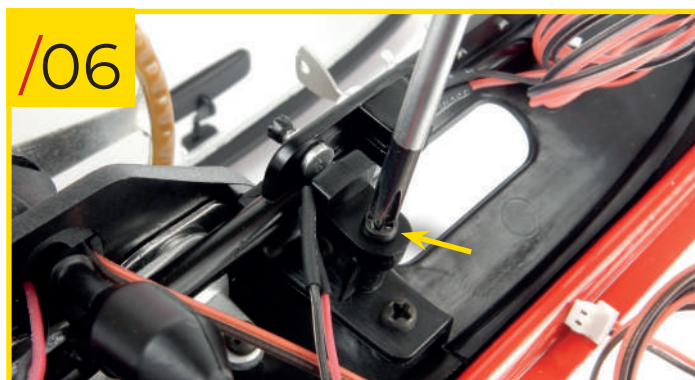

84/06 Retrieve the switch bracket that you assembled in stage 81 and install it into its position on the underside of the dashboard, so that it corresponds with the control positioned between the steering wheel and the key. Secure it into position using a type B screw (stage 81).

84/08 As you did with the other wheels, put the rim on the assembly jig. Before proceeding with the assembly, we recommend that you stick a small piece of double-sided sticky tape to the jig's central stud, or dab a bead of glue on each spoke once they are in position.



84/07 Retrieve the extinguisher (stage 75) and fit it to the sub-frame of the right door, orientating the pieces as shown.

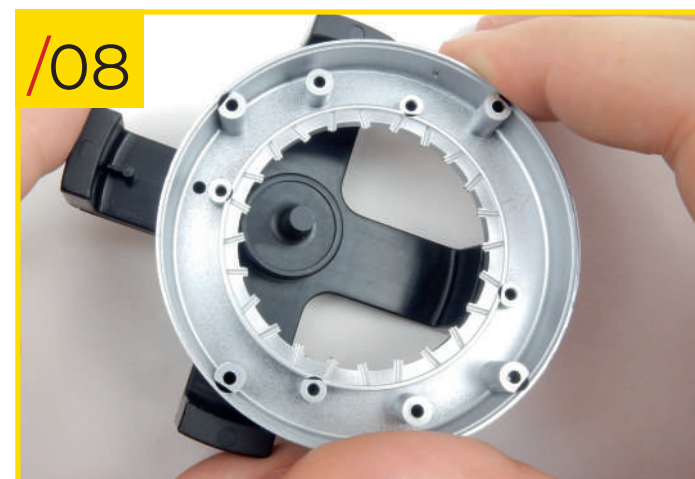

## Stage 84: The Dashboard and the Rear Right Wheel (1)



84/09 Place the type B hub onto the jig's central stud; once in place, put the type A hub on top of it. Before adding the spokes, we recommend that you stick some small strips of double-sided sticky tape to the internal edge of the rim, or dab a bead of glue on each spoke once they are in position.

84/10 Position the type B spokes (they are shorter than the type A ones) by inserting their hooked end into the lower row of holes in the type A hub. Place the straight end of the spokes onto the corresponding notch on the edge of the rim (on the double-sided sticky tape). Always leave an empty hole between each spoke.

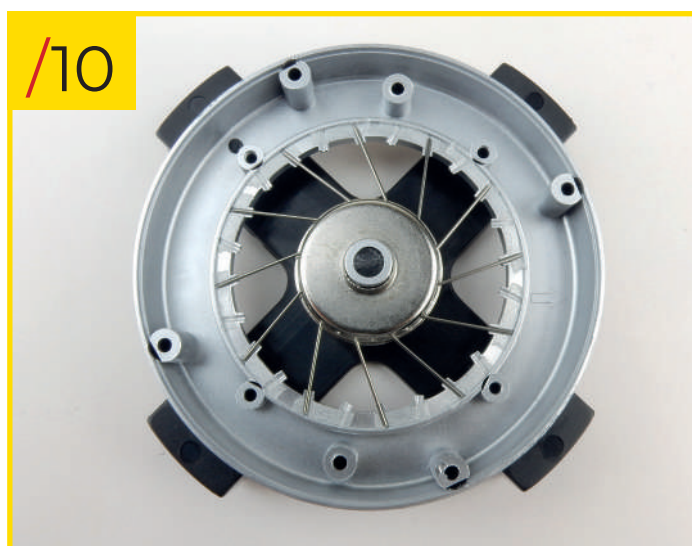

84/11 Now position the type A spokes (they are longer than the type B ones) by inserting their hooked end into the upper row of holes immediately to the left of the type B spokes, making sure they pass over the spokes inserted into the lower row of holes. Always leave an empty hole between each spoke as before.

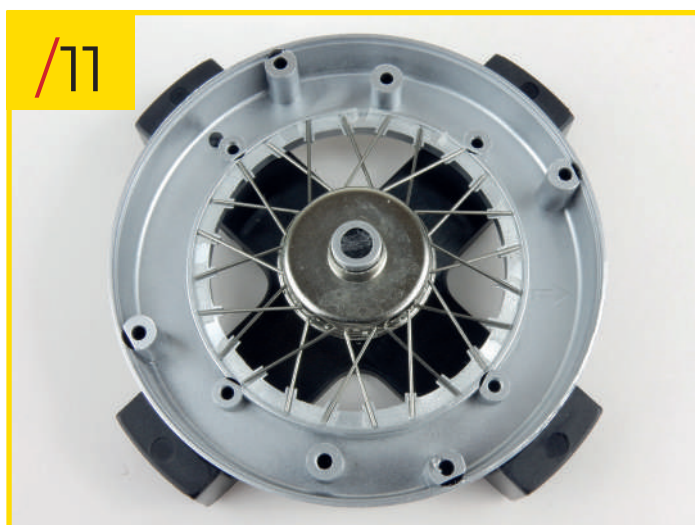

## Stage 84: The Dashboard and the Rear Right Wheel (1)

84/12 Finally, fit the spoke retainer ring 1 onto the internal edge of the rim. Use the photo and the arrows printed on the pieces to fit them together correctly.

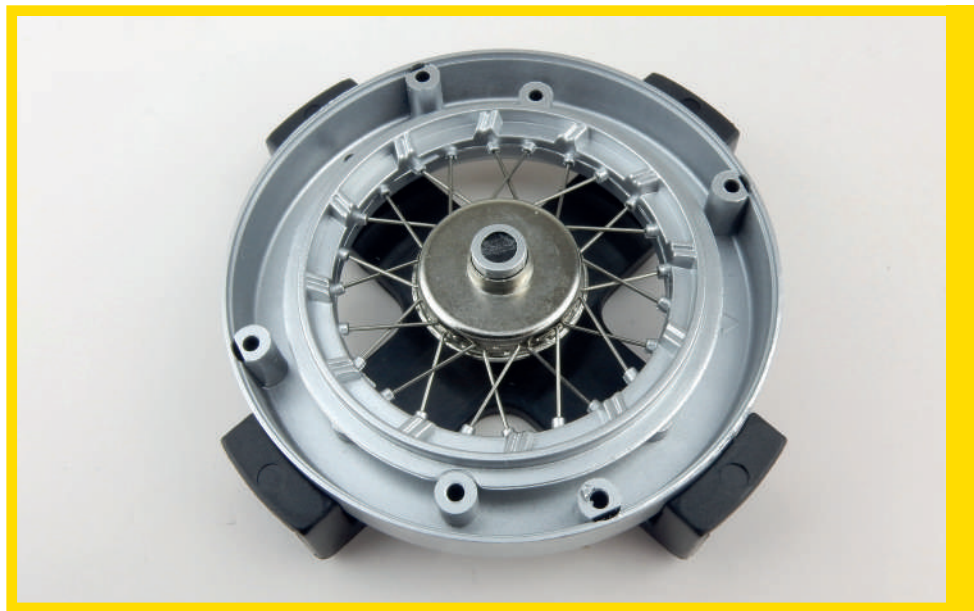
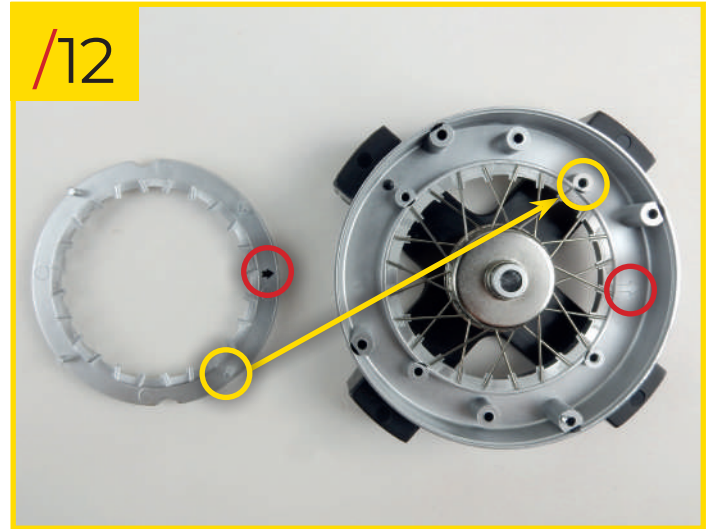

STAGE 84 IS COMPLETE  
Here's how the rear right wheel looks at the end of this stage.

## Stage 85: The Rear Right Wheel (2)

In this stage you'll continue assembling your model's rear right wheel.



### STAGE 85 PARTS LIST

Name	Name
1 Spoke retainer ring 2	3 type B screws
2 Type A spokes	

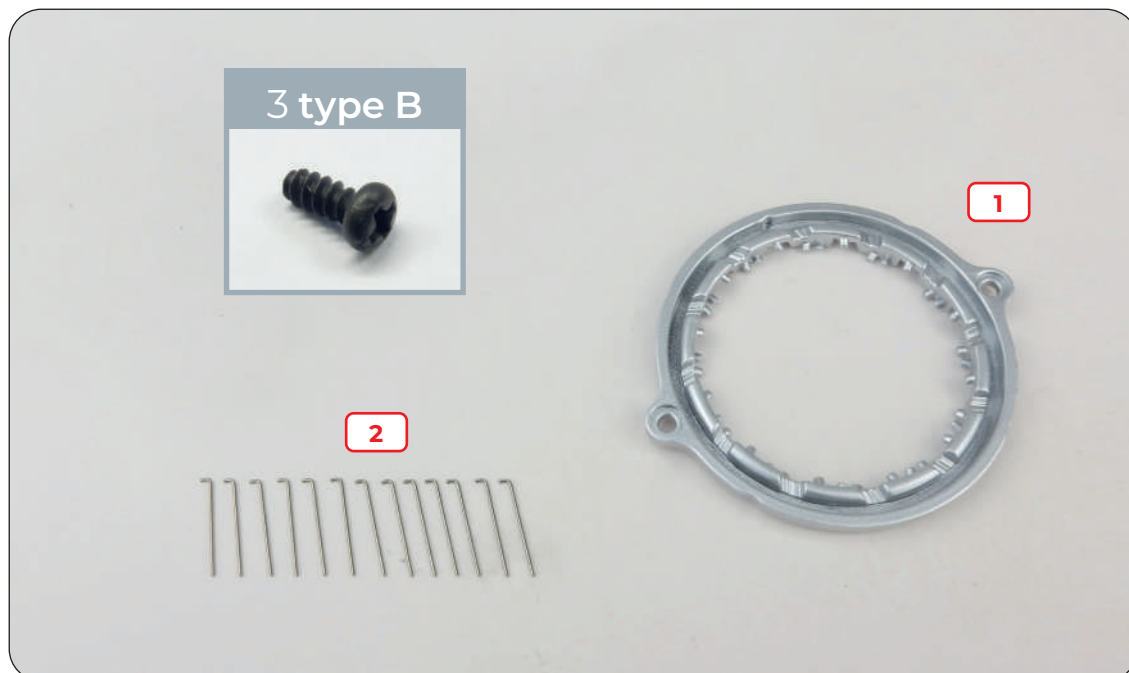

## Stage 85: The Rear Right Wheel (2)



85/01 Place the rear right wheel that you assembled in stage 84 on your work surface. Before proceeding, we recommend that you stick small strips of double-sided sticky tape to the side edge of the spoke retainer ring. Alternatively, you can lay all the spokes in position and then dab a bead of glue on each one after step 85/03.

85/02 Insert the hooked end of the type A spokes you received with this stage into the holes remaining in the lower row on the hub. Place the straight end of the spokes onto the corresponding notch on the edge of the spoke retainer ring 1. Use the photo to help orientate the spokes correctly.



85/03 Look at the photo to check that you've correctly installed the type A spokes.

## Stage 85: The Rear Right Wheel (2)

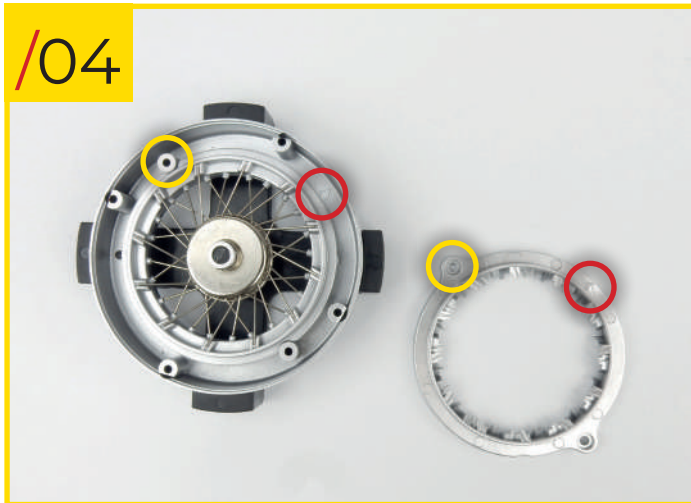

85/04 Add the spoke retainer ring 2 to the rest of the assembly. Use the photo to help fit it correctly.

85/05 Secure the pieces together using two type B screws.



85/06 Look at the photo to check that you've installed all the components correctly.

## Stage 85: The Rear Right Wheel (2)

---

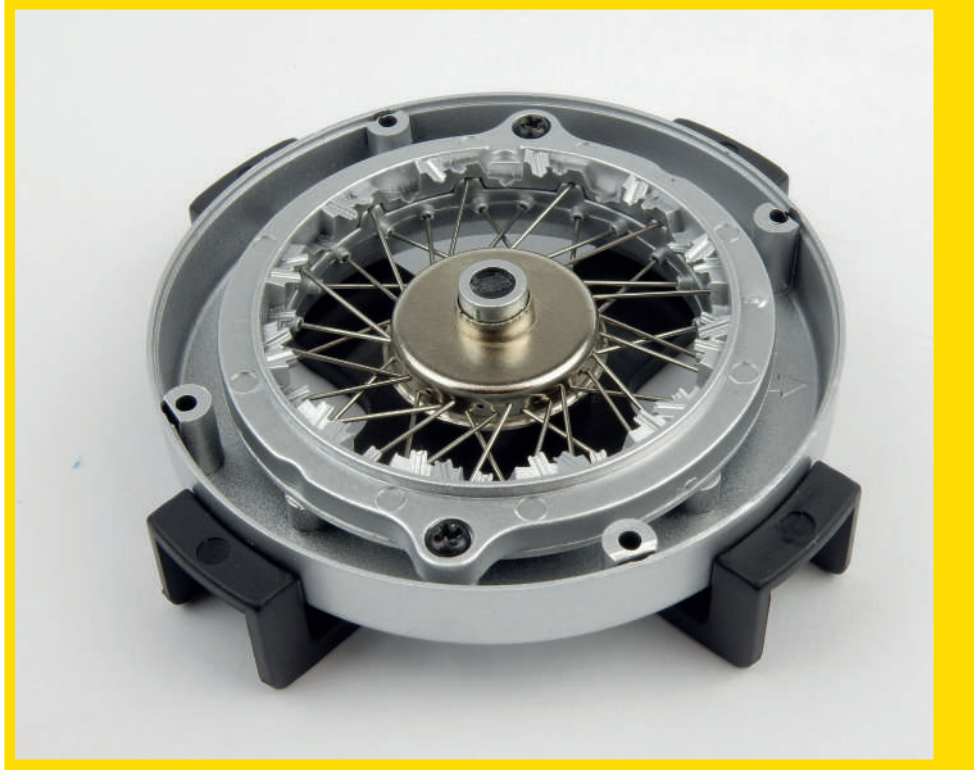

STAGE 85 IS COMPLETE  
The rear right wheel is  
almost finished.



## Stage 86: The Rear Right Wheel (3)

In this stage you'll continue assembling your model's rear right wheel. You will then complete it in the following stage.



### STAGE 86 PARTS LIST

Name	Name
1 Outer wheel rim	5 Type C spokes
2 Sealing ring	
3 Washer	
4 Type A spokes	7 type B screws

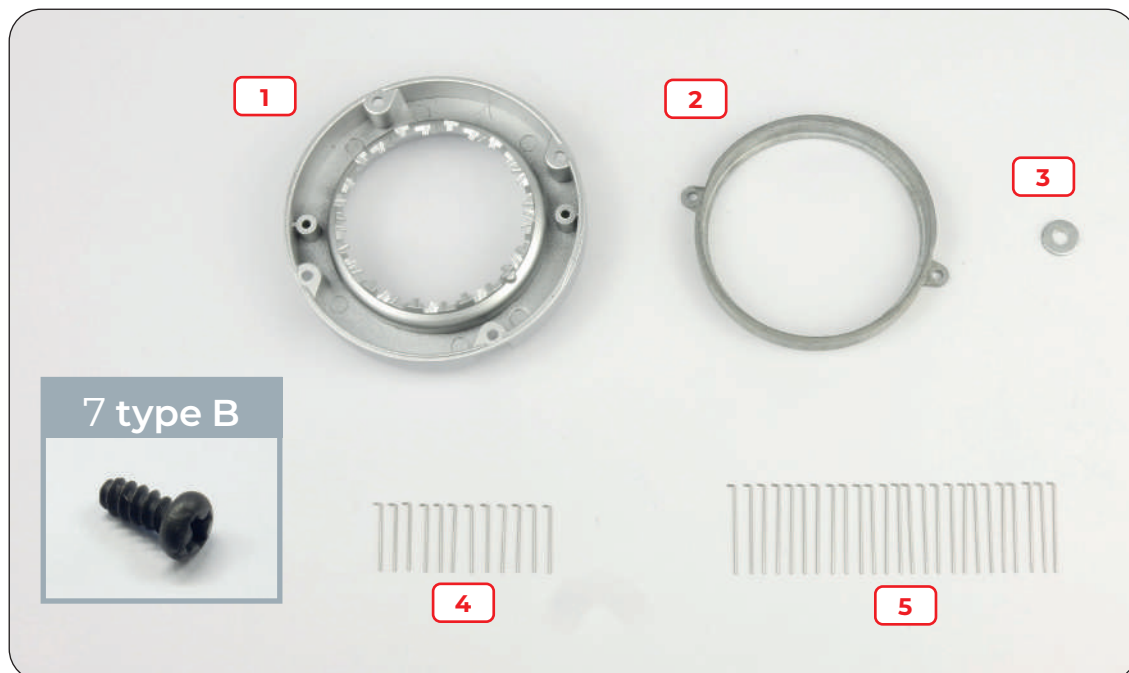

## Stage 86: The Rear Right Wheel (3)

/01



86/01 Place the rear right wheel that you assembled in the previous stages on your work surface. Before proceeding with the assembly, we recommend that you stick small strips of double-sided sticky tape to the side edge of the spoke retainer ring 2. Alternatively, you can add a bead of glue to the spokes once they are in position.

/02



86/02 Insert the hooked end of the type A spokes into the remaining holes in the type A hub. Use the photo to help orientate the spokes correctly and to put their straight end on the corresponding notch on the top level of the housing.



/03

86/03 Once all the type A spokes have been added, position the type C hub that you received with stage 84 as shown in the photo.

/04



86/04 Insert the hooked end of one type C spoke into one of the holes in the lower row on the type C hub.

## Stage 86: The Rear Right Wheel (3)



86/05 Use the photo to help put the straight end of the spoke on the notch on the lower level of the retainer ring. Repeat these steps for the other eleven type C spokes, until all the holes in the lower row on the hub have been filled.



86/06 Now insert the hooked end of one type C spoke into one of the holes in the top row on the type C hub.



86/07 Place the straight end of the spoke onto the corresponding notch on the top level of the retainer ring. Repeat these steps for the other eleven type C spokes, until all the holes in the top row on the hub have been filled.

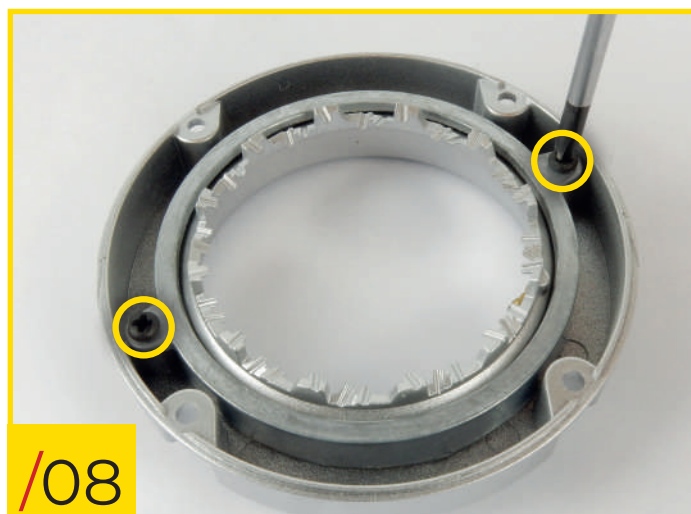

86/08 Fix the sealing ring to the inner edge of the outer wheel rim. Orientate the pieces as shown and secure them together using two type B screws.

## Stage 86: The Rear Right Wheel (3)

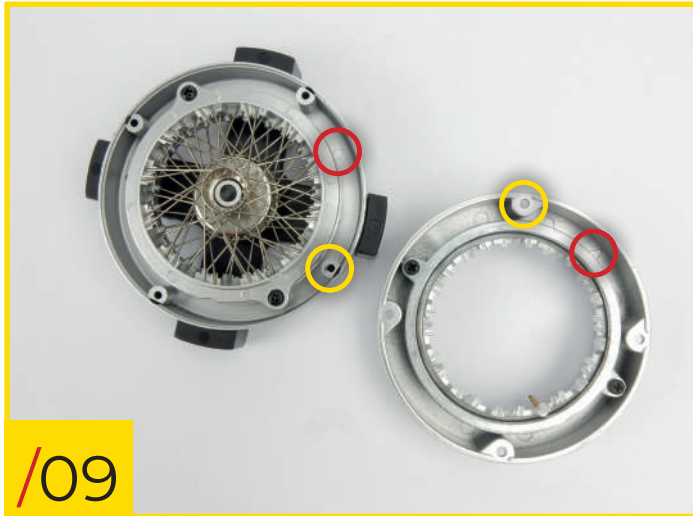

86/09 Fit the outer wheel rim to the rest of the wheel. To line up the fixing holes, look at the photo and match up the circled elements.

86/10 Secure the rim to the rest of the wheel using four type B screws.

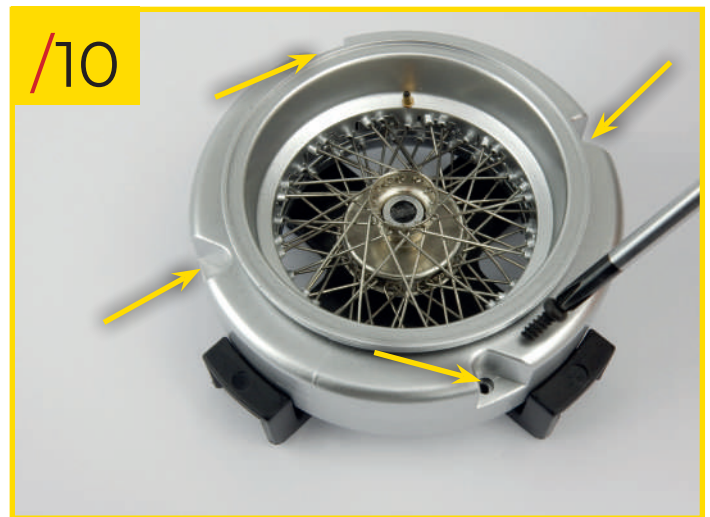

STAGE 86 IS COMPLETE  
Here's how your model's rear right wheel looks at the end of this stage.



## Stage 87: The Rear Right Wheel (4)

In this stage you'll finish assembling the rear right wheel by adding the tyre.



### STAGE 87 PARTS LIST

Name
1 Tyre



## Stage 87: The Rear Right Wheel (4)

/01

87/01 Place the rear right wheel assembly and the washer you received with stage 86 on your work surface. Remove the protective film from one of the sides of the washer, as shown in the round photo.

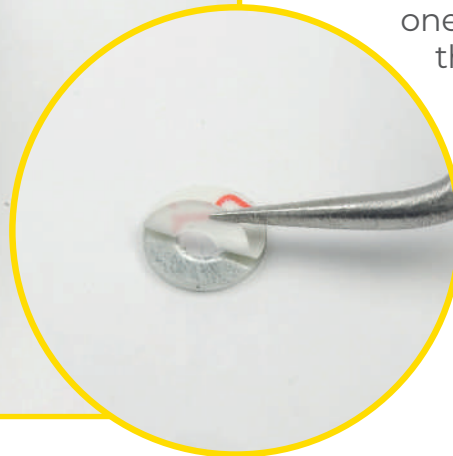

87/02 With the side of the washer that had the film removed facing downwards, insert it into the type C hub, as shown in the photo.

/02



/03



87/03 Look at the photo to check that you've positioned the washer correctly.

## Stage 87: The Rear Right Wheel (4)



87/04 Before adding the tyre to the rest of the wheel, we recommend that you warm it up slightly (using a hair dryer, for example) to make it more malleable.

87/05 Check to make sure that the tyre is malleable enough.



87/06 Slip the tyre onto the rim of the rear right wheel.

## Stage 87: The Rear Right Wheel (4)

---



STAGE 87 IS COMPLETE  
You have now finished  
assembling your model's  
rear right wheel. Keep it  
somewhere safe together  
with the other pieces.



## Stage 88: The Pedals

In this stage you'll assemble your model's pedals and fit them to the firewall. Keep the remaining components in a safe place.



### STAGE 88 PARTS LIST

Name	Name	Name
1 Left wheel arch	7 Accelerator pedal base	13 Brake cable
2 Right wheel arch	8 Brake pedal bracket	14 Accelerator cable
3 Brake pedal	9 Accelerator pedal bracket	
4 Accelerator pedal	10 Coupling	
5 Clutch pedal	11 Prop shaft	5 type B screws
6 Brake pedal base	12 Tab	2 type K screws



## Stage 88: The Pedals

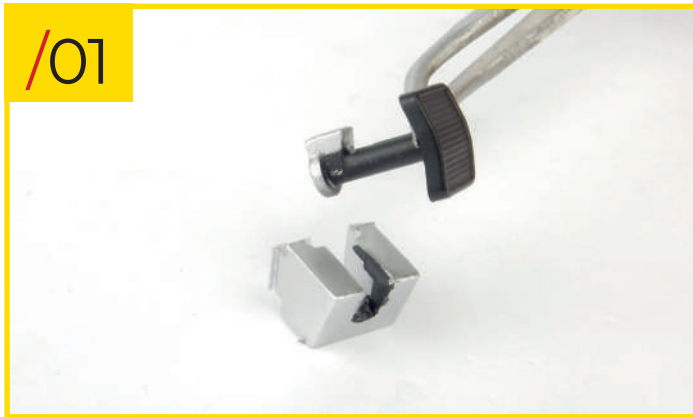

88/01 Fit the brake pedal to its base. Orientate the pieces as shown: the “tooth” on the pedal goes into the corresponding groove in the base.

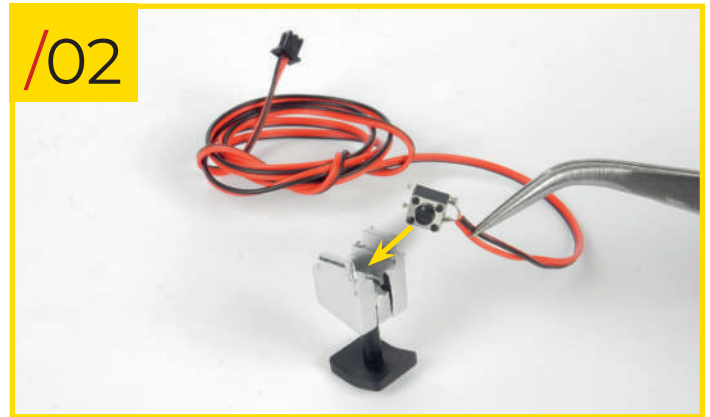

88/02 Fit the brake cable switch (black connector) as shown in the photo. The cable should be facing towards the “tooth” on the pedal.

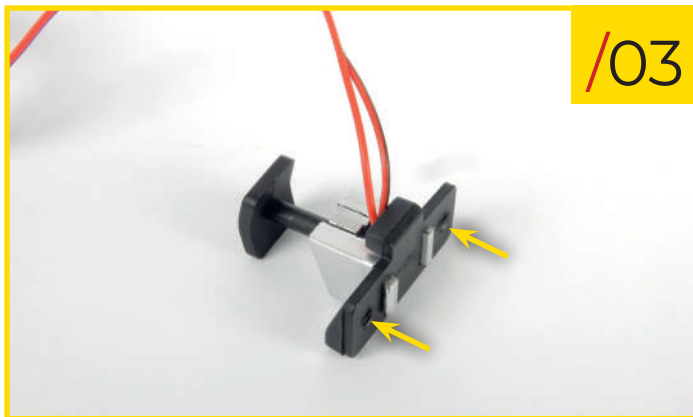

88/03 Fit the brake pedal bracket to the rest of the assembly. Press until the two tabs on the base are fully interlocked.

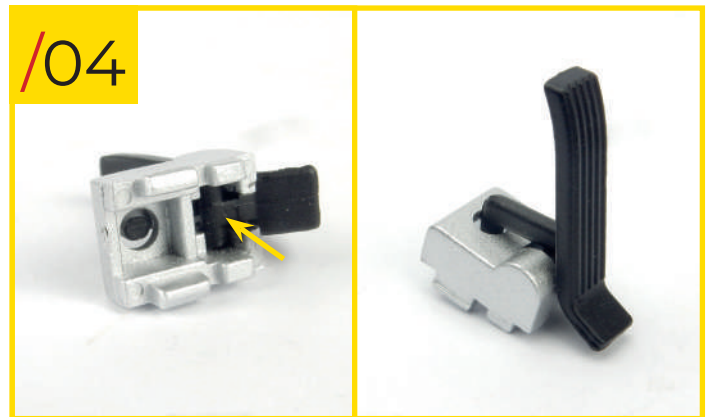

88/04 Now fit the accelerator pedal to its base. Use the photos to help orientate the components correctly.

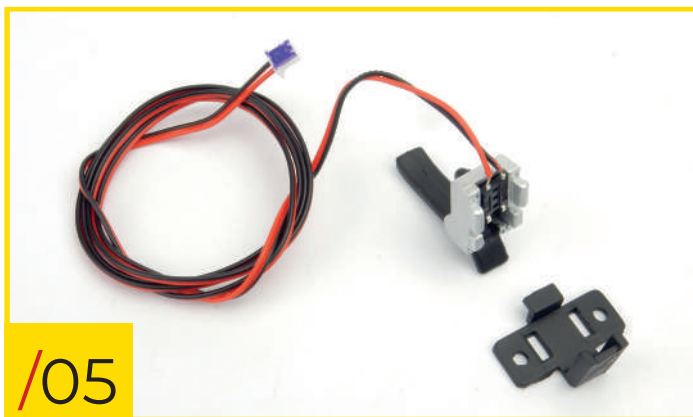

88/05 Place the accelerator cable switch (white and purple connector) into its position. Orientate the pieces as shown in the photo.

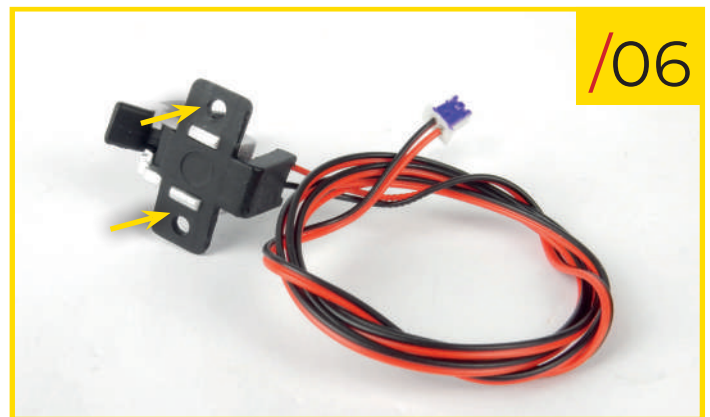

88/06 Fit the accelerator pedal bracket to the rest of the assembly. As before, press until the two tabs on the base are fully interlocked.

## Stage 88: The Pedals

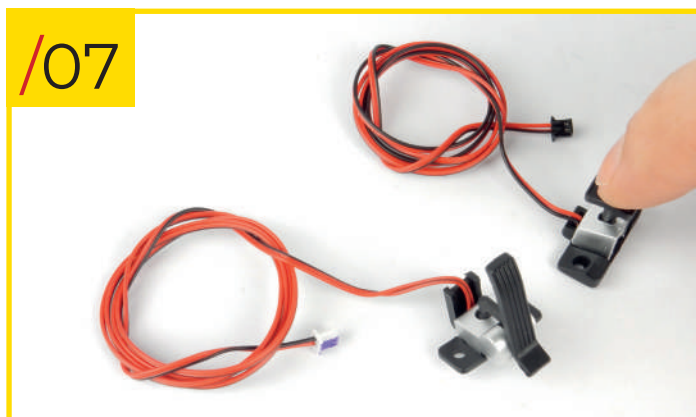

88/07 Press the two pedals you've assembled so far to check that their switches are working properly.

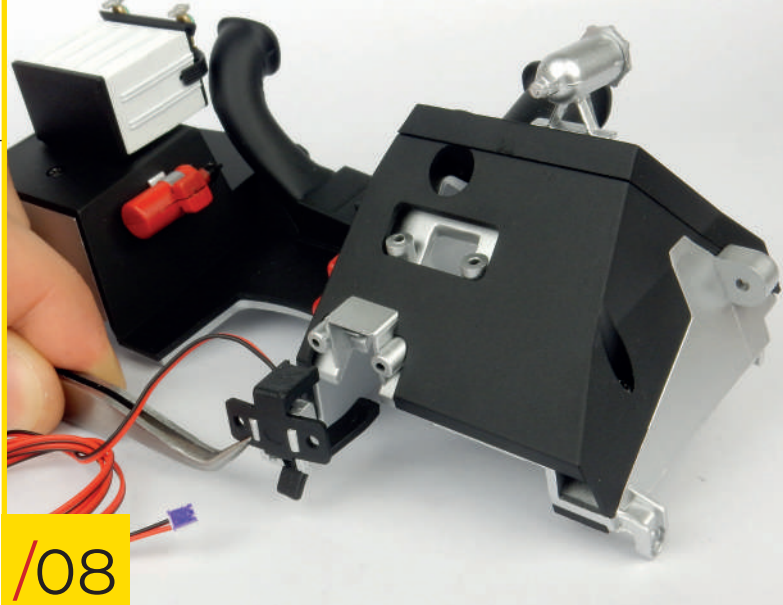

88/08 Retrieve your model's firewall and fit the accelerator pedal assembly into its position. Orientate the pieces as shown.

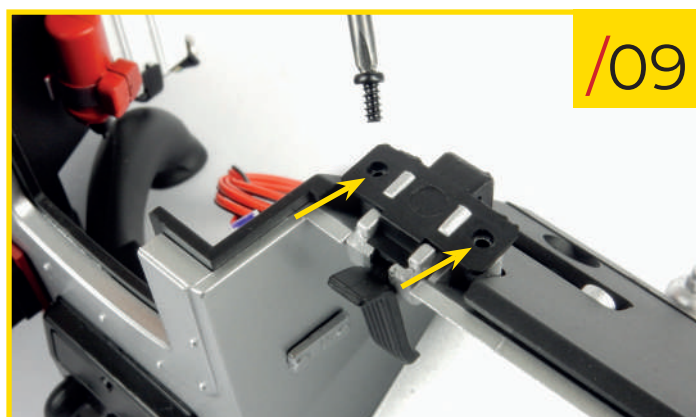

88/09 Screw two type B screws into the holes indicated to secure the accelerator pedal assembly to the rear of the firewall.



88/10 Now fit the brake pedal assembly into its position. Use the photo to help orientate the components correctly.

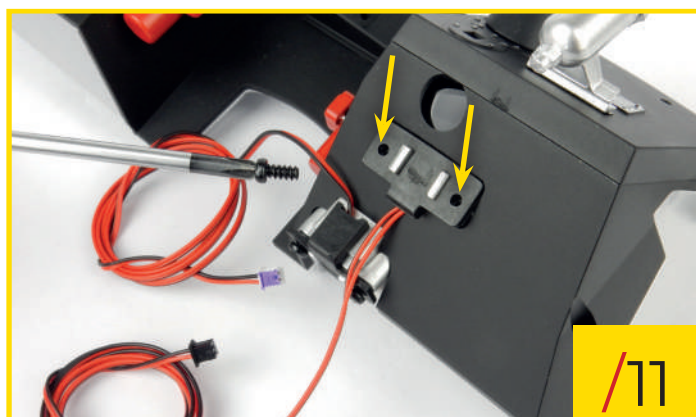

88/11 As before, use two type B screws to secure the brake pedal assembly to the rear of the firewall.



88/12 Fit the clutch pedal into its position on the front of the firewall. There's only one way that the pieces can fit together.

## Stage 88: The Pedals

---



88/13 Finally, insert one end of the prop shaft into the hole in the centre of the coupling.

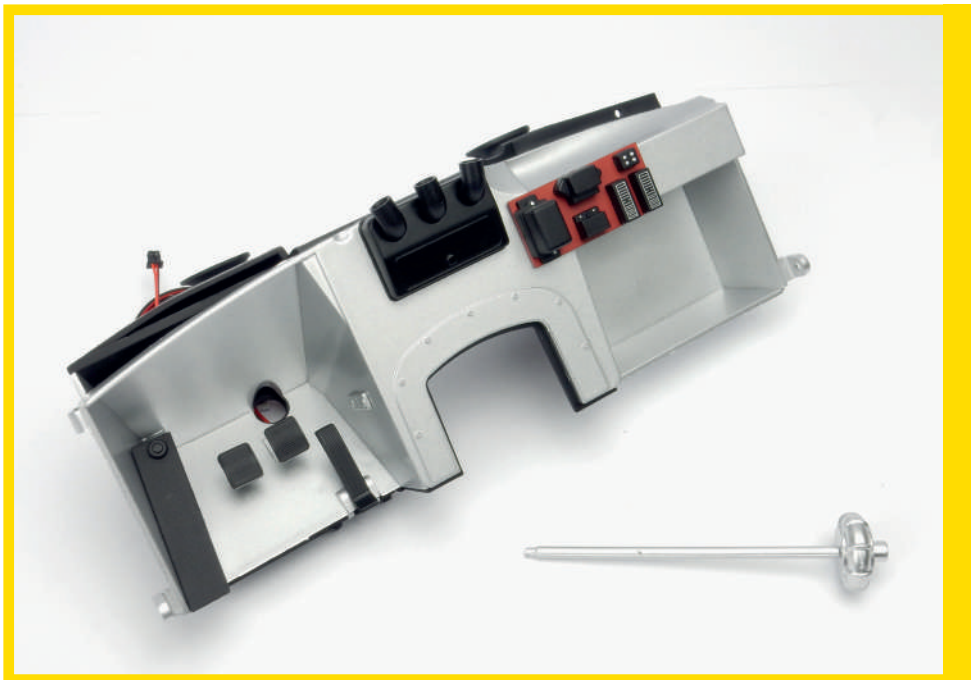

STAGE 88 IS COMPLETE  
Here's the result of this assembly session. As always, keep everything somewhere safe together with the other pieces and the components that you haven't used during this session.

## Stage 89: Body Floor and Body

In this stage you'll add various components to the rear section of your model's body. Keep the battery tray components in a safe place, you'll need them for a later stage.



### STAGE 89 PARTS LIST

Name	Name	Name
1 Battery tray	6 Support rod	15 type B screws
2 Battery tray base	7 Left plate	15 type C screws
3 Cover	8 Right plate	3 type L screws
4 Short bracket	9 Cover screw	
5 Long bracket	10 Washer	

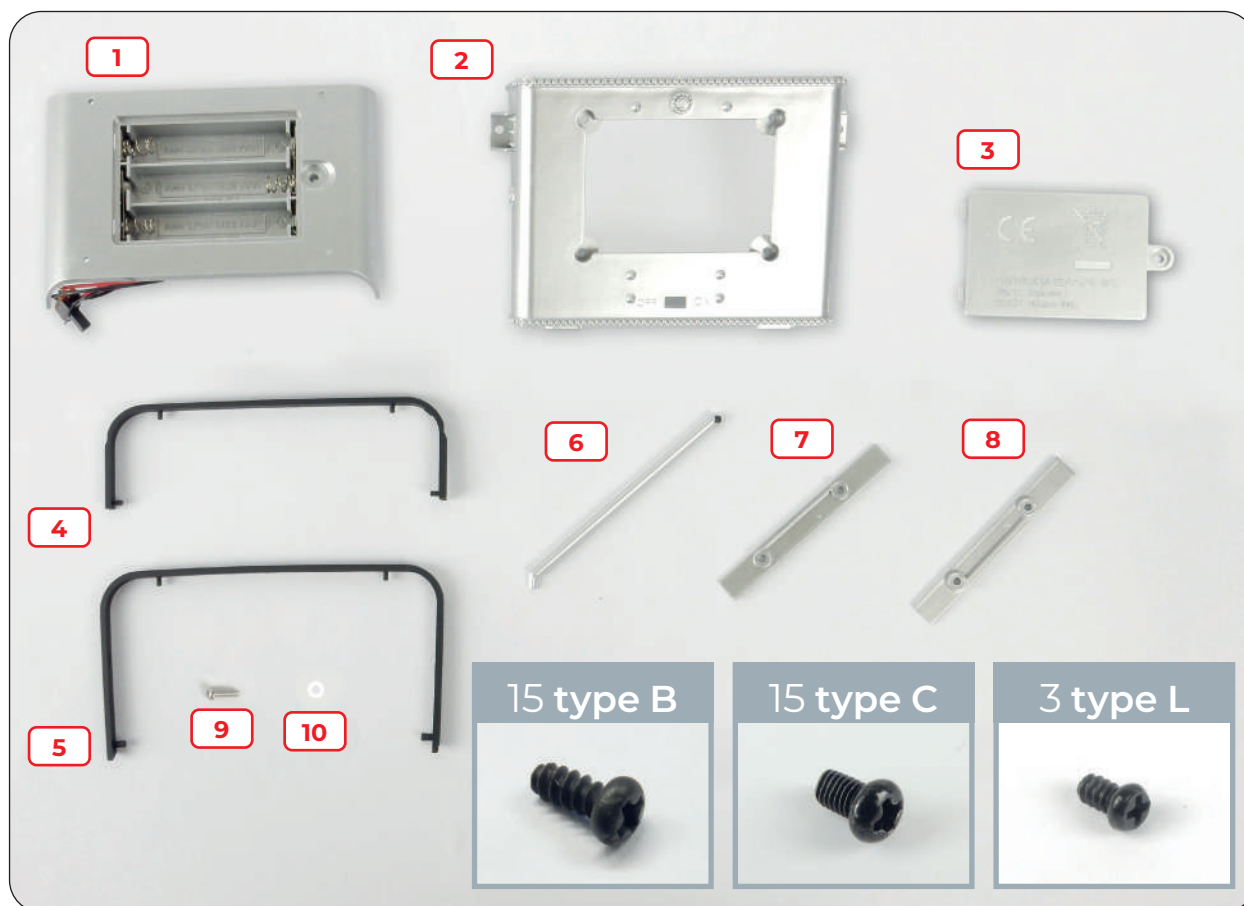

## Stage 89: Body Floor and Body

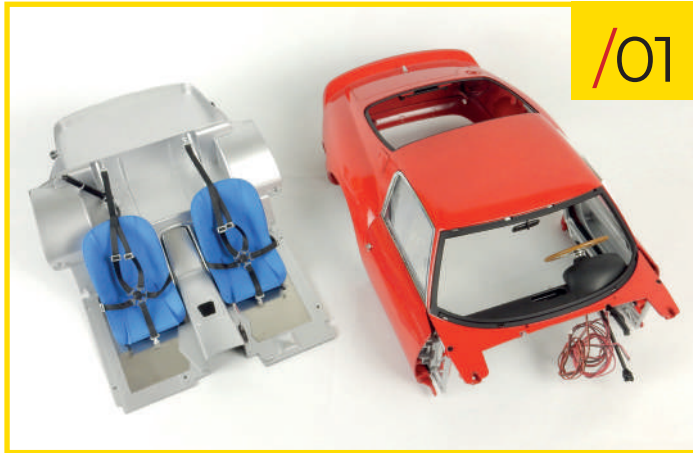

89/01 Place the rear section of the body and the body floor on your work surface.

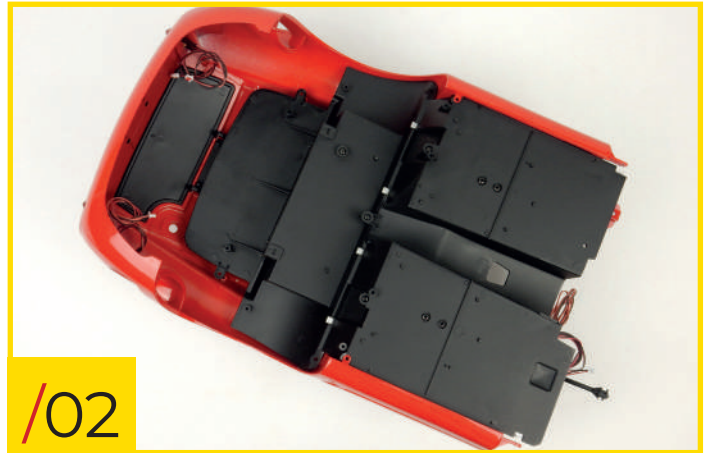

89/02 Fit the two assemblies together, using their shapes to orientate them correctly.



89/03 Push all the components up against each other and insert the end of the oil inlet hose into the hole in the reservoir.

89/04 Start securing the body floor to the body by screwing four type C screws into the holes indicated by the arrows in the photo.

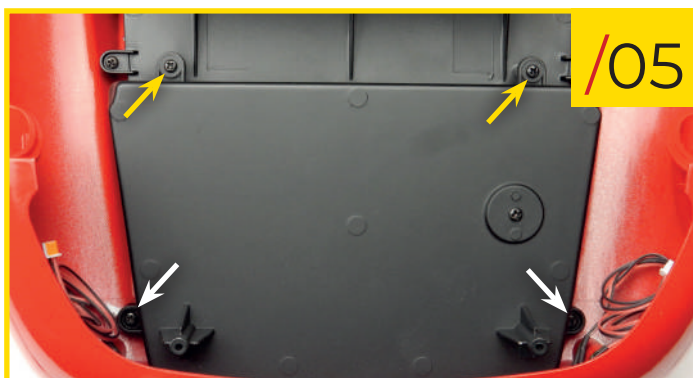

89/05 Retrieve the boot frame that you worked on in stage 75 and fit it into its position. Secure it in position with two type B screws (yellow arrows) and two type C screws (white arrows).

## Stage 89: Body Floor and Body

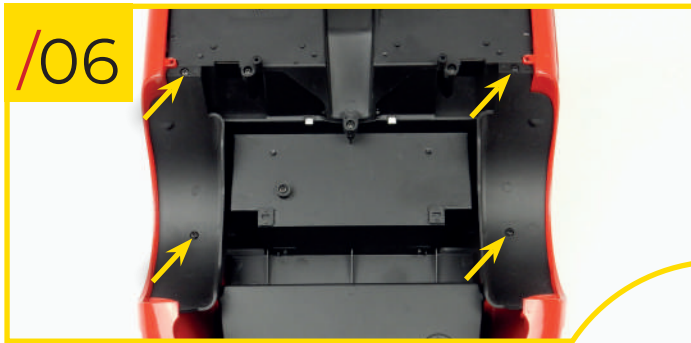

89/06 Retrieve the two wheel arches from stage 88 and fit them as shown. Insert the tabs on the wheel arches into the dedicated holes (round photo) and secure them to the body using four type B screws.



89/07 Fit the support rod into the position indicated in the photo, on the right side of the passenger compartment. Orientate the pieces as shown.

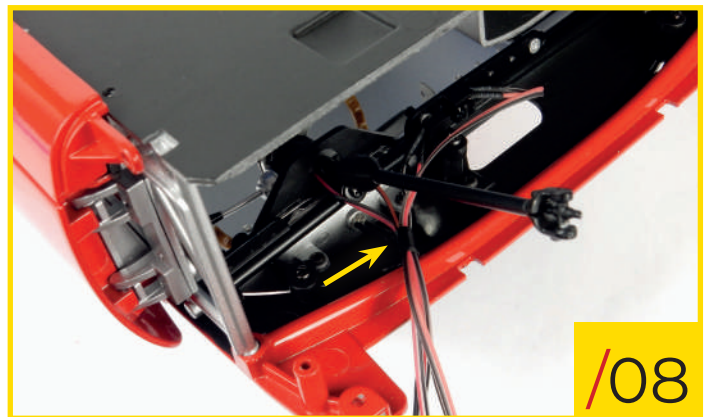

89/08 To make the next steps easier to complete, we recommend that you use some tape or a cable tie to group and tie together the cables coming from the dashboard.

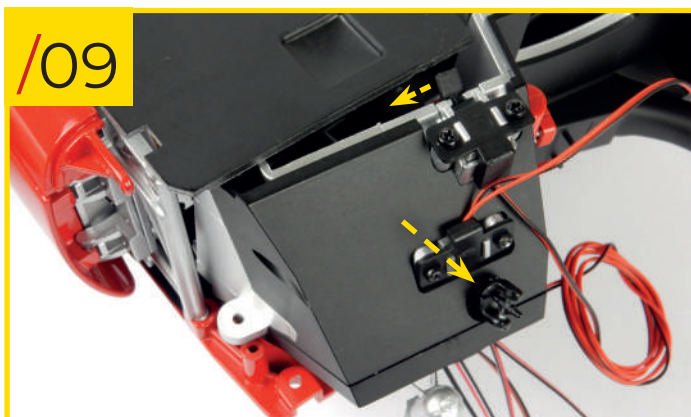

89/09 Retrieve the firewall and fit it to the rest of the model, making sure the steering column goes through the dedicated hole.

## Stage 89: Body Floor and Body

89/10 Pass the dashboard cables through the hole indicated in the photo.

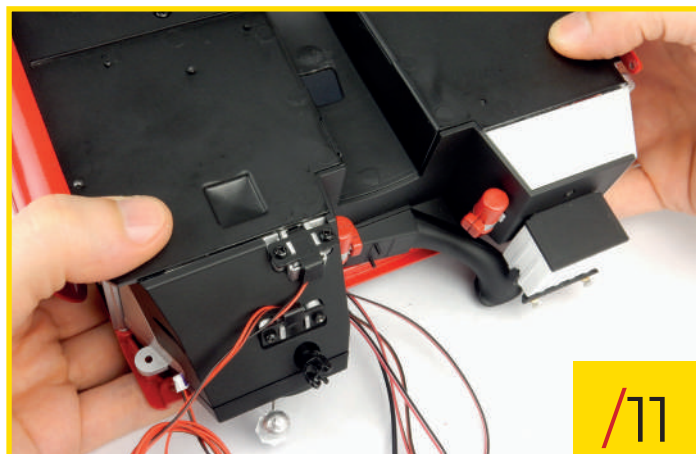
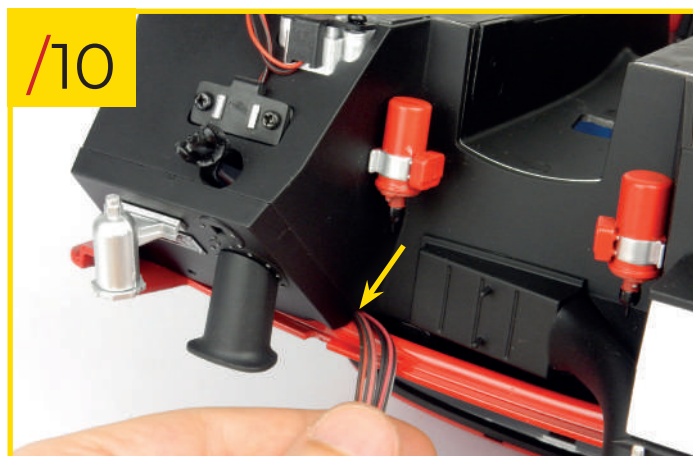

89/11 Make sure the profile of the firewall lines up with that of the body floor.

89/12 Check to make sure the holes for the screws are lined up and secure the firewall to the body using four type C screws (two on each side).

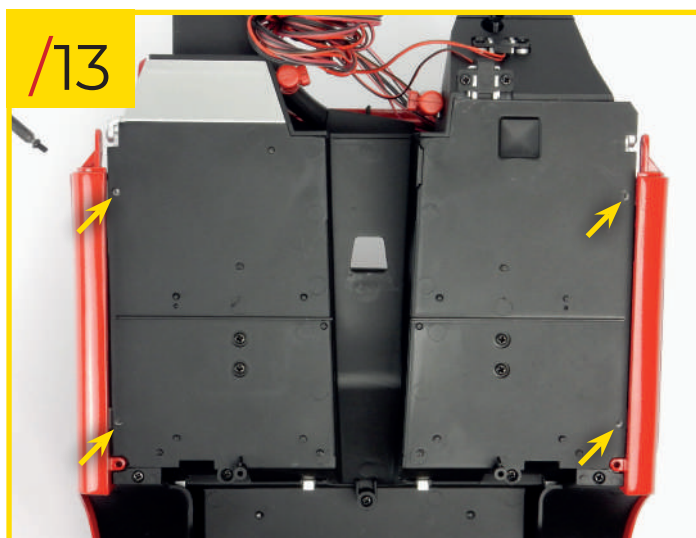
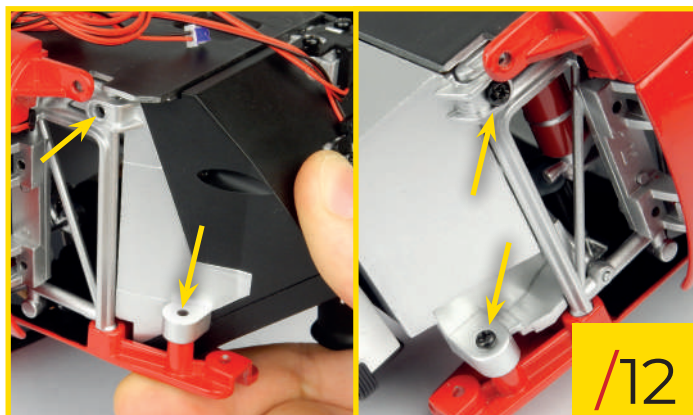

89/13 Finish securing the body floor to the body by screwing four type C screws into the holes indicated.



## Stage 89: Body Floor and Body

---

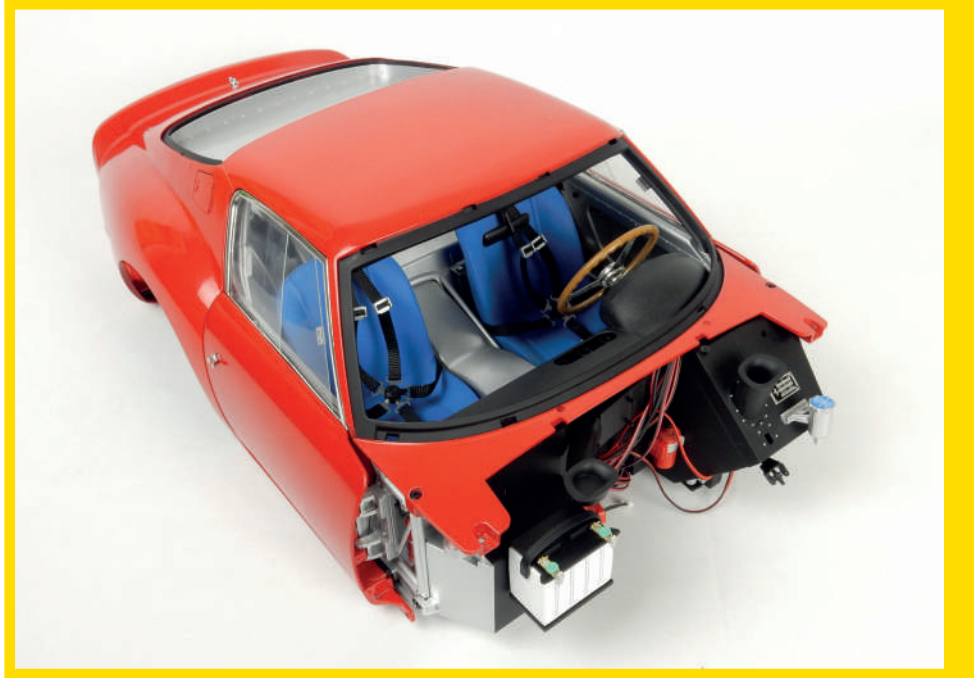

STAGE 89 IS COMPLETE  
Here's how the rear section of your model's body looks at the end of this stage. Keep it somewhere safe together with the pieces you haven't used during this session.

## Stage 90: Printed Circuit Board

In this stage you'll assemble the battery tray components that you received with stage 89 and you'll fit the printed circuit board to this assembly.



### STAGE 90 PARTS LIST

Name	Name
1 Printed circuit board	3 type B screws

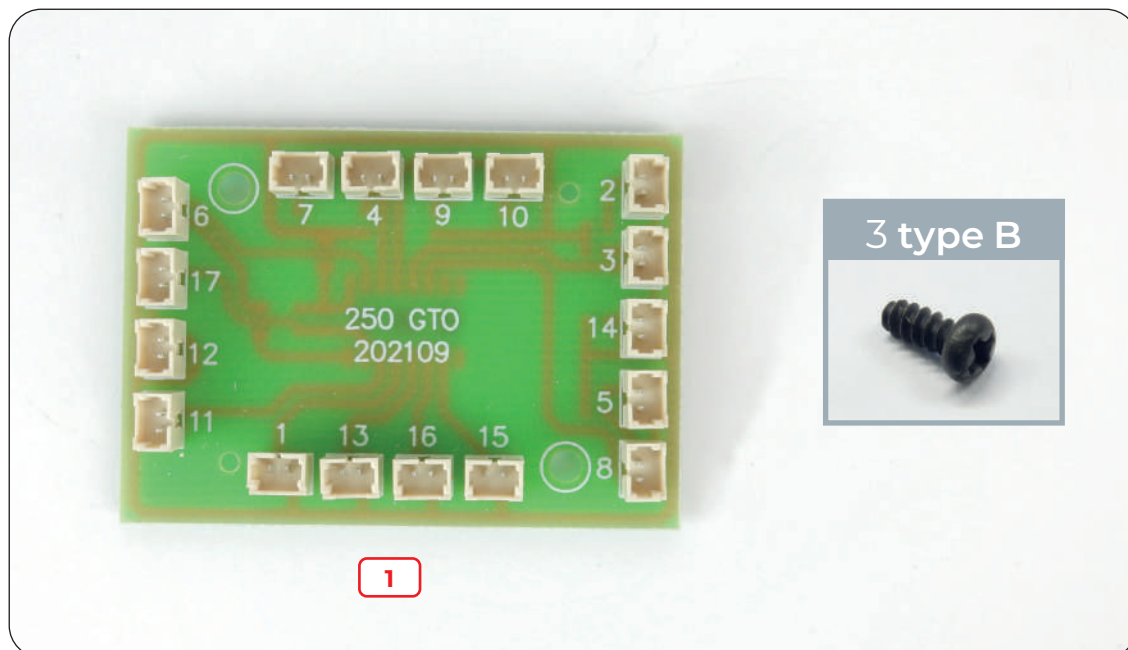

## Stage 90: Printed Circuit Board

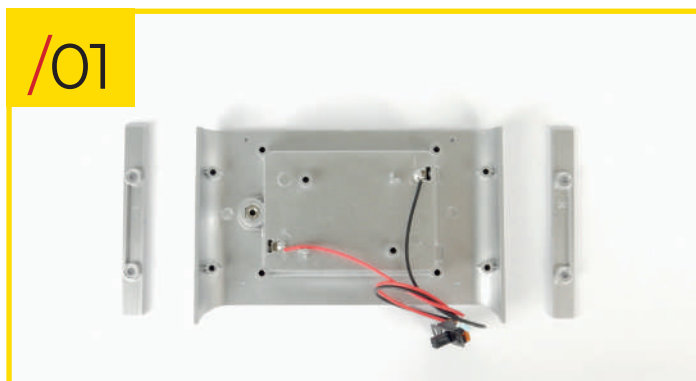

90/01 Place the pieces and screws that you received in stage 89 on your work surface: you'll need them to assemble your model's battery tray.

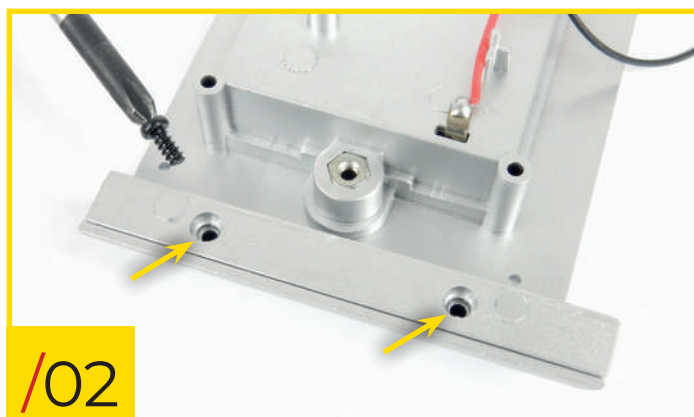

90/02 Fit the left plate (marked with the letter "L") into its position and secure it in place with two type B screws.

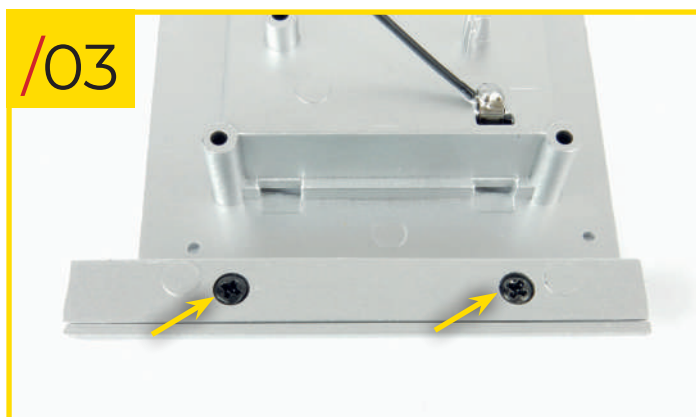

90/03 Similarly, fit the right plate (marked with the letter "R") into its position and secure it to the battery tray with two type B screws.

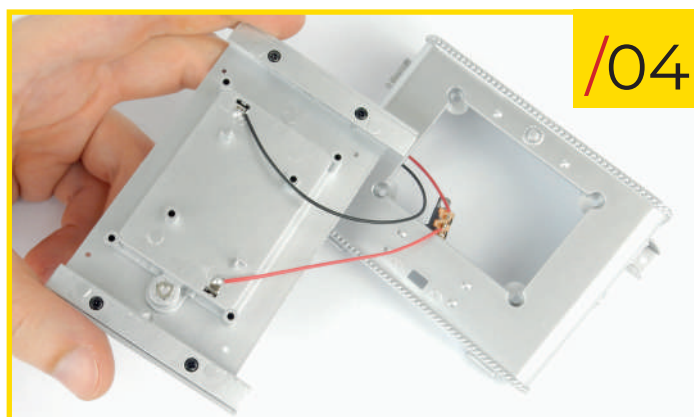

90/04 Insert the battery tray into the hole in the centre of its base. Orientate the pieces as shown in the photo.

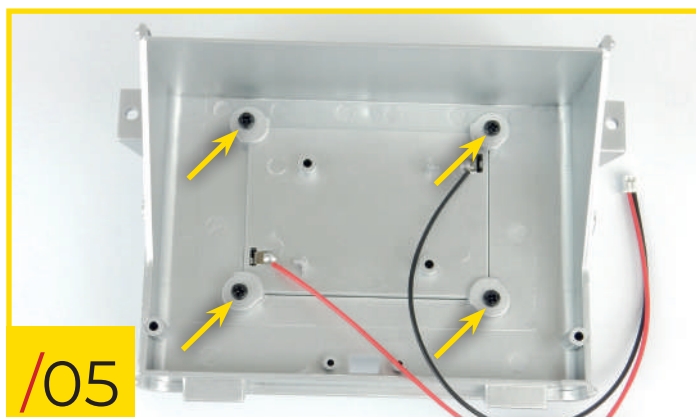

90/05 Working on the inside of the assembly, secure the pieces together by screwing four type B screws into the holes indicated.

## Stage 90: Printed Circuit Board

90/06 Fit the battery tray cable switch into the dedicated slot. Orientate the pieces exactly as shown in the photo.

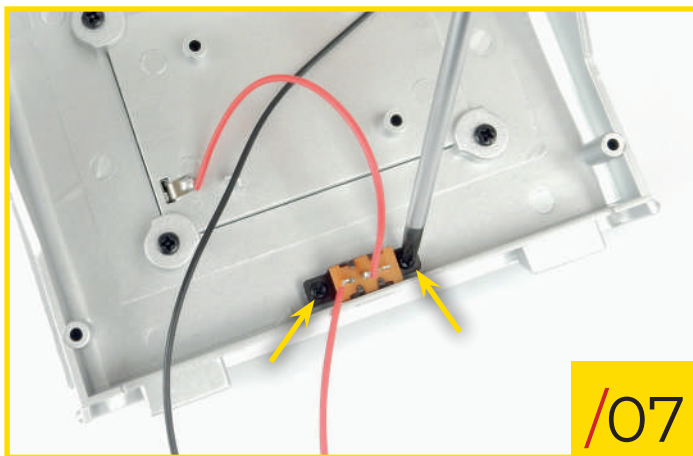
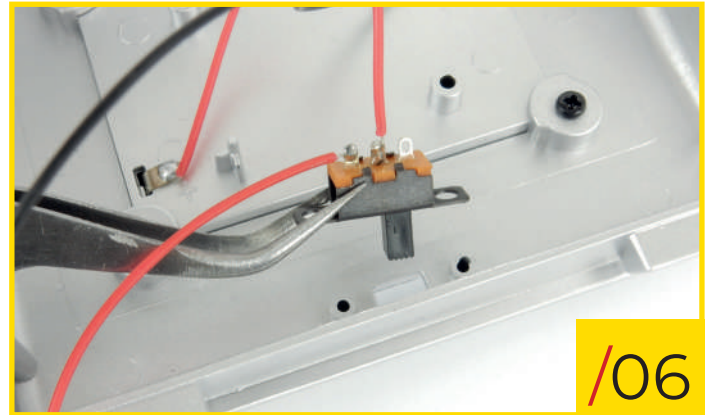

90/07 Secure the switch to the battery tray base using two type L screws.

90/08 Fit the short bracket into the position shown in the photo, insert its two studs into the dedicated holes in the battery tray base.

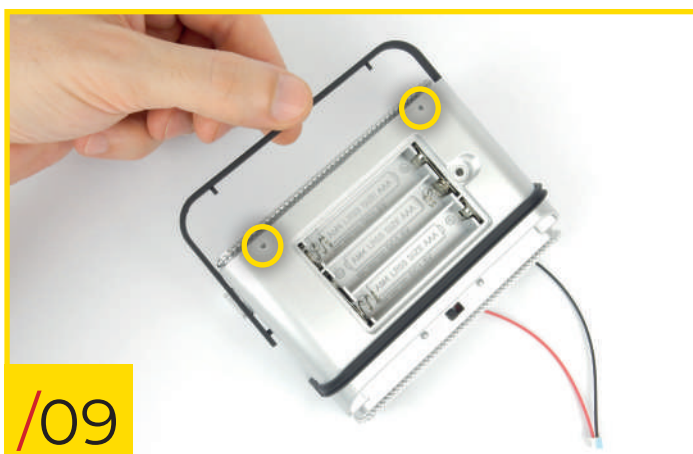
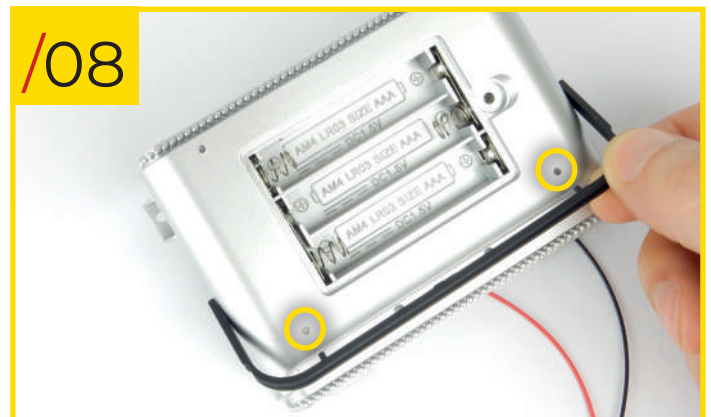

90/09 Similarly, fit the long bracket to the other side of the battery tray base.

## Stage 90: Printed Circuit Board

90/10 Fit the cover into the position shown. Slide the washer onto the cover screw and secure the cover to the rest of the battery tray assembly by screwing the screw (with the washer) into the hole indicated.

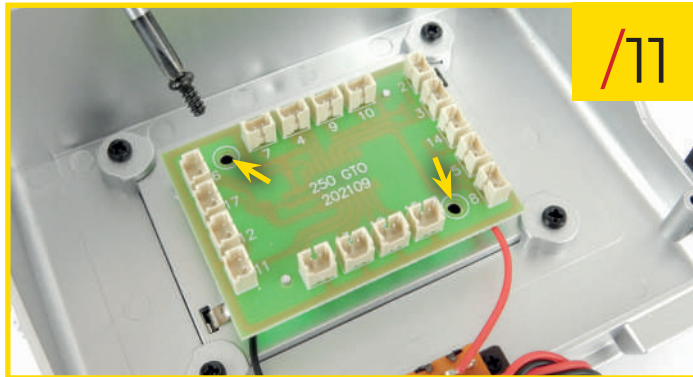

90/11 Fit the printed circuit board to the inside of the battery tray and secure it in place using two type B screws. Orientate the components exactly as shown in the photo.

90/12 Insert the switch connector into socket "17" on the circuit board.

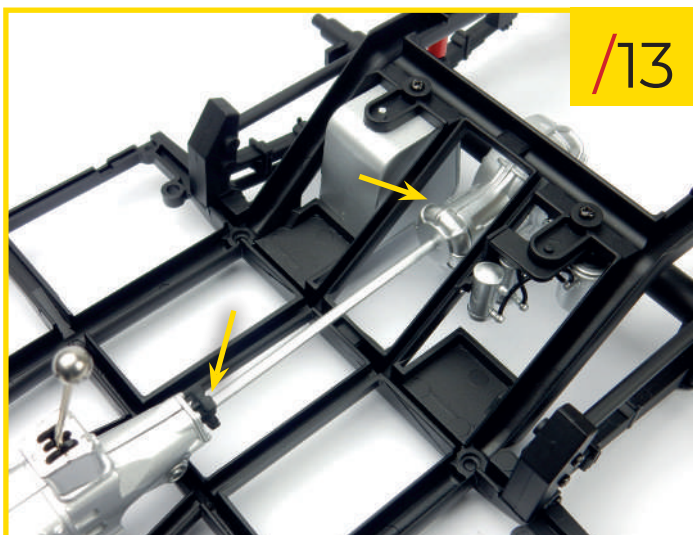
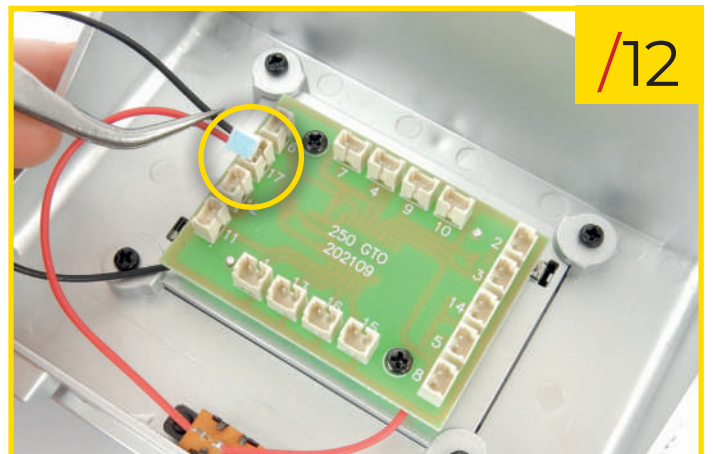

90/13 Finally, retrieve the prop shaft with the coupling that you assembled in stage 88 and fit it to the position indicated on the chassis to connect the gearbox to the differential.

## Stage 90: Printed Circuit Board

---

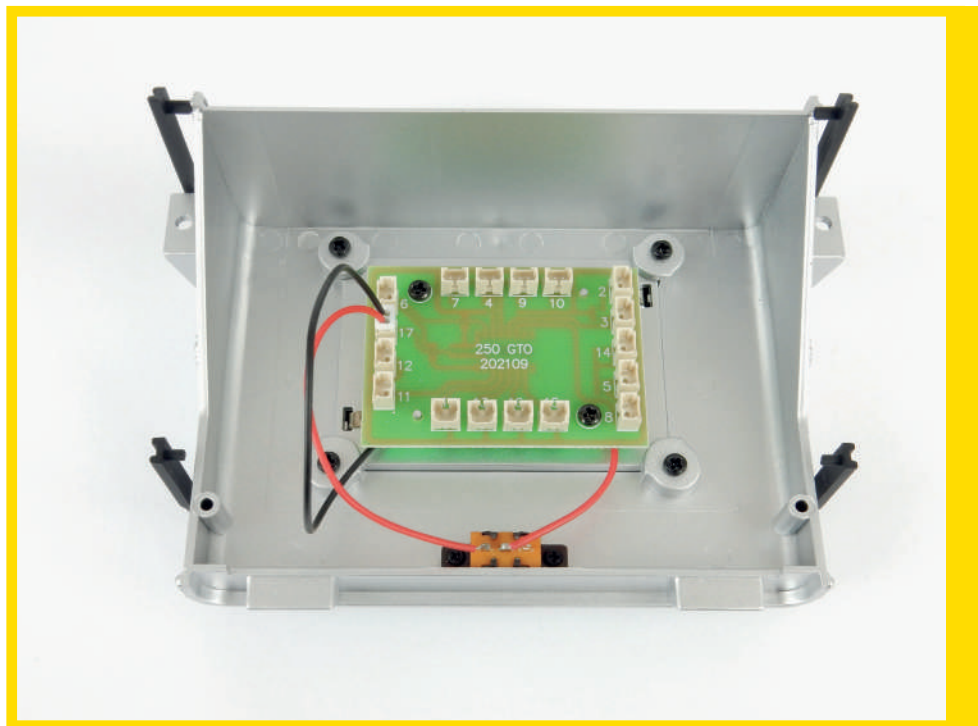

**STAGE 90 IS COMPLETE**  
Here's how the inside of your model's battery tray looks at the end of this assembly session. Keep all the parts in a safe place until they are needed.